

~~TOP SECRET~~  
[Redacted]

CORONA J

PERFORMANCE EVALUATION REPORT

MISSION 1023-1 and 1023-2

FTV 1618; J-23

22 December 1965

Approved: [Redacted]

Mgr.

Approved: [Redacted]

Mgr.

Declassified and Released by the NSA ~~TOP SECRET~~ [Redacted]

In Accordance with E. O. 12958

on NOV 26 1997

[Redacted]

~~TOP SECRET~~

## FOREWORD

This report details the performance of the payload system during the operational phase of the Program Flight Test Vehicle 1618.

Lockheed Missiles and Space Company has the responsibility for evaluating payload performance under the Systems Integration and "J" System contracts.

This document is the final payload test and performance evaluation report for Missions 1023-1 and 1023-2 which was launched on 17 August 1965.

~~TOP SECRET~~

~~TOP SECRET~~

TABLE OF CONTENTS

	Page
TITLE PAGE	
FOREWORD	i
TABLE OF CONTENTS	ii
LIST OF TABLES	iii
LIST OF ILLUSTRATIONS	iv
INTRODUCTION	1
SECTION 1 - SYSTEM PERFORMANCE	2
SECTION 2 - PRE-FLIGHT SYSTEMS TEST	5
SECTION 3 - FLIGHT OPERATIONS	17
SECTION 4 - MISSION 1023-1 RECOVERY SYSTEM	31
SECTION 5 - MISSION 1023-2 RECOVERY SYSTEM	33
SECTION 6 - MASTER (FWD) PANORAMIC CAMERA	35
SECTION 7 - SLAVE (AFT) PANORAMIC CAMERA	38
SECTION 8 - PANORAMIC CAMERA EXPOSURE	40
SECTION 9 - DIFFUSE DENSITY MEASUREMENTS	54
SECTION 10 - PERFORMANCE MEASUREMENTS	117
SECTION 11 - OBSERVED DATA	118
SECTION 12 - MISSION 1023-1 STELLAR-INDEX CAMERA	119
SECTION 13 - MISSION 1023-2 STELLAR-INDEX CAMERA	121
SECTION 14 - VEHICLE ATTITUDE	123
SECTION 15 - IMAGE SMEAR ANALYSIS	136
SECTION 16 - RADIATION DOSAGE	150
SECTION 17 - RELIABILITY	151
SECTION 18 - SUMMARY DATA	155

~~TOP SECRET~~

LIST OF TABLES

Table		Page
2-1	J-23 Environmental Test Cycle Rates	7-10
3-1	J-23 RTC Settings	19-20
3-2	Mission 1023 Cycle Rate Data	23
3-3	Clock Summary	24
3-4 & 3-5	Mission Temperature Summary	26-27
4-1	Mission 1023-1 Recovery Sequence	32
5-1	Mission 1023-2 Recovery Sequence	34
9-1	Mission 1023-1 FWD Camera Density Distribution	56-61
9-2	Mission 1023-1 AFT Camera Density Distribution	71-76
9-3	Mission 1023-2 FWD Camera Density Distribution	86-91
9-4	Mission 1023-2 AFT Camera Density Distribution	101-106
9-5	Nominal Exposure Summary	116
15-1	Mission 1023 V/h Ratio and Resolution Limits	149
17-1 & 17-2	Estimated Reliability Summary	153-154
18-1	Mission Summary	156
18-2	Performance Summary	157
18-3	Exposure - Processing Summary	158

**LIST OF ILLUSTRATIONS**

<b>Figure</b>		<b>Page</b>
1-1	Mission 1023 Inboard Profile	3
2-1	Master Camera Pre-Flight Resolution	14
2-2	Slave Camera Pre-Flight Resolution	15
3-1	Suspect Failure Area	18
3-2	PMU Gas Consumption	21
3-3 to 3-5	Temperature Data	28-30
8-1	Mission 1023-1 Solar Elevations	42
8-2	Mission 1023-1 Solar Azimuth	43
8-3	Mission 1023-2 Solar Elevations	44
8-4	Mission 1023-2 Solar Azimuth	45
8-5 to 8-12	Nominal Exposure Points	46-53
9-1 to 9-9	Mission 1023-1 FWD Camera Density Distribution	62-70
9-10 to 9-18	Mission 1023-1 AFT Camera Density Distribution	77-85
9-19 to 9-27	Mission 1023-2 FWD Camera Density Distribution	92-100
9-28 to 9-36	Mission 1023-2 AFT Camera Density Distribution	107-115
14-1 to 14-3	Mission 1023-1 Attitude Error Distributions	124-126
14-4 to 14-6	Mission 1023-1 Attitude Rate Distributions	127-129
14-7 to 14-9	Mission 1023-2 Attitude Error Distributions	130-132
14-10 to 14-12	Mission 1023-2 Attitude Rate Distributions	133-135
15-1 to 15-2	Mission 1023-1 V/h Error Distribution	137-138
15-3 to 15-6	Mission 1023-1 Resolution Limit Distributions	139-142
15-7 to 15-8	Mission 1023-2 V/h Error Distribution	143-144
15-9 to 15-12	Mission 1023-2 Resolution Limit Distributions	145-148

~~TOP SECRET~~ [REDACTED]

## INTRODUCTION

This report presents the final performance evaluation of Missions 1023-1 and 1023-2 of the Corona Program. The purpose of this report is to define the performance characteristics of the J-23 payload system, to identify the source of in-flight anomalies and recommend the appropriate corrective action.

The performance evaluation was jointly conducted by representatives of Lockheed Missiles and Space Company (LMSC) and ITEK at the facilities of NPIC and AFSPPL. The off-line evaluation using Corona engineering photography acquired over the United States was performed at the individual contractors plants.

The quantitative data used for this report is obtained from government organizations. The diffuse density data, visual RES values and MTF/AIM resolution are produced by AFSPPL. The vehicle attitude error values, frame correlation times are made at NPIC who also supply the Processing Summary and MTF/AIM resolution reports published by [REDACTED]

Computer programs developed by A/P are utilized to calculate and plot the frequency distribution of the various contributors to image smear to permit analysis and correlation of the conditions of photography to the information content and quality of the acquired pictures. Computer analysis of the exposure, processing and illumination data provides the necessary data to analyze the exposure criteria selected for the mission.

~~TOP SECRET~~ [REDACTED]

~~TOP SECRET~~ [REDACTED]

SECTION 1  
SYSTEM PERFORMANCE

A. MISSION OBJECTIVES

The payload section of Mission 1023, placed into orbit by Flight Test Vehicle # 1618 and SLV-2A booster #449, consisted of two panoramic cameras, two Stellar-Index cameras, two Mark 5A recovery capsules and a space structure to enclose the cameras and provide mounting surfaces for all equipments. Figure 1-1 presents an inboard profile of the J-23 payload system. This Corona "J" system is designed to acquire search and reconnaissance photography of selected areas of the earth from orbital altitudes. The planned mission was a nine day photographic period with no inactive period.

B. MISSION DESCRIPTION

The payload was launched from Vandenberg Air Force Base (VAFB) at 2059:57 Z (1:59:57 PDT) on 17 August 1965. Ascent and injection were normal and the achieved orbit was within nominal tolerances. Tracking and command support was effected by the Air Force Satellite Control Facility consisting of tracking and command stations at [REDACTED] under central control of the Satellite Test Center at Sunnyvale, California. Mission 1023-1 consisted of five days operation and was completed by air recovery on 22 August 1965. Mission 1023-2 was completed with an air recovery on 26 August 1965 following four days of photographic operations.

The comparison of the planned and actual orbit parameters is tabulated as follows:

~~TOP SECRET~~ [REDACTED]

SCHEMATIC INBOARD PROFILE - CORONA J SYSTEM

MISSION 1023

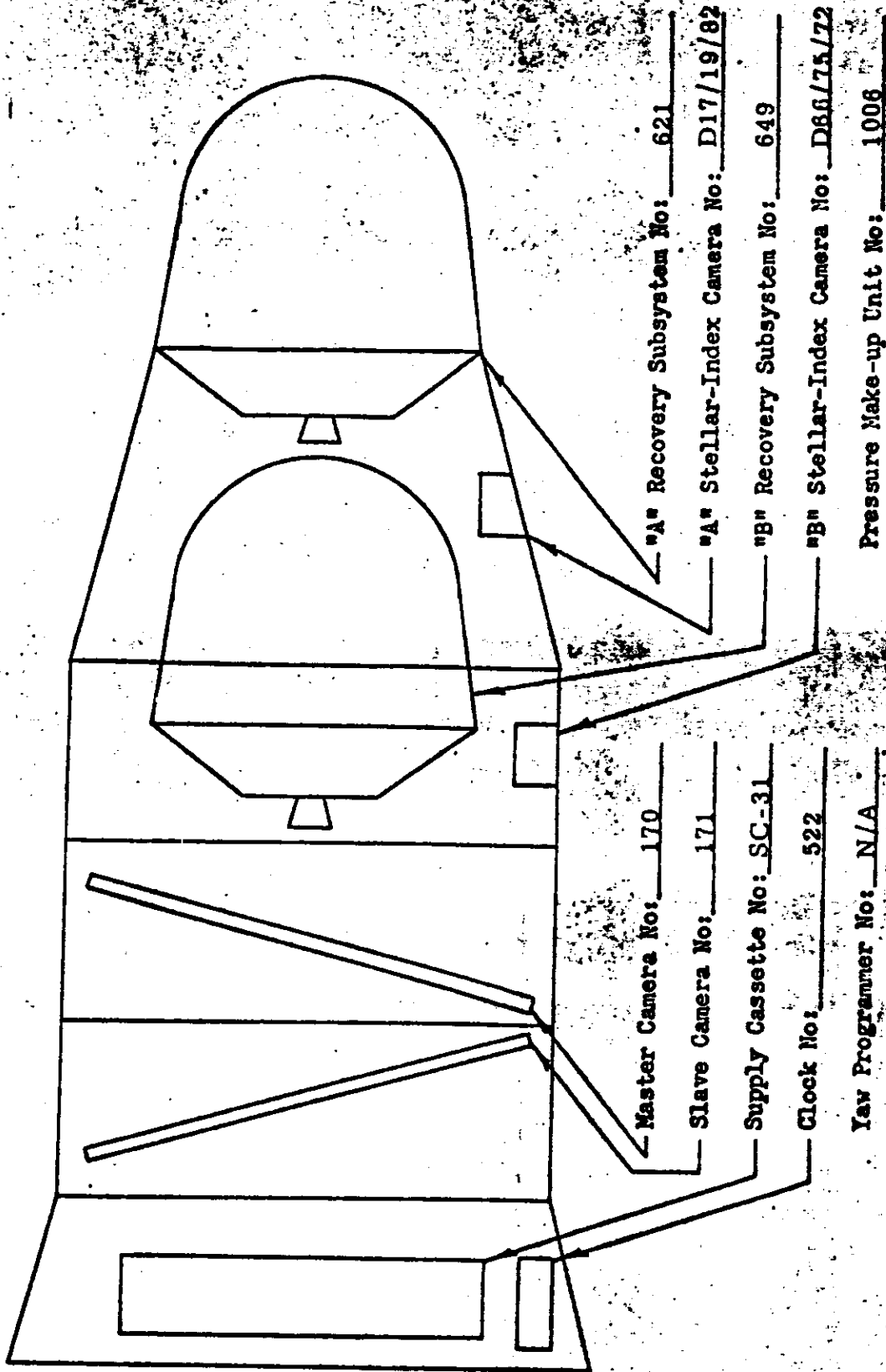

FIGURE 1

~~TOP SECRET~~



**ORBITAL PARAMETERS**

<u>Parameter</u>	<u>Predicted</u>	<u>Orbit 1 Actuals</u>
Period (Min.)	90.50	90.47
Perigee (N. M.)	100.00	97.98
Apogee (N. M.)	226.66	226.45
Inclination (Deg.)	70.00	70.04
Perigee Latitude (Deg. N.)	22.39	24.09
Eccentricity	0.01759	0.01782

Orbit Adjust System experiments were conducted after the second recovery and were apparently successful.

**C. PANORAMIC CAMERAS**

The Master panoramic camera operated satisfactorily until pass 102. Failure occurred on pass 102 during a programmed 147 cycle operation. Intermittent operations on passes 133, 134, and 135 occurred after the initial failure.

The Slave panoramic camera operated normally throughout the flight.

**D. STELLAR-INDEX CAMERAS**

The Mission 1023-1 Stellar/Index camera operated normally throughout the mission. The Mission 1023-2 Stellar/Index camera operated normally until rev 102. Further operation was precluded by the Master Camera failure.

**E. OTHER SUB-SYSTEMS**

The clock, instrumentation, command and thermal control sub-systems performed satisfactorily through both missions.

**F. CONCLUSIONS**

Mission 1023-1 and 1023-2 achieved the objective of acquiring high quality search and reconnaissance photography from orbital altitudes.

## SECTION 2

### PRE-FLIGHT SYSTEMS TESTS

#### A. ENVIRONMENTAL TESTING

##### 1. Test Objective

As a standard procedure, the J payload systems are subjected to thermal/altitude environmental testing which simulates orbital environment. One of the purposes of this test is to demonstrate the system susceptibility to corona discharge. Such discharge fogs the film thus degrading the operational photography.

##### 2. Test Summary

The J-23 payload system was subjected to an environmental test in TASC chamber at Sunnyvale from 1 April 1965 to 4 April 1965. The test consisted of 3 days of operation in each of the "A" and "B" modes. The payload system was only operated during the daytime.

Both panoramic cameras operated satisfactorily throughout the test with the exception of film movement on the Master camera. This movement was observed when the seven second relays dropped out. This condition was present several times only in the "B" mode.

Both the "A" and "B" recovery sequences were satisfactory with proper transfer to the "B" phase during the cut and wrap operation. A deactivate sequence was conducted between the "A" and "B" phase with all functions operating satisfactorily.

Both the "A" and "B" phase Stellar/Index cameras operated satisfactorily. The clock and pressure make-up unit operation appeared normal throughout the test.

##### 3. Panoramic Camera Performance

Both panoramic cameras operated satisfactorily throughout the test. The only dynamic camera anomaly occurred at camera shut-down.

~~TOP SECRET~~

When the seven second relay dropped out after the camera off command, the horizon idler on the master unit indicated payload movement. This condition was present on several occasions during the "B" phase only.

For both instruments the cycle periods were approximately 0.5 to 1.5% slower than predicted during the "A" phase and 0.5 to 2.0% faster than the predicted during the "B" phase. All cycle periods in both the "A" phase and "B" phase were less than 3% from the predicted for both instruments as shown in Table 2-1.

The cut and wrap operation was normal, with both instruments operating 4 cycles and both lens stopped in the stowed position. A deactivate command was given between the "A" and "B" phase with both instruments operating 6 cycles and the lens stopping in the stowed position.

Minor start-up corona marking was produced by both panoramic cameras. The frequency and intensity of this marking was within the acceptable level hence the cameras were recommended for flight.

#### 4. Stellar-Index Camera Performance

The Stellar/Index camera operated satisfactorily throughout the "A" phase with normal camera slewing during the cut and wrap sequence.

The "B" phase Stellar/Index camera operated satisfactorily with normal camera slewing during the simulated "B" recovery sequence.

The "A" bucket stellar fiducials are poor but acceptable and the index camera is acceptable. The "B" bucket index is acceptable.

The "B" bucket stellar contained corona marking on 4.6% of the total frames to a density higher than the 0.40 maximum density allowable. The quantity is acceptable but the density does not meet the acceptance criteria.

It was recommended that this requirement be waived and the entire system accepted for flight for the following reasons:

1. This corona marking occurred only when PMU was off.

~~TOP SECRET~~

J-23 170/171 ENVIRONMENTAL TEST CYCLE RATES 04-01-65

REV/MODE	RAMP	T.U.R.	INST 170			INST 171			170/171 DIFF.
			ACT.	NOM.	DEV.	ACT.	NOM.	DEV.	
1 A	7 7	382	3.550	3.534	-0.45	3.585	3.530	-1.54	0.99
1 A	7 7	2201	2.560	2.537	-0.90	2.577	2.529	-1.89	0.66
2 A	4 1	1420	2.220	2.203	-0.78				
2 A	4 1	1605				2.220	2.184	-1.67	
2 A	4 1	2125	2.185	2.175	-0.46	2.205	2.176	-1.32	0.92
4 A	7 7	2275	2.573	2.568	-0.20	2.590	2.560	-1.17	0.66
4 A	8 2	340	5.250	5.192	-1.12	5.300	5.208	-1.76	0.95
5 A	8 2	1710	2.230	2.216	-0.65				
5 A	8 2	2250				2.240	2.251	0.51	
5 A	11 1	1460	2.713	2.690	-0.86	2.730	2.682	-1.77	0.63
6 A	11 1	2040	2.283	2.289	0.26	2.305	2.281	-1.05	0.96
6 A	5 8	1090	2.740	2.714	-0.97	2.760	2.706	-1.99	0.73
6 A	5 8	1445	2.540	2.514	-1.05	2.543	2.506	-1.49	0.12
7 A	7 7	1180	2.930	2.901	-1.00	2.940	2.894	-1.58	0.34
7 A	7 7	1590	2.593	2.583	-0.40	2.600	2.575	-0.98	0.27
8 A	7 7	2530	2.733	2.732	-0.04	2.737	2.724	-0.46	0.15
8 A	4 1	1015	2.797	2.763	-1.22	2.807	2.756	-1.86	0.36
8 A	4 1	1750	2.188	2.176	-0.57				
9 A	4 1	2620				2.318	2.306	-0.53	
9 A	4 1	3210	3.400	3.415	0.44	3.405	3.411	0.17	0.15
9 A	11 1	885	4.665	4.599	-1.44	4.690	4.606	-1.83	0.54
10 A	11 1	1880	2.295	2.283	-0.54	2.305	2.275	-1.34	0.44

TABLE 2-1

REV/MODE	RAMP	T.U.R.	INST 170			INST 171			170/171 DIFF.	
			ACT.	NOM.	DEV.	ACT.	NOM.	DEV.		
10	A	11 1	2970	4.365	4.418	1.19	4.395	4.423	0.62	0.69
10	A	7 7	235	3.605	3.599	-0.16	3.630	3.596	-0.94	0.69
11	A	7 7	2005	2.500	2.493	-0.27	2.510	2.485	-0.99	0.40
11	A	7 7	2435	2.623	2.661	1.42	2.627	2.653	0.98	0.15
12	A	8 2	1150	3.093	3.049	-1.45	3.107	3.042	-2.12	0.45
12	A	8 2	1851				2.240	2.203	-1.68	
12	A	8 2	840	3.830	3.783	-1.23	3.860	3.782	-2.07	0.78
13	A	4 1	2630	2.355	2.330	-1.09	2.350	2.322	-1.22	-0.21
13	A	11 1	1970	2.283	2.276	-0.30	2.305	2.268	-1.62	0.96
14	A	11 1	3075	4.890	4.916	0.54	4.955	4.928	-0.54	1.33
1	B	7 7	385	3.500	3.532	0.92	3.530	3.529	-0.03	0.86
01	B	7 7	2210	2.537	2.540	0.13	2.550	2.533	-0.69	0.51
02	B	4 1	1425	2.200	2.202	0.09				
02	B	4 1	1605				2.205	2.184	-0.98	
02	B	4 1	2125	2.178	2.175	-0.14	2.190	2.176	-0.63	0.55
04	B	7 7	2275	2.533	2.568	1.36	2.543	2.560	0.67	0.39
04	B	8 2	335	5.060	5.204	2.76	5.120	5.220	1.92	1.19
05	B	8 2	1725	2.205	2.214	0.43				
05	B	8 2	2245				2.248	2.248	-0.02	
05	B	11 1	1460	2.667	2.690	0.85	2.677	2.682	0.20	0.37
06	B	11 1	2040	2.255	2.289	1.49	2.268	2.281	0.57	0.58
06	B	5 8	1090	2.670	2.714	1.61	2.700	2.706	0.23	1.12

TABLE 2-1

REV/MODE	RAMP	T.U.R.	INST 170			INST 171			170/171 DIFF.	
			ACT.	NOM.	DEV.	ACT.	NOM.	DEV.		
06	B	5 8	1445	2.495	2.514	0.74	2.500	2.506	0.23	0.20
07	B	7 7	1180	2.870	2.901	1.07	2.877	2.894	0.59	0.24
07	B	7 7	1580	2.540	2.588	1.85	2.540	2.580	1.55	-0.
07	B	7 7	2530	2.687	2.732	1.64	2.687	2.724	1.38	-0.
08	B	4 1	1015	2.730	2.763	1.20	2.730	2.756	0.94	-0.
08	B	4 1	1750	2.163	2.176	0.58				
09	B	4 1	2620				2.283	2.306	0.98	
09	B	4 1	3210	3.343	3.415	2.11	3.340	3.411	2.07	-0.09
09	B	11 1	885	4.560	4.599	0.84	4.580	4.606	0.56	0.44
10	B	11 1	1875	2.263	2.284	0.91	2.265	2.276	0.47	0.09
10	B	11 1	2965	4.265	4.396	2.97	4.295	4.400	2.39	0.70
10	B	7 7	140	3.570	3.624	1.50	3.580	3.621	1.14	0.28
11	B	7 7	1910	2.450	2.492	1.68	2.460	2.484	0.96	0.41
11	B	7 7	2280	2.530	2.570	1.57	2.530	2.563	1.27	-0.
11	B	8 2	1154	3.060	3.039	-0.70	3.080	3.032	-1.58	0.65
12	B	8 2	846	3.800	3.767	-0.87	3.820	3.766	-1.45	0.53
13	B	4 1	2631	2.350	2.331	-0.81	2.350	2.323	-1.15	-0.
13	B	11 1	1976	2.280	2.277	-0.15	2.290	2.269	-0.94	0.44
15	B	5 8	1931	2.380	2.393	0.56	2.400	2.385	-0.61	0.84
15	B	5 8	3121	2.880	2.887	0.24	2.900	2.880	-0.70	0.69
15	B	8 2	1771	2.200	2.211	0.52	2.240	2.206	-1.56	1.82
15	B	8 2	2621	2.750	2.766	0.56	2.780	2.758	-0.79	1.09

TABLE 2-1

~~TOP SECRET~~

REV/MODE	RAMP	T.U.R.	INST 170			INST 171			170/171 DIFF.	
			ACT.	NOM.	DEV.	ACT.	NOM.	DEV.		
16	B	8 2	0	5.580	5.586	0.11	5.600	5.609	0.16	0.36
16	B	8 2	0	5.580	5.586	0.11	5.620	5.609	-0.19	0.72

DEV. AND DIFF. ARE IN PERCENT  
 THE (-) SIGN INDICATES THAT THE INST IS SLOWER THAN  
 PREDICTED OR THAT INST 1 IS SLOWER THAN INST 2

TABLE 2-1

~~TOP SECRET~~

2. Even if the PMU were to fail in flight, an exposure analysis shows that 6th magnitude stars would still be discernable above the corona level encountered.

5. Instrumentation Performance

Film correlation between the film footage pots and the cycle counter on both instruments was satisfactory throughout the test. The only instrumentation discrepancies observed during the test were:

1. Master instrument temp sensor No. 13 was approximately 15° F lower than average instrument No. 1 temperature throughout the test.

2. Commutated channel 13 exhibited stray voltage on several commutator points during orbit 2 of the "B" phase. Some instrument monitor points were driven out of band low and the plus calibrate was driven out of band high. However, the tape recorder output of channel 13 did not contain this anomaly, and this condition was attributed to a Sanborn recorder problem.

6. Pressure Environment

The pressure make-up system operated satisfactorily throughout the test. The maximum pressure attained with the PMU on was approximately 72 microns during an instrumentation operation. The minimum pressure attained during the test was approximately 1.6 microns. The table below shows the test pressure environment during non-operate periods.

PRESSURE MICRONS

	Chamber	Alphatron #1	Alphatron #2
Day 1	.017	10.0	9.0
Day 2	.012	6.0	6.0
Day 3	.014	6.0	4.0
Day 4	.010	3.6	2.9
Day 5	.012	5.3	4.6
Day 6	.012	2.6	1.7

The average gas consumption was approximately 6.7 lbs/minute of operate time.



7. Temperature Environment

A tabulation of the temperature environment encountered during the test is included in the table below.

AVERAGE TEMPERATURE ENVIRONMENT

<u>A PHASE</u>	<u>Orbit 1</u>	<u>Orbit 14</u>		
Master Instrument	69	69		
Slave Instrument	61	62		
<u>B PHASE</u>	<u>Orbit 1</u>	<u>Orbit 8</u>	<u>Orbit 16</u>	
Master Instrument	70	92 (Max)	72	
Slave Instrument	63	93 (Max)	71	

8. Clock Performance

The clock unit operated properly throughout the test with the following errors observed:

CLOCK PERFORMANCE

	<u>IRIG "C"</u>				<u>CLOCK</u>	<u>ERRORS</u>	
	<u>Rev</u>	<u>Day</u>	<u>Hr.</u>	<u>Min</u>	<u>Sec.</u>	<u>(Seconds)</u>	<u>(Seconds)</u>
1	91	08	30	39.930	307538.848	--	
6	92	08	37	55.730	394369.626	-0.012	
11	93	07	57	25.570	478344.477	-0.011	
14	93	13	07	02.890	496911.790	-0.018	
1	94	08	00	22.560	308699.242	--	
6	95	08	57	56.500	398553.195	+ .013	
16	96	15	57	48.820	510145.496	- .006	

## B. RESOLUTION TEST

Resolution and theodolite tests of the J-23 system were completed on 22 April, 1965. Results of the thru-focus resolution tests of pan instruments 170 and 171 show the following characteristics:

### MASTER PAN INSTRUMENT NO. 170

Maximum high contrast resolution 206 lines/mm at .000 focal position.

Maximum low contrast resolution 116 lines/mm at .000 focal position

### SLAVE INSTRUMENT NO. 171

Maximum high contrast resolution 179 lines/mm at .001 focal position

Maximum low contrast resolution 108 lines/mm at .001 focal position.

The resolution test data for both instruments as shown in Figures 2-1 and 2-2, has been reviewed and appears normal in all respects. The demonstrated resolution performance meets the system requirements specification.

## C. LIGHT LEAK TEST

This system was subjected to the following test conditions:

The light leak test was conducted on 7 May 1965 using a 15 minute soak at a distance of 24 inches producing approximately 2000 foot candles. With the system sitting on blocks, nose up, the light bank was raised by crane for exposing both top and bottom of the "A" SRV-Fairing Interface. With the light bank on the floor, soaks were then performed on both sides of the system horizon optics, and directly into the main door openings.

After these 5 soaks, 15 cycles of instrument operation transferred all film between the supply and T/U cassettes into the T/U cassette. All test film, approximately 40 cycles, was retrieved and processed. 4401 film was used.

~~TOP SECRET~~

PRE-FLIGHT DYNAMIC RESOLUTION

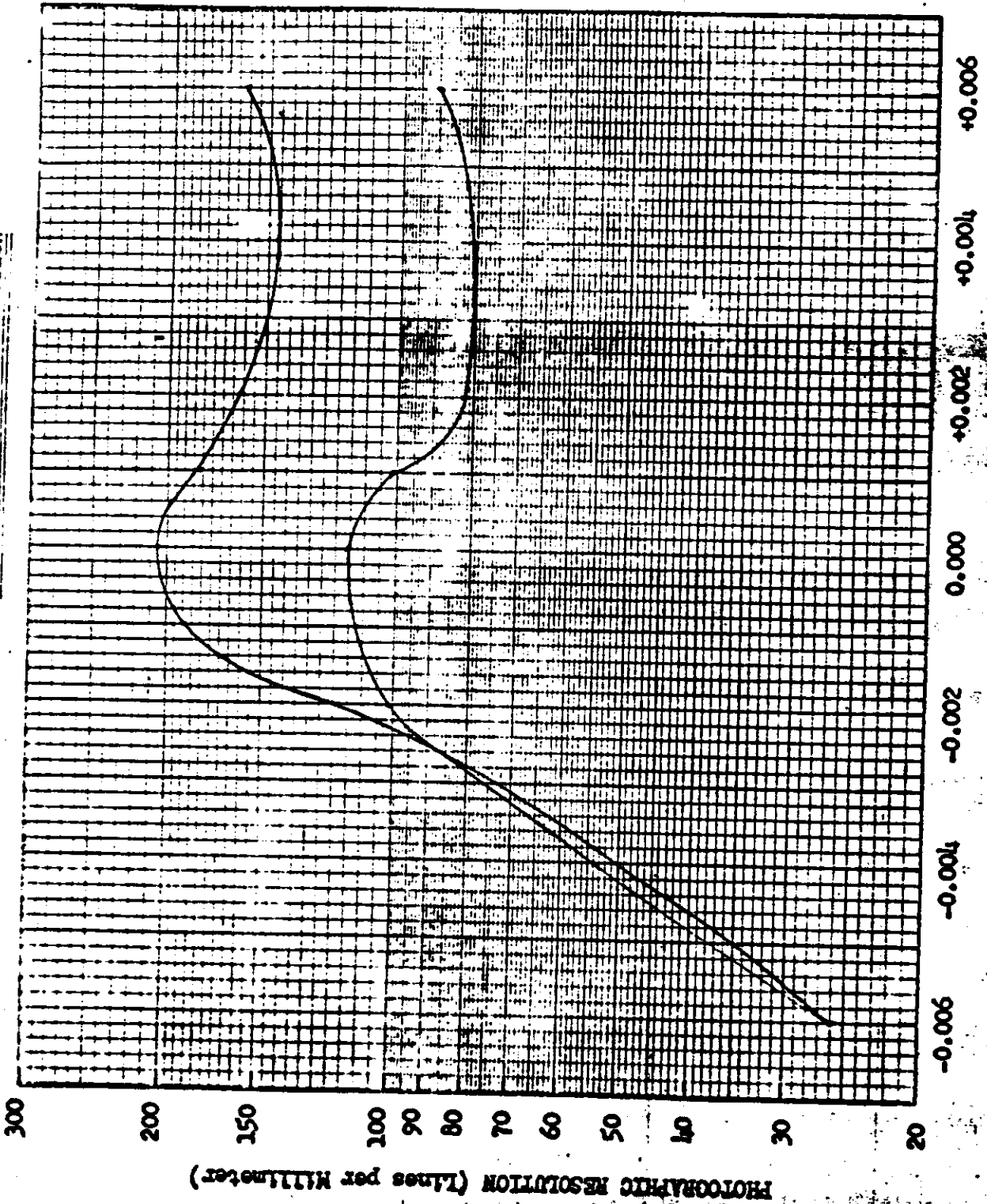

Camera No: 170  
Payload No: J-23  
Resolution ( $1/\text{mm}$ ): 206  
High Contrast: 206  
Low Contrast: 116  
Film Type: 3604  
Test Date: 4/22/65

~~TOP SECRET~~

THROUGH FOCUS INCREMENTS (Inches)  
FIGURE 2-1

TOP SECRET

PRE-FLIGHT DYNAMIC RESOLUTION

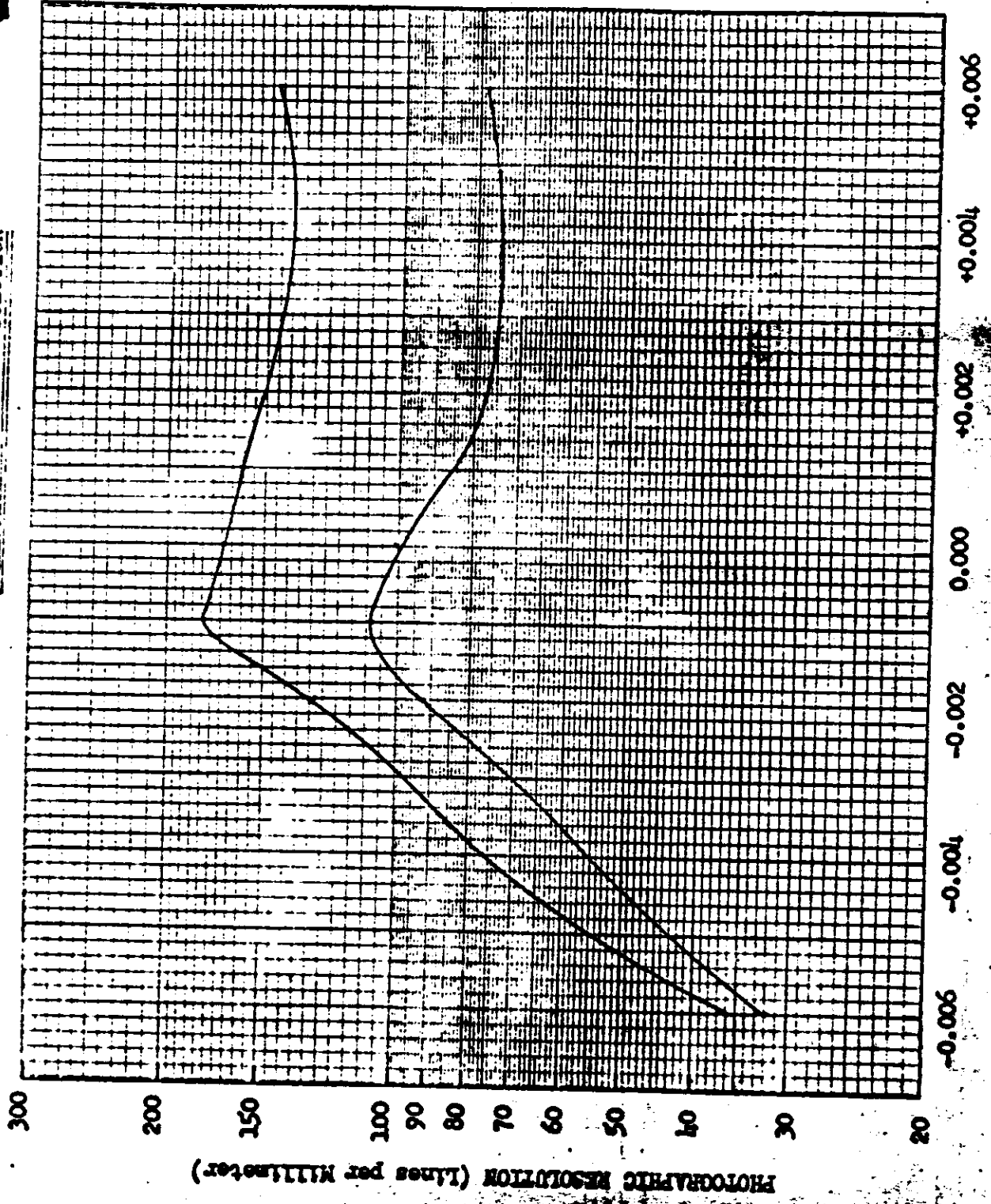

Camera No: 171  
Payload No: J-23  
Resolution (1/mm): 179  
High Contrast: 179  
Low Contrast: 108  
Fila Type: 31014  
Test Date: 4/22/65

THROUGH FOCUS INCREMENTS (Inches)

FIGURE 2-2

TOP SECRET

~~TOP SECRET~~

Examination of the processed film revealed the usual handling marks plus one small fogged area. Since this area was traced to the inside of the "B" bucket during the soak, it was concluded to have resulted from some source other than the soak.

J-23 system is recommended for flight without further light leak testing.

#### D. FLIGHT LOADING AND CERTIFICATION

Film from J-23 pad run and flight readiness was examined at VAFB on 12 August 1965. No difference in system performance could be detected between this film and film from previous operations at A/P. All data was present and acceptable. All scratch marks found were outside the format areas. No appreciable banding was found.

Some slight minus density longitudinal streaks were found, as before, where the fogging density was fairly uniform across the film. It is doubtful that these streaks could be detected in the random densities of a ground scene.

Most of the film samples were badly stained in processing. It is recommended that steps be taken to checkout the people and equipment responsible for this procedure to insure adherence to the applicable TP.

J-23 has been and is an exceptionally trouble free system and meets all established criteria for flight readiness.

~~TOP SECRET~~

~~TOP SECRET~~

### SECTION 3

#### FLIGHT OPERATIONS

##### A. INSTRUMENTATION AND COMMAND PERFORMANCE

All Instrumentation System functions operated properly throughout both missions. All monitors also operated properly.

It was determined from Rev 2 tracking data that the orbit perigee altitude was approximately two miles lower than predicted pre-flight. As a result of this, a change in V/h ramp amplitude was made on Rev 7 at [REDACTED]. This V/h ramp setting, as made on Rev 7, provided acceptable V/h ramp-to-orbit match for the balance of both missions.

V/h ramp-to-orbit match was well below the five percent allowable mismatch figure during both missions except on very high latitude operations (above 69 degrees north descending).

On pass 102, the system was in a programmed intermix OFF emergency operate mode with a 147 cycle programmed operation. Cycle counter data indicated completion of 34 of the programmed 147 cycles. An engineering pass was taken on pass 104 confirming failure of the Master camera. Neither the transport or scan functions operated. Telemetry data indicated no operate signal was received by the camera operate relays. A series of command combinations were tried, without success, in an attempt to isolate and program around the faulty component or components. A schematic of the primary suspect area is contained in Figure 3-1. Table 3-1 is a tabulation of the command settings from rev 101 through the end of the mission.

In all of the combinations of stereo and mono No. 1 operations tried on engineering passes, a signal was verified to the S/I, T/M enable (ref. Figure 3-1). At these same times no operate signal was observed at the instrument No. 1 operate relays or the PMU operate relays.

Sufficient operate time was logged in a mono 1 mode to significantly decrease the PMU gas supply had an operate signal been received by the PMU system. Figure 3-2 is a plot of the PMU consumption. The solid line indicates the consumption during stereo operation and the dash lines show the consumption with the mono No. 1 operate time added.

~~TOP SECRET~~

TOP SECRET

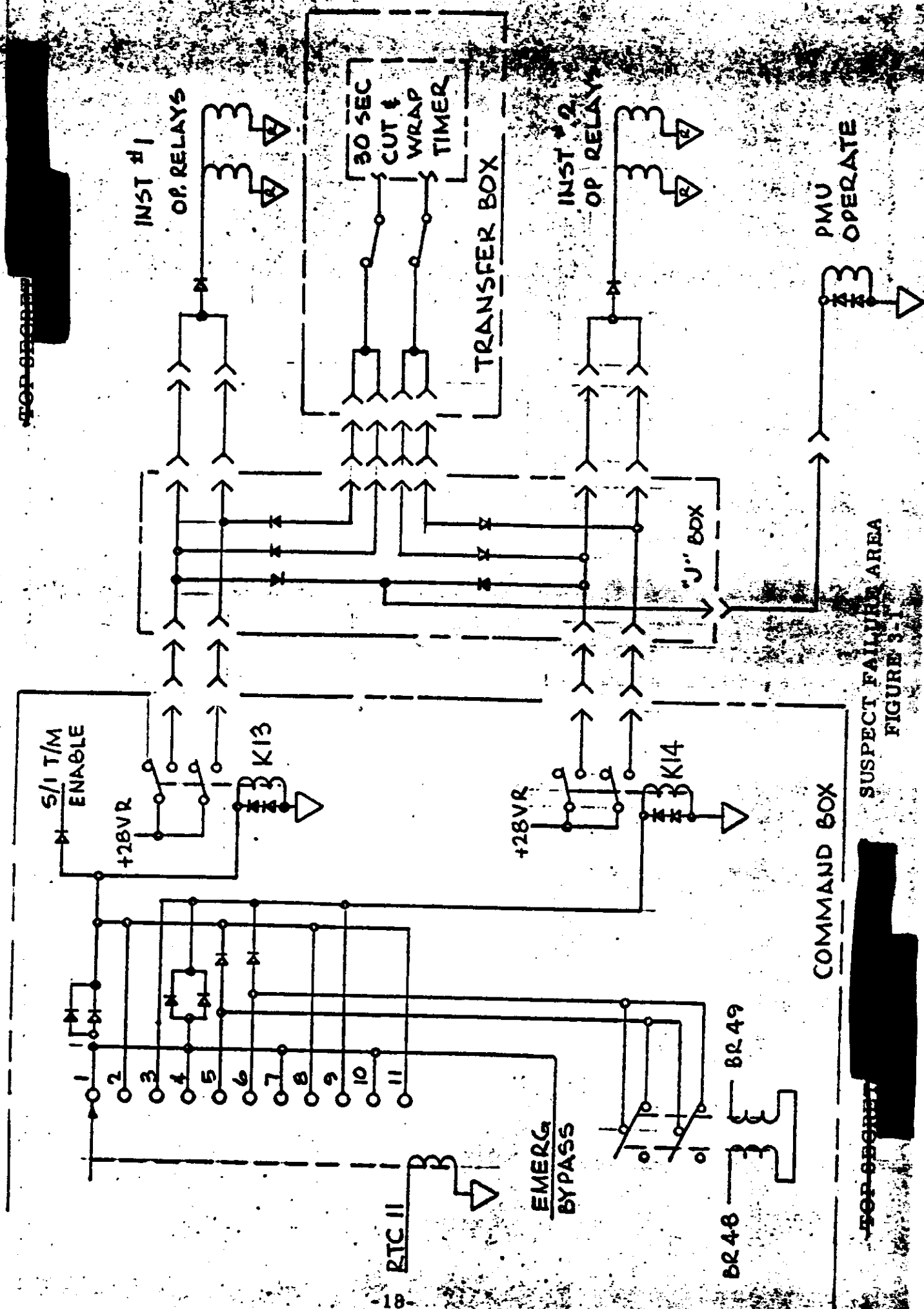

SUSPECT FAILURE AREA  
FIGURE 3-1

TOP SECRET

**TABLE 3-1**  
**1618 J-23 RTC SETTINGS**

Master	Operation	6	8	9	10	11	12	15	Remarks
101	Normal	7	3	9	6	7	7	4	Stereo - On
102	34 for 147	7	3	1	6	7	8	4	Stereo - On (Emerg)
103	Failed	7	3	1	6	7	9	4	Stereo - On (Emerg)
104	Failed	7	3	3	6	7	11	4	Stereo - On
105	Failed	7	3	2	6	1	2	4	Stereo - On
106	Failed	7	3	2	6	2	5	4	Mono -1 - On
107	Failed	7	3	5	6	4	8	4	Stereo - Off
108	Failed	7	3	5	6	4	9	4	Stereo - On
109	Failed	7	3	8	6	4	4	4	Stereo - Off
110	Failed	7	3	9	6	4/8	6	4	Stereo/Mono -1 - On
111	Failed	7	3	9	6	8	7	4	Mono -1 - On
112	Failed	7	3	9	6	8	9	4	Mono -1 - On
113	Failed	7	3	9	6	10	5	1	Stereo - Off
114	Failed	7	3	9	6	10	6	1	Stereo - Off
115	Failed	7	3	9	6	10	7	1	Stereo - Off
116	Failed	7	3	9	6	10	8	1	Stereo - On
117	Failed	7	3	7	6	10	10	1	Stereo - On
118	Failed	7	3	8	6	10	11	4	Stereo - On
119	Failed	7	3	1	6	10	11	4	Stereo - On (Emerg)
120	Failed	7	3	1/2	6	10	11	4	Stereo - On
121	Failed	7	3	8	6	11	11	4	Mono -1 - On
122	Failed	7	3	5	6	11	11	4	Mono -1 - On
123	Failed	7	3	9	6	11	11	4	Mono -1 - On
124	Failed	7	3	9	6	1	3	4	Stereo - Off
125	Failed	7	3	9	6	1	4	4	Stereo - Off
126	Failed	7	3	9	6	1	5	4	Stereo - On
127	Failed	7	3	9	6	2	6	4	Mono -1 - On
128	Failed	7	3	4	6	2	7	4	Mono -1 - On
129	Failed	7	3	9	6	4	10	4	Stereo - Off
130	Failed	7	3	9	6	4	11	4	Stereo - On
131	Failed	7	3	9	6	4	11	4	Stereo - On
132	Failed	7	3	9	6	4	11	4	Stereo - On

~~TOP SECRET~~



TABLE 3-1

133	2 for 152	7	3	8	6	4	11	4	Stereo - On
134	180 for 184 (OK)	7	3	1	6	4	11	4	Stereo - On (Emerg)
135	111 for 113 (OK)	7	3	2	6	8/10	11	4	Mono-1/Stereo - On
136	Failed	7	3	8	6	11	11	4	Mono -1 - On
137	Failed	7	3	7	6	11	11	4	Mono -1 - On
138	Failed	7	3	2	6	11	11	4	Mono -1 - On
139	Failed	7	3	9	6	11	11	4	Mono -1 - On
140	Failed	7	3	6	6	11	11	4	Mono -1 - On
141	Failed	7	3	6	6	1	11	4	Stereo - On
142	Failed	7	3	2	6	1	11	4	Stereo - On
143	Failed	7	3	2	6	2	11	4	Mono -1 - On
144	Failed	7	3	2	6	2	11	1	Mono -1 - Off

TOP SECRET

# PMU GAS CONSUMPTION

1618 JF23

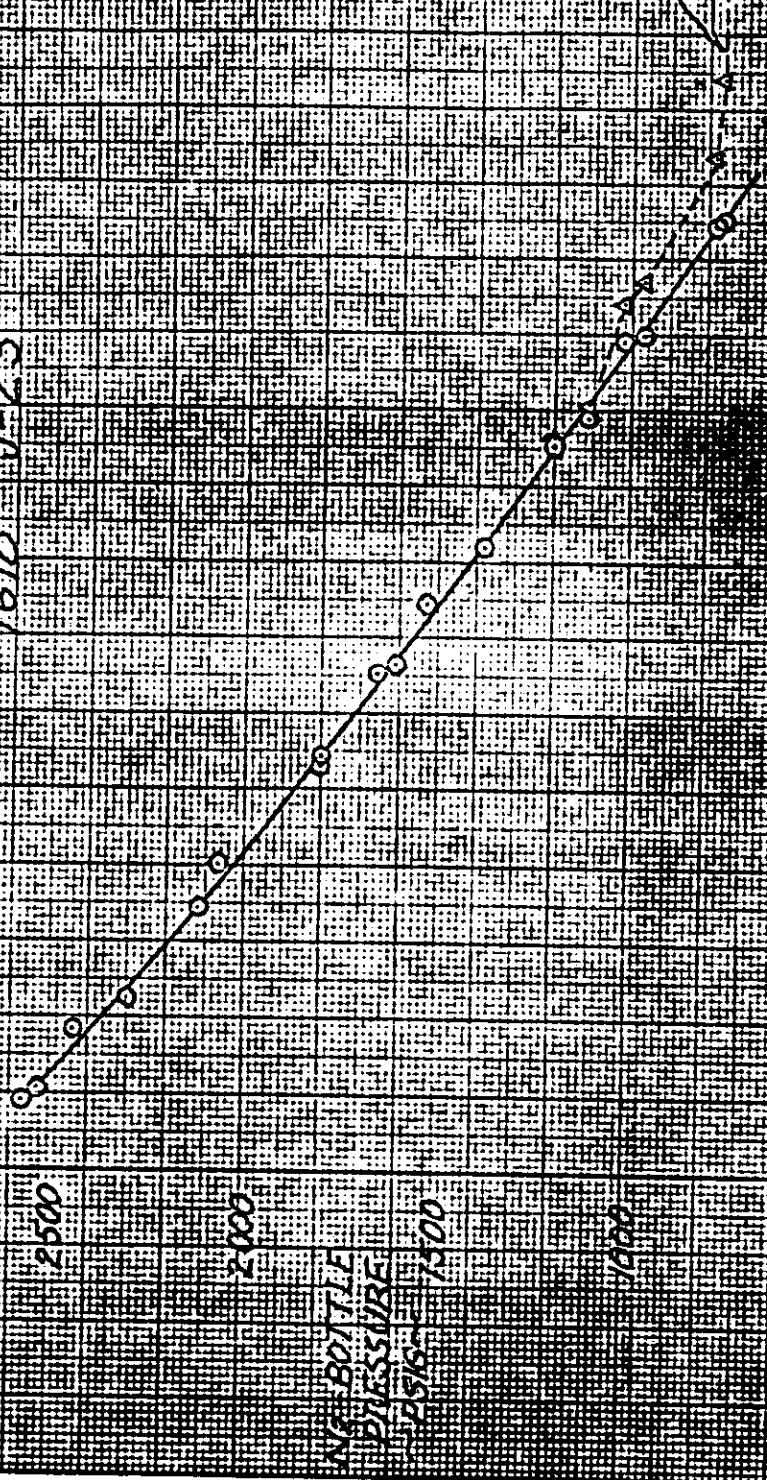

ADDITIONAL OPERATE TIME ON Y-AXIS ONLY

ACTUAL OPERATE TIME (MIN) - 300

TOP SECRET

~~TOP SECRET~~

On rev 133, the master camera completed 2 cycles of a 162 cycle programmed operation and on revs 134 and 135 operation was apparently normal with a total of 291 cycles completed for a programmed 297.

After the completion of Mission 1023-2 a vehicle deactivate was commanded and both the master and slave instruments operated normally. This operate signal came through the 30 sec. timer shown in Figure 3-1.

From the above it appears the most probable area of failure was in K13 in the command box or the cabling between the command box and J box and that the failure was intermittent in nature.

#### B. PANORAMIC CAMERA PERFORMANCE

The Master panoramic camera operated normally throughout Mission 1023-1, and until rev 102 in Mission 1023-2. Cut and wrap and switchover to Mission 1023-2 was normal. Cycle periods were as tabulated in Table 3-2. The 99/101% clutch ratios were normal and all start-up and shut-down and transport functions were normal on the engineering passes monitored.

The Slave panoramic camera operation was normal throughout both missions. The cycle periods were as tabulated in Table 3-2. The 99/101% clutch operation, start-up, shut-down and transport functions were normal. Cut and wrap and switch-over to Mission 1023-2 was normal.

#### C. STELLAR-INDEX PERFORMANCE

The Mission 1023-1 Stellar/Index camera operated normally on all engineering passes monitored. All metering and shutter open monitors were normal. The film supply was depleted prior to cut and wrap, however, the slew command was received and was normal.

The Mission 1023-2 Stellar/Index camera operated normally on all engineering operations until rev 102. Failure of the Master panoramic camera precluded operation after rev 102 except on revs 134 and 135.

#### D. CLOCK PERFORMANCE

Clock system performance was normal throughout both missions. Good clock correlation was obtained between system time and clock time. Table 3-3 is a tabulation of the correlation data for the flight.

~~TOP SECRET~~

TABLE 3-2

J-23/1618 MISSION 1023 CYCLE RATE DATA-ENGINEERING OPERATIONS

REV/MODE	RAMP	T.U.R.	INST 170			INST 171			170/171 DIFF.	
			ACT.	NOM.	DEV.	ACT.	NOM.	DEV.		
9	A	7 3	235	4.730	4.692	-0.81	4.750	4.701	-1.05	0.42
16	A	7 3	1685	2.260	2.216	-2.00	2.277	2.209	-3.09	0.75
25	A	7 3	262	4.696	4.658	-0.81	4.724	4.666	-1.23	0.60
31	A	7 3	1806	2.252	2.208	-1.97	2.249	2.204	-2.06	-0.13
41	A	7 3	285	4.675	4.627	-1.04	4.700	4.635	-1.41	0.53
47	A	7 3	1752	2.260	2.211	-2.21	2.262	2.205	-2.56	0.09
63	A	7 3	1795	2.255	2.209	-2.09	2.255	2.204	-2.32	-0.
88	B	7 3	357	4.603	4.514	-1.98	4.635	4.520	-2.54	0.70
94	B	7 3	1891	2.254	2.206	-2.17	2.261	2.202	-2.69	0.31
104	B	7 3	380				4.580	4.479	-2.25	
110	B	7 3	1840				2.264	2.203	-2.79	
120	B	7 3	409				4.520	4.426	-2.14	
126	B	7 3	1872				2.237	2.202	-1.59	

DEV. AND DIFF. ARE IN PERCENT  
 THE (-) SIGN INDICATES THAT THE INST IS SLOWER THAN  
 PREDICTED OR THAT INST 1 IS SLOWER THAN INST 2

CLOCK SUMMARY

ORDER FIT 1

SYS TIME I/P	CL TIME I/P	COMP SYS TM	DELTA ST	REV	STA
76032.767	360218.48990	76032.77870	-0.01072	0	1
36809.092	407394.83190	36809.10290	-0.00998	9	1
76245.938	446831.69190	76245.94810	-0.00915	16	1
37207.597	494193.36090	37207.59930	-0.00134	25	1
71305.082	528290.85590	71305.08150	0.00148	31	1
37483.229	43998.10890	37483.22670	0.00325	41	1
71575.172	78090.05990	71575.16490	0.00807	47	1
37937.257	130852.16790	37937.25300	0.00491	57	1
72012.622	164927.54290	72012.61520	0.00772	63	1
32845.257	212160.19690	32845.25150	0.00648	72	1
72161.855	251476.80790	72161.84770	0.00826	79	1
72161.855	251476.80790	72161.84770	0.00826	79	1
33156.062	298871.03490	33156.05690	0.00608	88	1
67122.004	332836.98690	67121.99610	0.00886	94	1
33447.445	385562.45990	33447.44930	-0.00332	104	1
67402.155	419517.17990	67402.15650	-0.00055	110	1
33714.282	472229.33190	33714.28870	-0.00573	120	1
67755.252	506270.31490	67755.25890	-0.00593	126	1
28343.017	16387.18090	28343.01920	-0.00126	135	1
67891.042	55935.23490	67891.05830	-0.01539	142	1

A0=-0.28418557580 06 A1= 0.9999996239850 00

SIGMA=0.00715 NO. POINTS= 20

RATIO OF CLOCK TIME TO SYS TIME= 0.1000000376010 01

ORDER FIT 2

SYS TIME I/P	CL TIME I/P	COMP SYS TM	DELTA ST	REV	STA
76032.767	360218.48990	76032.76550	0.00247	0	1
36809.092	407394.83190	36809.09440	-0.00146	9	1
76245.938	446831.69190	76245.94300	-0.00406	16	1
37207.597	494193.36090	37207.59780	0.00018	25	1
71305.082	528290.85590	71305.08210	0.00082	31	1
37483.229	43998.10890	37483.23010	-0.00016	41	1
71575.172	78090.05990	71575.16970	0.00328	47	1
37937.257	130852.16790	37937.25930	-0.00139	57	1
72012.622	164927.54290	72012.62210	0.00066	63	1
32845.257	212160.19690	32845.25860	-0.00064	72	1
72161.855	251476.80790	72161.85460	0.00139	79	1
72161.855	251476.80790	72161.85460	0.00139	79	1
33156.062	298871.03490	33156.06290	0.00007	88	1
67122.004	332836.98690	67122.00110	0.00384	94	1
33447.445	385562.45990	33447.45210	-0.00617	104	1
67402.155	419517.17990	67402.15760	-0.00160	110	1
33714.282	472229.33190	33714.28630	-0.00336	120	1
67755.252	506270.31490	67755.25390	-0.00095	126	1
28343.017	16387.18090	28343.01010	0.00784	135	1
67891.042	55935.23490	67891.04530	-0.00235	142	1

A0=-0.28418564470 06 A1= 0.9999998279120 00

A2=-0.13674287135010-12

SIGMA=0.00291 NO. POINTS= 20

TABLE 3-3

~~TOP SECRET~~

~~TOP SECRET~~ [REDACTED]

#### E. PRESSURE MAKE-UP SYSTEM PERFORMANCE

The pressure make-up system performed normally throughout both missions. Figure 3-2 is a plot of the PMU pressure versus operate time in minutes. The solid line indicates the stereo operate time. The dash lines include the mono No. 1 operate time.

#### F. TEMPERATURE ENVIRONMENT

Temperature data for the [REDACTED] acquisitions are included in Tables 3-4 and 3-5. Actual versus predicted data for major components are plotted on Figures 3-3, 3-4, and 3-5.

~~TOP SECRET~~ [REDACTED]

TABLE 3-4

J-23 TEMPERATURE SUMMARY

<u>SENSOR</u>	<u>ORBITS ACQUIRED</u>																			
<u>Master Camera</u>	<u>0</u>	<u>9</u>	<u>16</u>	<u>25</u>	<u>31</u>	<u>41</u>	<u>47</u>	<u>57</u>	<u>63</u>	<u>72</u>	<u>79</u>	<u>88</u>	<u>94</u>	<u>104</u>	<u>110</u>	<u>120</u>	<u>126</u>	<u>135</u>	<u>142</u>	
3	68	74	67	70	66	68	66	68	62	68	64	66	61	66	63	67	65	71	68	
4	68	77	68	72	68	72	67	69	64	70	64	68	63	68	63	68	65	73	68	
5	68	82	76	78	73	77	72	75	70	74	69	71	66	70	66	70	66	74	70	
6	62	81	74	76	72	74	71	72	69	71	67	68	64	65	63	64	63	67	65	
7	62	79	73	73	70	73	70	80	68	70	67	67	64	65	63	65	64	69	66	
8	66	79	72	75	70	74	69	72	67	71	66	69	64	68	64	68	64	72	67	
9	65	81	74	77	72	75	70	73	68	67	67	69	65	68	64	68	65	70	67	
10	-	-	-	-	-	-	-	-	-	-	-	-	-	-	-	-	-	-	-	
11	71	76	71	71	66	70	65	67	65	67	63	63	59	63	60	63	61	65	62	
12	70	76	69	73	67	72	66	71	65	71	65	70	64	69	64	71	66	76	70	
* 13	48	63	58	58	54	55	53	54	51	52	50	50	47	48	47	48	48	50	49	
AVG	68	78	70	74	69	73	68	72	67	70	66	68	63	67	63	67	64	71	68	
<u>Slave Camera</u>	3	63	72	68	68	64	66	62	63	59	62	57	57	54	55	52	54	52	55	54
4	64	72	66	69	63	67	62	66	59	59	58	60	56	58	54	57	54	59	56	
5	62	76	69	72	68	71	67	70	65	69	64	65	61	64	61	64	61	67	64	
6	61	74	69	71	67	69	66	69	65	70	65	65	62	64	62	65	64	69	62	
7	61	74	70	71	68	69	67	68	65	67	64	64	61	62	60	62	61	66	63	
8	63	73	68	70	66	69	64	68	62	68	59	64	59	63	59	63	60	66	62	
9	63	73	67	71	65	70	65	69	64	68	65	66	62	65	62	67	64	70	66	
10	-	-	-	-	-	-	-	-	-	-	-	-	-	-	-	-	-	-	-	
11	70	69	66	67	64	65	63	65	61	65	61	61	57	60	58	61	59	64	61	
12	63	71	65	68	62	66	62	64	59	63	58	60	54	57	53	56	53	59	55	
13	59	68	65	66	63	64	62	63	60	61	60	58	56	57	56	57	56	60	58	
AVG	63	72	67	69	65	68	64	67	62	65	61	62	58	60	58	61	57	64	60	
<u>Supply Spool</u>	1	64	64	61	63	60	62	61	62	59	61	59	58	55	56	55	57	55	60	59
2	68	70	65	67	63	66	63	65	61	64	60	60	57	59	56	59	56	61	59	

Note: Master camera sensor #13 functioned improperly and is not included in average.

TABLE 3-5

J-23 TEMPERATURE SUMMARY

<u>SENSOR</u>	<u>ORBITS ACQUIRED</u>																		
<u>Fair ("A")</u> <u>Barrel #1 ("B")</u>	<u>0</u>	<u>9</u>	<u>16</u>	<u>25</u>	<u>31</u>	<u>41</u>	<u>47</u>	<u>57</u>	<u>63</u>	<u>72</u>	<u>79</u>	<u>88</u>	<u>94</u>	<u>104</u>	<u>110</u>	<u>120</u>	<u>126</u>	<u>135</u>	<u>142</u>
1	235	36	62	34	67	34	59	34	62	34	45	26	43	29	43	29	51	35	51
2	230	23	20	17	20	23	20	20	23	23	20	59	77	62	88	68	106	74	109
3	227	13	24	11	27	13	24	13	22	13	22	61	113	61	110	63	119	63	107
4	230	49	52	44	49	44	49	44	46	41	47	26	44	23	38	23	38	26	29
5	230	25	53	48	48	48	50	42	42	42	45	22	28	22	31	19	28	22	28
6	225	55	73	49	70	49	60	44	55	44	44	26	43	28	43	28	43	-	-
<u>Barrel #2</u>																			
1	150	45	52	39	47	39	47	34	37	34	37	23	31	23	29	21	29	20	26
2	145	40	77	34	72	34	64	32	56	32	43	23	37	23	32	20	32	20	26
3	227	59	121	59	126	62	115	59	120	62	101	59	103	59	103	62	112	64	101
4	226	58	63	58	68	58	68	63	73	65	73	60	75	63	83	68	95	75	100
5	210	54	64	54	62	54	62	54	61	54	62	43	53	46	56	48	62	54	62
<u>Conic Adapter</u>																			
1	149	38	41	36	36	33	36	30	28	28	28	17	16	17	17	14	14	14	17
<u>Clock</u>																			
1	91	65	64	65	64	65	62	62	62	62	60	57	55	55	55	57	55	59	57
2	90	64	62	62	61	64	62	62	59	61	59	56	52	56	54	56	54	56	57
<u>Thrust Cone "A" to "B" SRV</u>																			
1	115	40	34	34	31	34	33	34	31	33	31	55	53	55	53	55	55	60	57
2	74	34	48	48	43	45	42	44	40	43	40	59	56	57	56	57	56	62	58
<u>Stellar/Index "A" to "B"</u>																			
1	79	54	51	51	44	44	48	44	44	44	44	38	38	34	38	34	34	41	37
2	66	53	47	50	40	44	44	48	41	44	41	43	35	39	35	39	39	47	39
<u>Recovery Battery "B" SRV</u>																			
1	73	69	64	62	61	60	61	60	57	57	57	81	79	85	84	91	91	85	80
<u>Master Cassette "A" SRV</u>																			
2	92	71	66	66	65	66	65	66	64	64	65	-	-	-	-	-	-	-	-

~~TOP SECRET~~



TOP SHEET

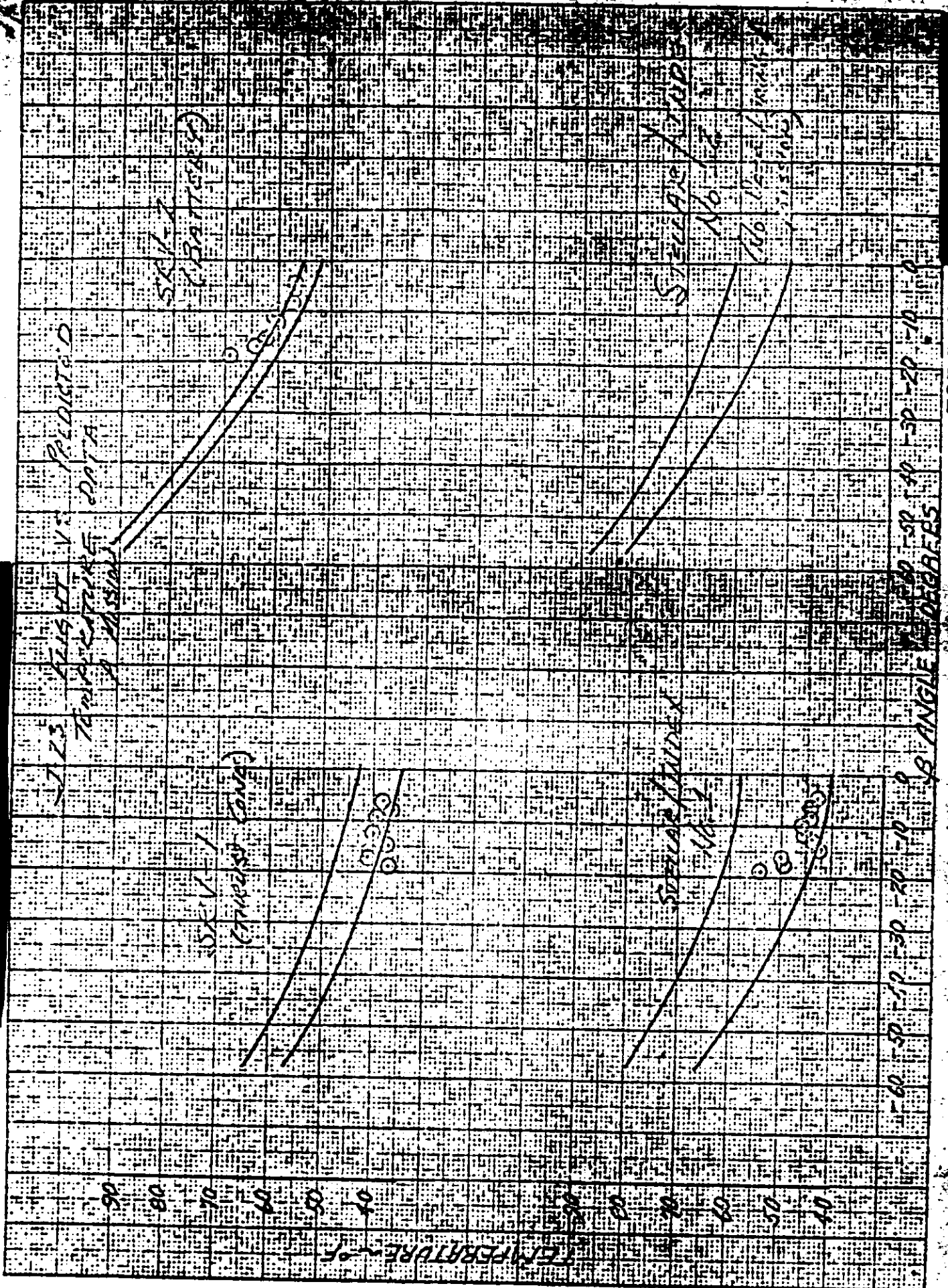

TOP SHEET

FIGURE 3

TOP SECRET

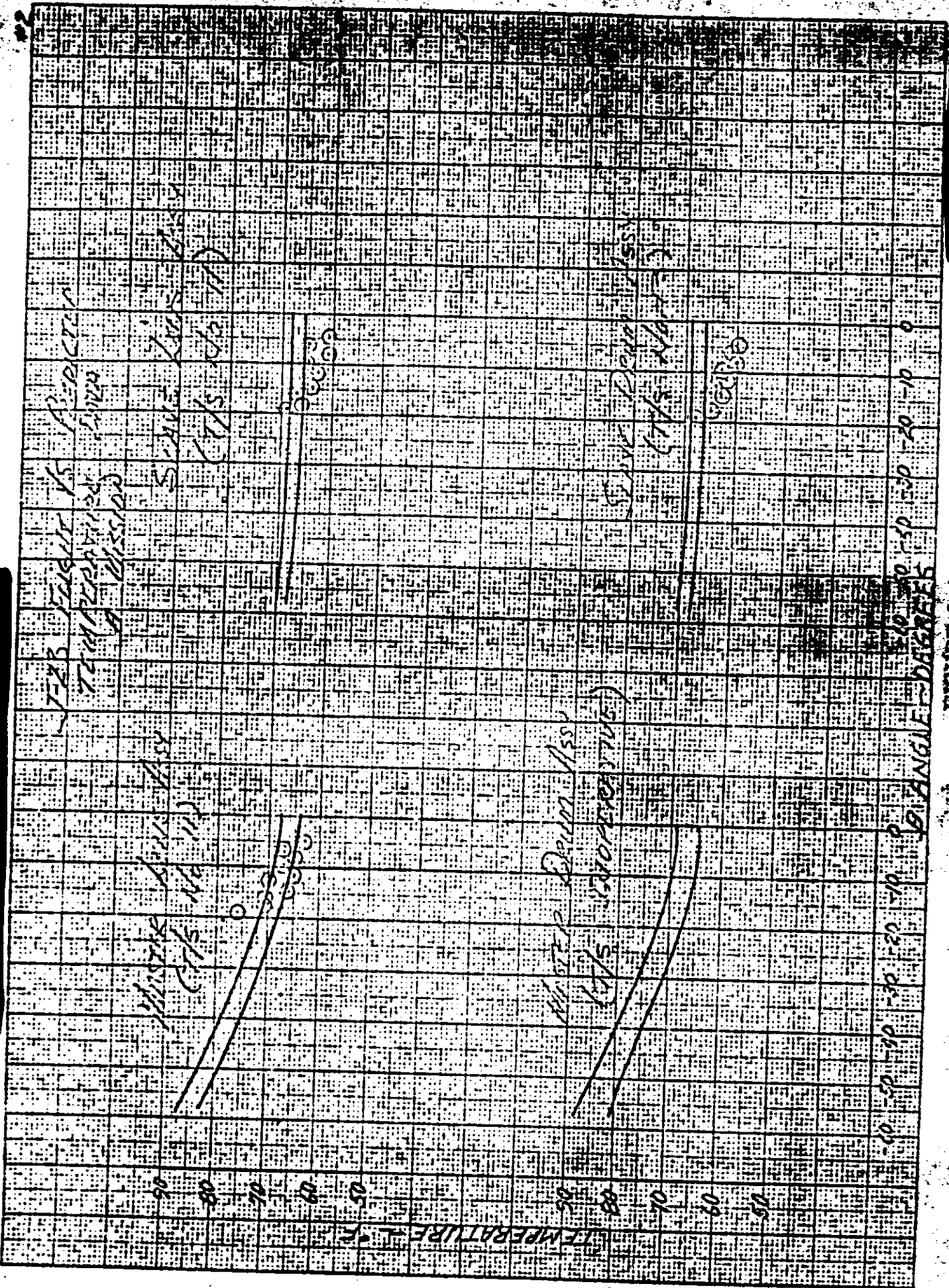
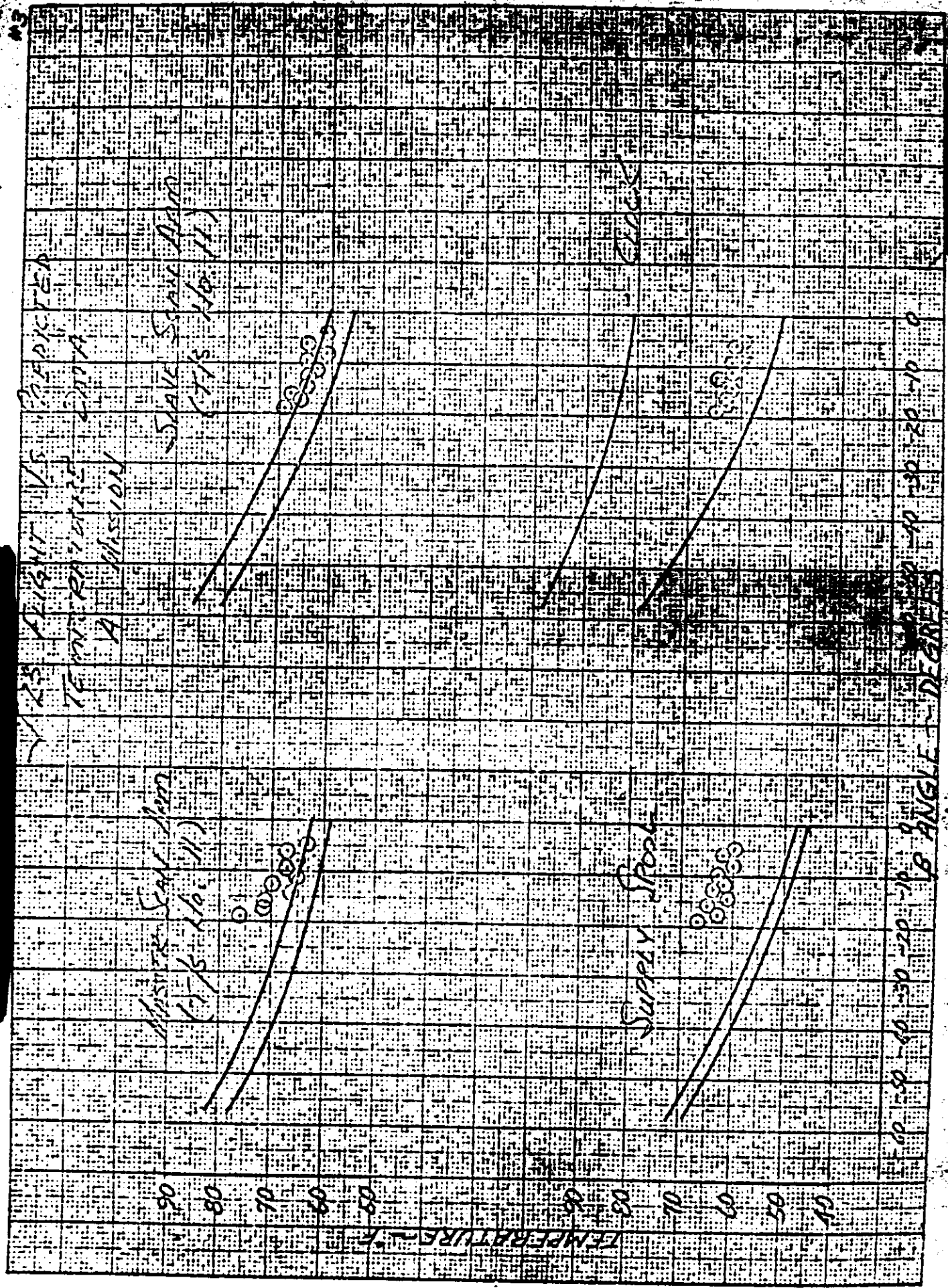

FIGURE 3-4

TOP SECRET

TOP SECRET



TOP SECRET

FIGURE 3-5

~~TOP SECRET~~ [REDACTED]

#### SECTION 4

### MISSION 1023-1 RECOVERY SYSTEM

SRV # 621 was received at A/P on 21 March 1963. The receiving weight was 149.2 pounds. After modifications and incorporation of outstanding E.O. 's, the SRV was delivered to systems test for incorporation into the J-23 system.

The capsule was delivered for shipment to VAFB on 5 May 1965.

The Mission 1023-1 recovery system was successfully recovered by air catch on rev 81. All re-entry sequence events monitored were normal and occurred within tolerance. The re-entry sequence of events is contained in Table 4-1. Impact was at 22.55 Deg. N., 166.16 W. The predicted impact point was 23.00 N, 167.64 W. The condition of the recovered capsule was satisfactory with no damage other than normal paint blistering due to the re-entry environment.

~~TOP SECRET~~ [REDACTED]

MISSION 1023-1

RECOVERY SEQUENCE OF EVENTS

<u>Event</u>	<u>System Time</u>	<u>Delta Time</u>	
		<u>Actual</u>	<u>Nominal</u>
Transfer	82803.72	-	-
Electrical Disconnect	82804.72	1.00	.900 <sup>+</sup> .43 - .40
* Separation	T/M Noise	-	2.0 <u>±</u> .25
** Spin	82808.13	3.41	3.4 <u>±</u> .30
Retro	82815.63	7.50	7.55 <u>±</u> .45
Despin	82826.24	10.61	10.75 <u>±</u> .54
T/C Separation	82827.80	1.56	1.5 <u>±</u> .15
Voltage Mon. Closed	82904.25	175.38	180.0 <u>±</u> 42.0
"G" Switch Open	No Data	-	-
Parachute Cover Off	No Data	-	34.0 <u>±</u> 1.5
Drogue Chute Deployed	No Data	-	.75 <u>±</u> .08
Drogue Chute Release	No Data	-	10.05 <u>±</u> 1.0
Main Chute Deployed	No Data	-	.80 <u>±</u> .20
Main Chute Disreefed	No Data	-	4.0 <u>±</u> 1.7

\* From Transfer  
 \*\* From Elect. Disc.

Spin Rate - 66.7 RPM  
 Despin Rate - N/A  
 Retro Velocity - 956.8 Ft/Sec.

TABLE 4-1

~~TOP SECRET~~

SECTION 5

MISSION 1023-2 RECOVERY SYSTEM

SRV # 649 was received at A/P on 3 November 1963 at a receiving weight of 150 pounds. After modification and incorporation of outstanding E. O. 's the capsule was delivered to systems test for incorporation into the J-23 system.

The capsule was delivered for shipment to VAFB on 5 May 1965.

The Mission 1023-2 recovery system was successfully recovered by air catch on rev 144. All re-entry events monitored were normal and occurred within tolerance as listed in Table 5-1.

The predicted impact point was  $25^{\circ}41.9' N$ ,  $165^{\circ}26.3' W$  and the actual impact point was  $25^{\circ}49' N$ ,  $164^{\circ}36' W$ .

The condition of the recovered capsule was satisfactory with damage limited to normal paint blistering due to the re-entry environment.

~~TOP SECRET~~

MISSION 1023-2

RECOVERY SEQUENCE OF EVENTS

<u>Event</u>	<u>System Time</u>	<u>Delta Time</u>	
		<u>Actual</u>	<u>Nominal</u>
Transfer	78423.80	-	-
Electrical Disconnect	78424.86	1.06	.900 + .43 - .40
* Separation	78425.78	0.96	-
** Spin	78428.28	3.42	3.4 + .30
Retro	78436.06	7.78	7.55 + .45
Despin	78446.80	10.74	10.75 + .54
T/C Separation	78448.35	1.55	1.50 + .15
Voltage Mon. Closed	78526.15	177.30	180.0 + 42.0
"G" Switch Open	No Data	-	-
Parachute Cover Off	No Data	-	34.0 + 1.5
Drogue Chute Deployed	No Data	-	.75 + .08
Drogue Chute Release	No Data	-	10.05 + 1.0
Main Chute Deployed	No Data	-	.80 + .20
Main Chute Disreefed	No Data	-	4.0 + 1.7

\* From Transfer  
\*\* From Elect. Disc.

Spin Rate - N/A  
Despin Rate - 11.2 RPM  
Retro Velocity - 1112.0 Ft. /Sec.

TABLE 5-1

SECTION 8

MASTER PANORAMIC CAMERA

A. COMPONENT ASSIGNMENT

<u>Component</u>	<u>Serial Number</u>
Main Camera	170
Main Camera Lens	1592435
Supply Horizon Camera	178G10
Supply Horizon Camera Lens	814022
Take-up Horizon Camera	180G9
Take-up Horizon Camera Lens	813554
Supply Cassette	SC-31

B. CAMERA DATA AND FLIGHT SETTINGS

Main Camera:

Lens	24" f/3.5
Slit Width	0.225"
Filter Type	Wratten 25
Film Type	Eastman Type 3404

Supply (Port) Horizon Camera:

Lens	55 mm f/6.8
Aperture Setting	f/6.8
Exposure Time	1/100 second
Filter Type	Wratten 25

Take-up (Starboard) Horizon Camera:

Lens	55 mm f/6.8
Aperture Setting	f/8.0
Exposure Time	1/100 second
Filter Type	Wratten 25



### C. POST FLIGHT PERFORMANCE EVALUATION

The camera produced 2971 frames of photography during Mission 1023-1 and 1498 frames during Mission 1023-2. The overall photographic quality was considered somewhat lower than Mission 1022. Cloud cover was estimated to be 35% for both Mission 1023-1 and 1023-2. The evaluation team analyzed the photography for cloud and haze content. They concluded that the cloud coverage was approaching 50% and that significant atmospheric haze was present during the majority of both missions.

The photographic quality of the Master camera film was generally better than the Slave camera film however many areas were found where the photography was comparable. The photography was considered to be somewhat lower in quality and information content than recent missions. The duplicate positives appeared to contain more grain than normally observed and were denser than usual.

The slit-filter combination selected for the Master camera was to produce a slightly lower exposure condition than used in previous missions. Evaluation of the duplicate positive film showed no apparent loss in information content due to this selection. There were no observed areas which were underexposed however many areas were considered overexposed.

Fogged areas were present on the film near the beginning and end of most camera operations. The fogged areas were in the vicinity of the intermediate roller assembly, the supply cassette and the first recovery system. This latter fog pattern was not present during Mission 1023-2 however all other patterns were present throughout both missions.

The light leak normally encountered at the Master camera drum seal is the probable cause of the fog pattern near the intermediate roller assembly. Extensive analysis has shown that it is not possible to eliminate this light leak without significant camera redesign or extensive film chutes. The magnitude of this fogged area does not appear to warrant the modification of the system. The fog pattern near the supply cassette is attributed to the same drum light leak on the Slave camera.

The fog pattern near the forward recovery system is caused by light piped through the fiberglass strands in the ablative material. A film chute has been designed for the area between the water seal and the thrust cone. It will be incorporated on systems in the near future.

~~TOP SECRET~~

The binary data block, time track and horizon cameras operated properly throughout both missions. One horizon camera fiducial was somewhat bloomed. There were no observed areas containing banding or flared imagery.

The Master camera operations became intermittent during pass D-102 as noted in Section 3. The camera was programmed for 147 cycles during pass D-102 however only 34 frames were taken. Analysis of the binary time word showed that the 34 frames were at the end of the operate cycle and corresponded to the last 34 frames of the Slave camera. The same conditions prevailed during pass D-133 as the Master camera frames, two in all, corresponded with the last two Slave camera frames.

A small area of soft imagery appeared at the supply end of all formats during pass D-53. The soft area was present throughout the remainder of both missions becoming gradually smaller. The degree of softness was slight and could only be detected where fine detail imagery was present. The previously established correlation between soft focus and frame edge location determined by NPIC did not hold true for this mission.

A tapered streak of minus density, on the original negative, was present along the time track edge extending approximately five inches into the format from the take up end. This streak is apparently caused by the camera slit being somewhat short and vignetting the format at the extreme of the IMC motion. The resulting degradation was very minor.

~~TOP SECRET~~

SECTION 7

SLAVE PANORAMIC CAMERA

A. COMPONENT ASSIGNMENT

<u>Component</u>	<u>Serial Number</u>
Main Camera	171
Main Camera Lens	1512435
Supply Horizon Camera	182G10
Supply Horizon Camera Lens	812300
Take-up Horizon Camera	181G9
Take-up Horizon Camera Lens	N/A
Supply Cassette	SC-31

B. CAMERA DATA AND FLIGHT SETTINGS

Main Camera:

Lens	24" f/3.5
Slit Width	0.150"
Filter Type	Wratten 21
Film Type	Eastman Type 3404

Supply (Starboard) Horizon Camera:

Lens	55 mm f/6.8
Aperture Setting	f/8.0
Exposure Time	1/100 second
Filter Type	Wratten 25

**Take-up (Port) Horizon Camera:**

Lens	55 mm f/6.8
Aperture Setting	f/6.8
Exposure Time	1/100 second
Filter Type	Wratten 25

**C. POST FLIGHT PERFORMANCE EVALUATION**

The camera produced 2966 frames during Mission 1023-1 and 2956 during Mission 1023-2. The general photographic quality was considered to be somewhat inferior to the Master camera, however as noted in Section 6, many areas were found where the Slave camera photography was comparable and superior to the Master camera results.

The fog patterns on film correlate with the suspected areas of light leaks at the forward ablative shell and at the camera drums. The fog patterns were minor and caused no significant loss of information content.

The same exposure, density and grain anomalies were present on the Slave camera duplicate positives as were observed on the Master camera.

The time track, horizon cameras and fiducials, binary data block and end-of-pass mark all operated properly throughout both missions. The data block index lamp adjacent to the camera serial number was bloomed but caused no degradation to the time word lamps.

SECTION 8

PANORAMIC CAMERA EXPOSURE

The Master camera contained a 0.225 inch wide slit and a Wratten 25 filter while the Slave camera had a 0.150 inch wide slit and a Wratten 21 filter. These conditions placed nominal exposure on the full processing curve as published by [redacted] for 4404 emulsion. It was ascertained post flight that Type 3404 emulsion was used in both panoramic cameras however Eastman Kodak has stated that the change is in nomenclature only.

The illumination conditions during the mission were relatively constant as the flight was conducted during the summer. The frequency distributions of the solar elevations and solar azimuths encountered during the photographic operations are shown in Figures 8-1 to 8-4.

The nominal exposure times of the Master and Slave cameras are shown as a function of latitude for passes D-24, D-56, D-88 and D-120 in Figures 8-5 to 8-12. The predicted level of processing for the original negative is based on the in-flight performance estimate and is tabulated below with the processing levels reported by [redacted]

<u>Mission</u>	<u>Camera</u>		<u>Primary</u>	<u>Intermediate</u>	<u>Full</u>
1023-1	FWD	Predicted	0	5	95
		Reported	19	54	27
1023-1	AFT	Predicted	0	11	89
		Reported	0	39	61
1023-2	FWD	Predicted	0	7	93
		Reported	0	19	81
1023-2	AFT	Predicted	0	3	97
		Reported	0	34	66

The large percentage of primary and intermediate processing on the FWD camera film of Mission 1023-1 was noted by the evaluation team however,

~~TOP SECRET~~ [REDACTED]

as stated in Section 6, no areas of underexposure were observed. [REDACTED]  
[REDACTED] subsequently advised the contractors that a machine malfunction had produced the large quantity of primary and intermediate processing.

It is significant to note that in all cases more intermediate processing was reported than predicted. This is a departure from the previously experienced processing data as it has been normal that the reported levels have more full processing than predicted.

~~TOP SECRET~~ [REDACTED]

~~TOP SECRET~~

SOLAR ELEVATION FREQUENCY DISTRIBUTION

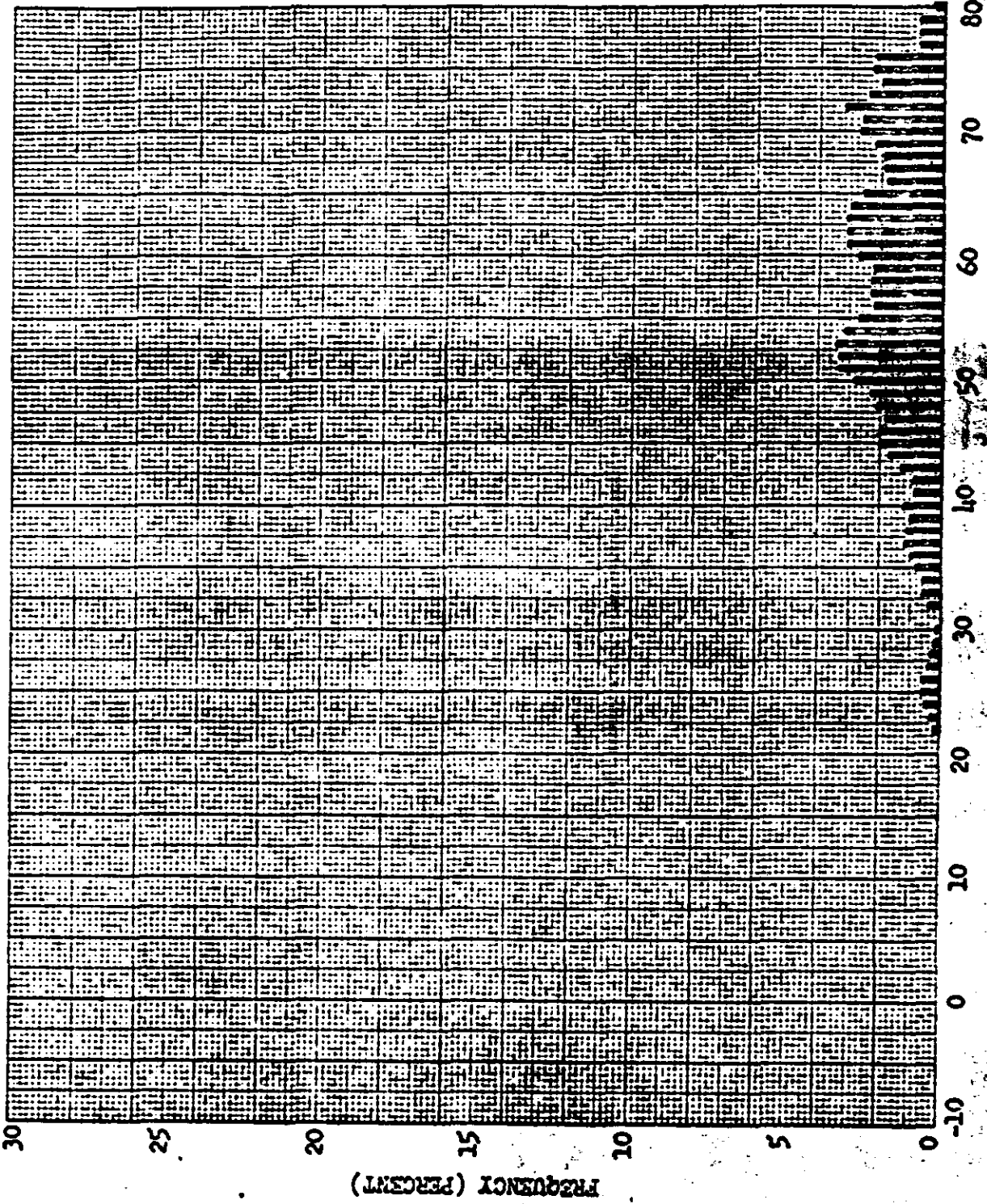

Mission No: 1023-1

Payload No: J-23

Camera No: 170

Launch Date: 8/17/65

Launch Time: 2100 Z

Inclination: 70°

SOLAR ELEVATION (DEGREES)

FIGURE 8-1

~~TOP SECRET~~

~~TOP SECRET~~

SOLAR AZIMUTH FREQUENCY DISTRIBUTION

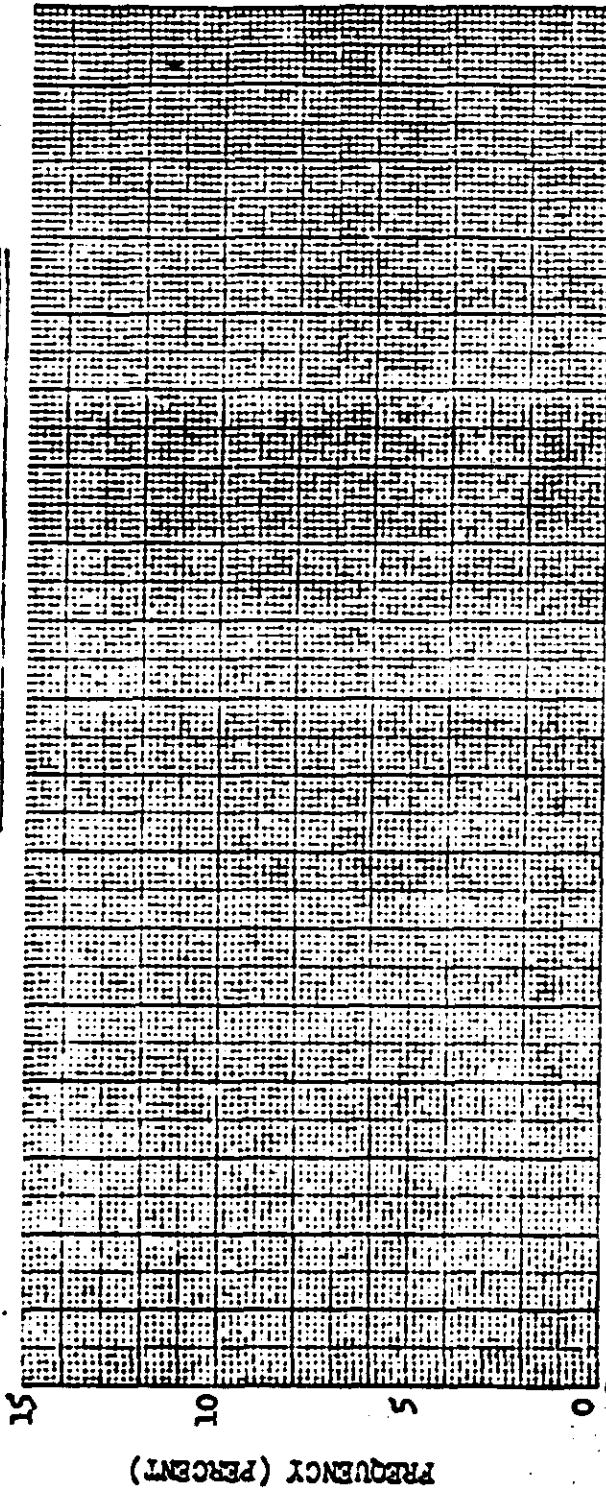

FREQUENCY (PERCENT)

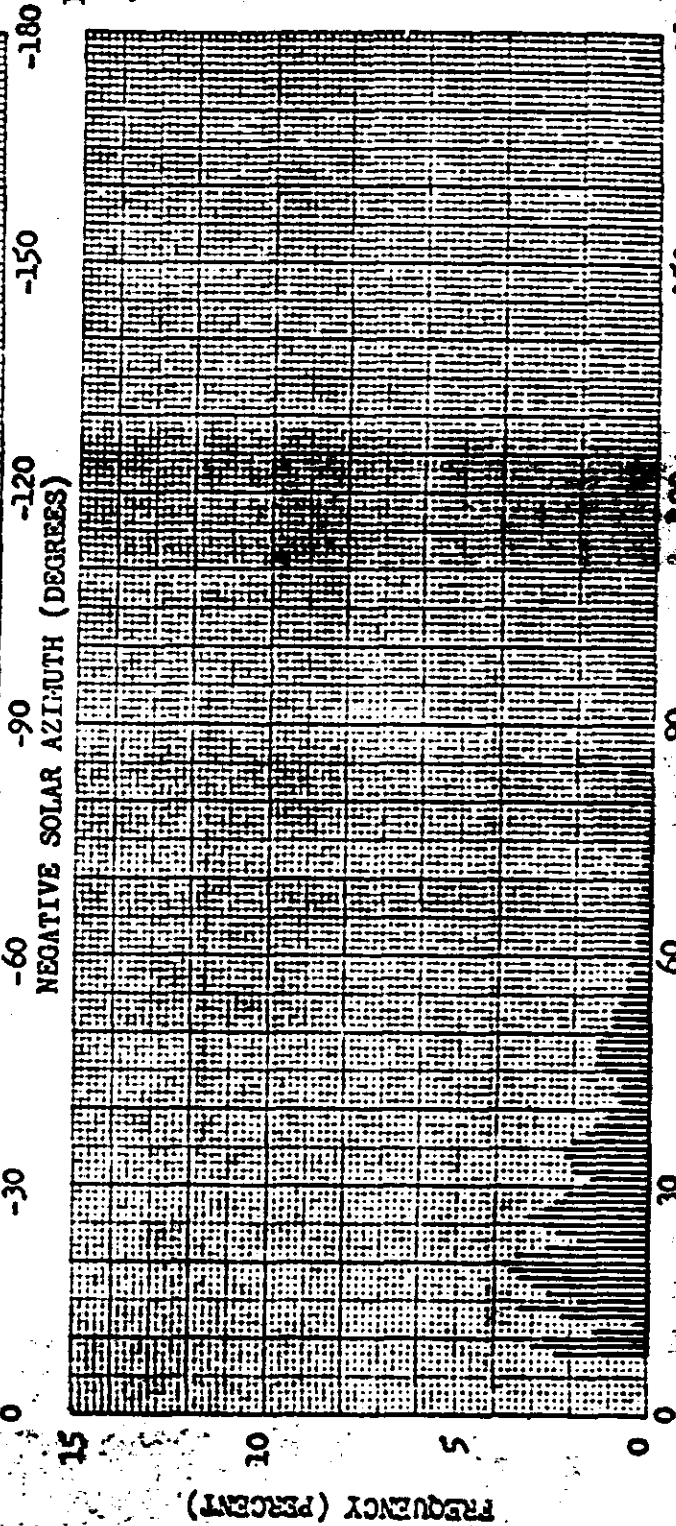

FREQUENCY (PERCENT)

Mission No: 1023-1

Payload No: J-23

Camera No: 170

Launch Date: 8/17/65

Launch Time: 2100 Z

Inclination: 70°

SIGN NOTATION



Direction Of Flight

150  
120  
90  
60  
30  
0  
POSITIVE SOLAR AZIMUTH (DEGREES)

150  
180  
NEGATIVE SOLAR AZIMUTH (DEGREES)

~~TOP SECRET~~



~~TOP SECRET~~

SOLAR ELEVATION FREQUENCY DISTRIBUTION

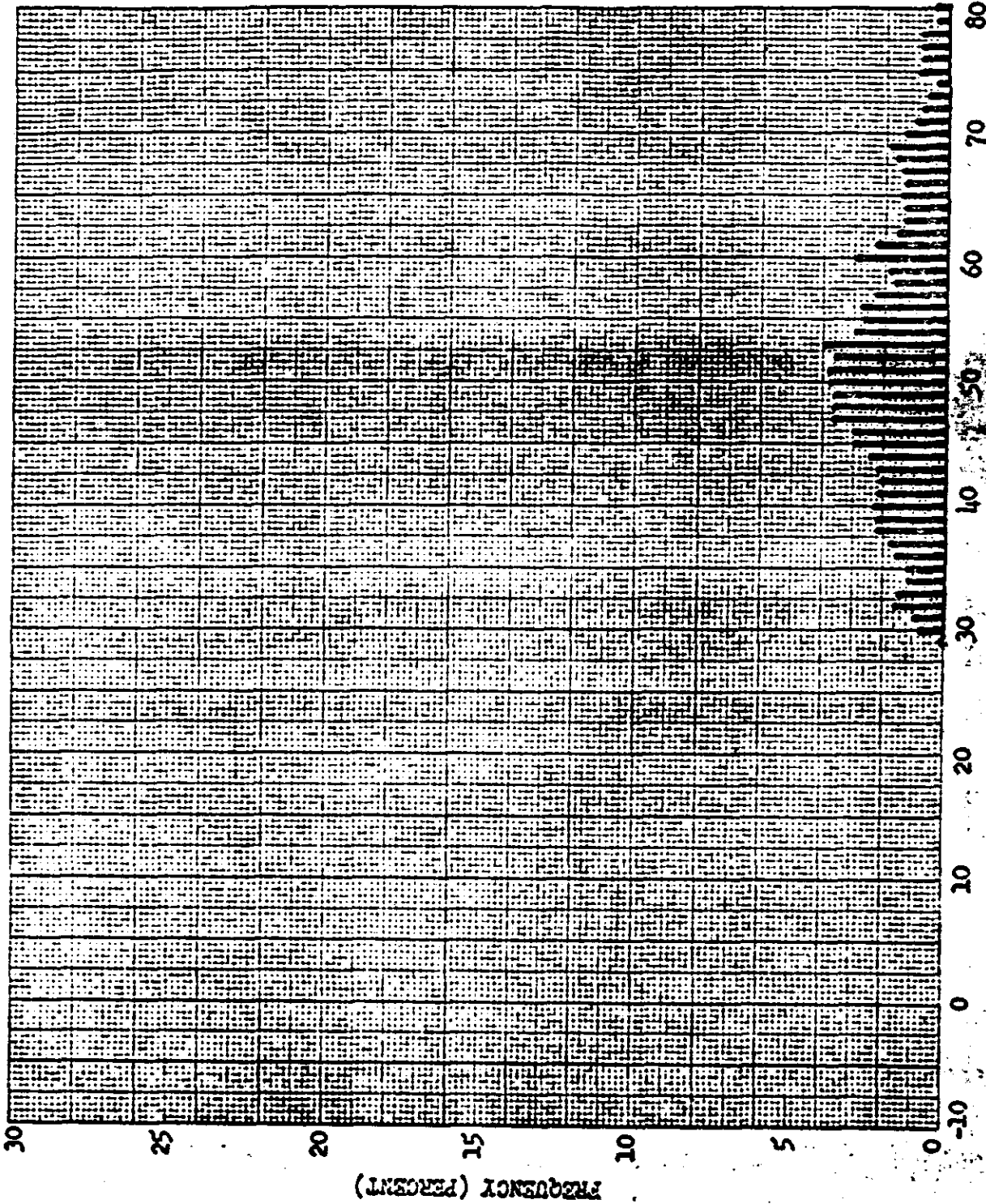

Mission No: 1023-2

Payload No: J-23

Camera No: 170

Launch Date: 8/17/65

Launch Time: 2100 Z

Inclination: 70°

SOLAR ELEVATION (DEGREES)

FIGURE 8-3

~~TOP SECRET~~

~~TOP SECRET~~

SOLAR AZIMUTH FREQUENCY DISTRIBUTION

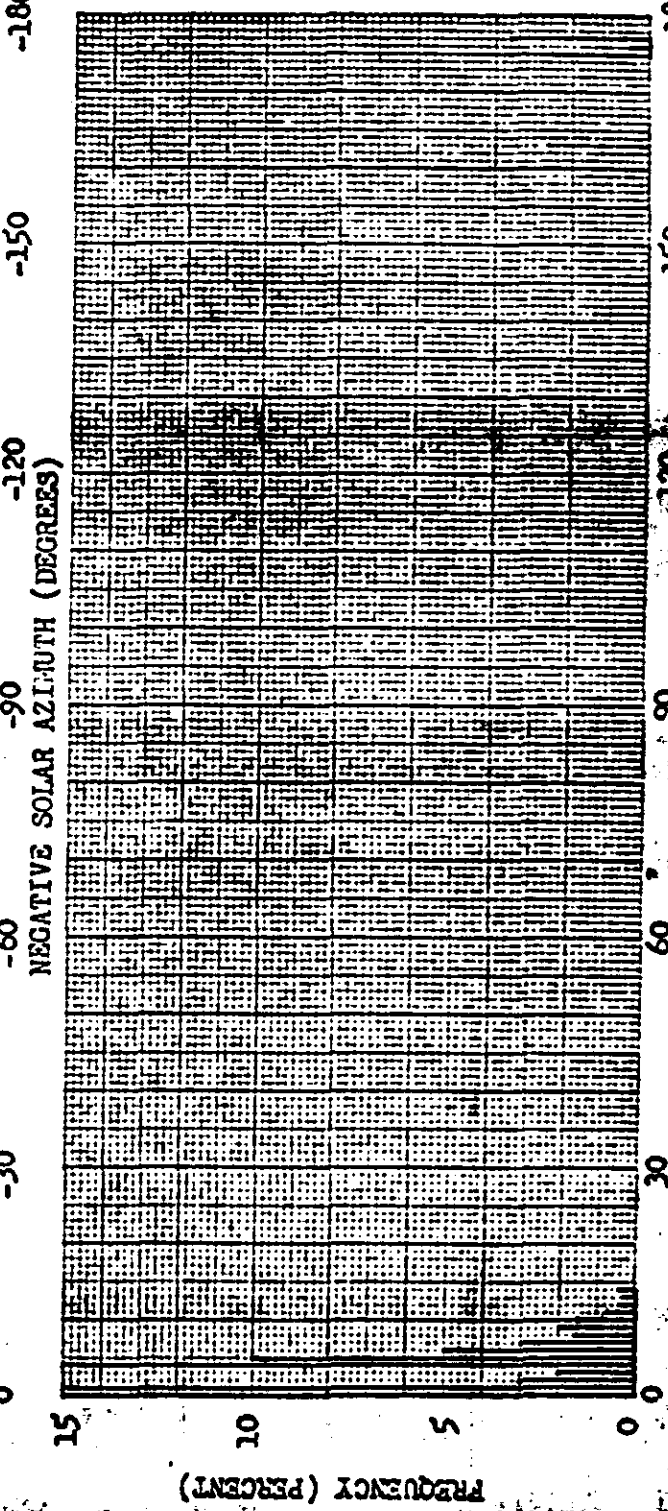
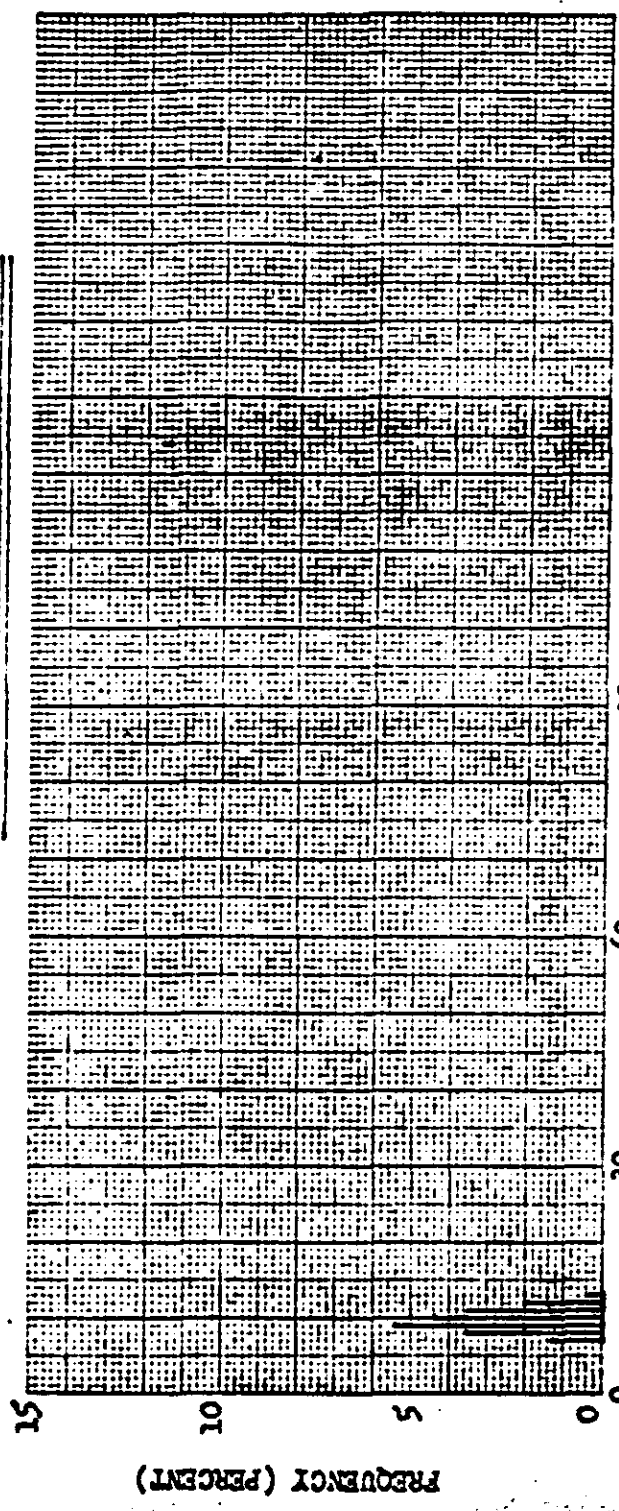

Mission No: 1023-2

Payload No: J-23

Camera No: 170

Launch Date: 8/17/65

Launch Time: 2100 Z

Inclination: 70°

SIGN NOTATION

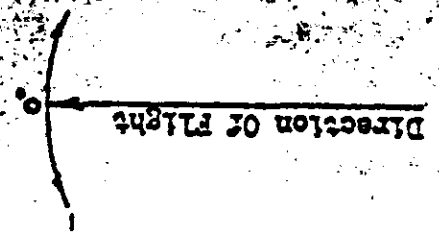

~~TOP SECRET~~

~~TOP SECRET~~

EXPOSURE POINTS

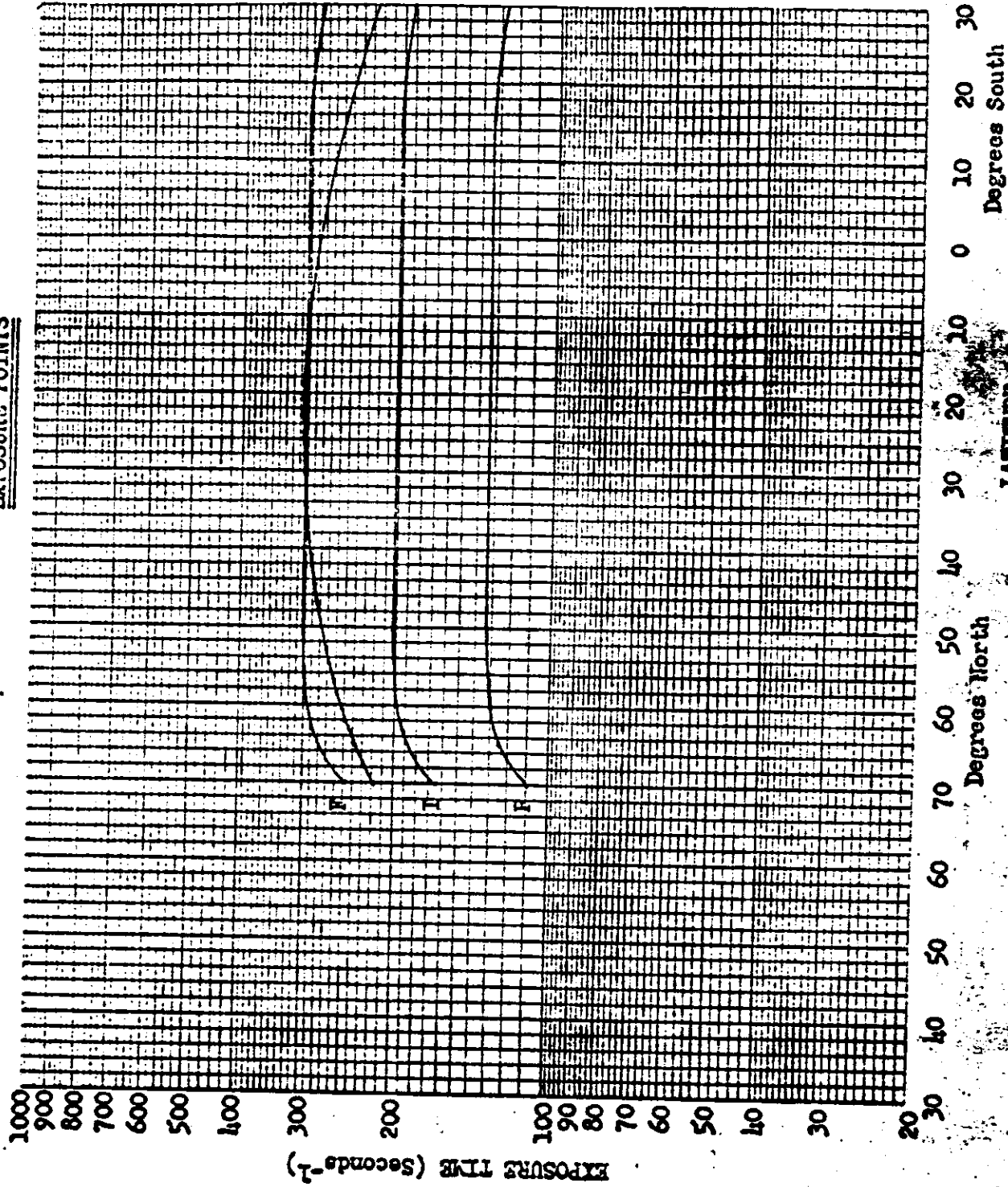

Mission No: 1023

Payload No: J-23

Camera No: 170

Pass No: 24

Launch Date: 8/17/65

Launch Time: 2100 Z

Slit Width: .225

Filter Type: Wratten 25

Film Type: 3404

LATITUDE  
FIGURE 8-5

~~TOP SECRET~~

~~TOP SECRET~~

EXPOSURE POINTS

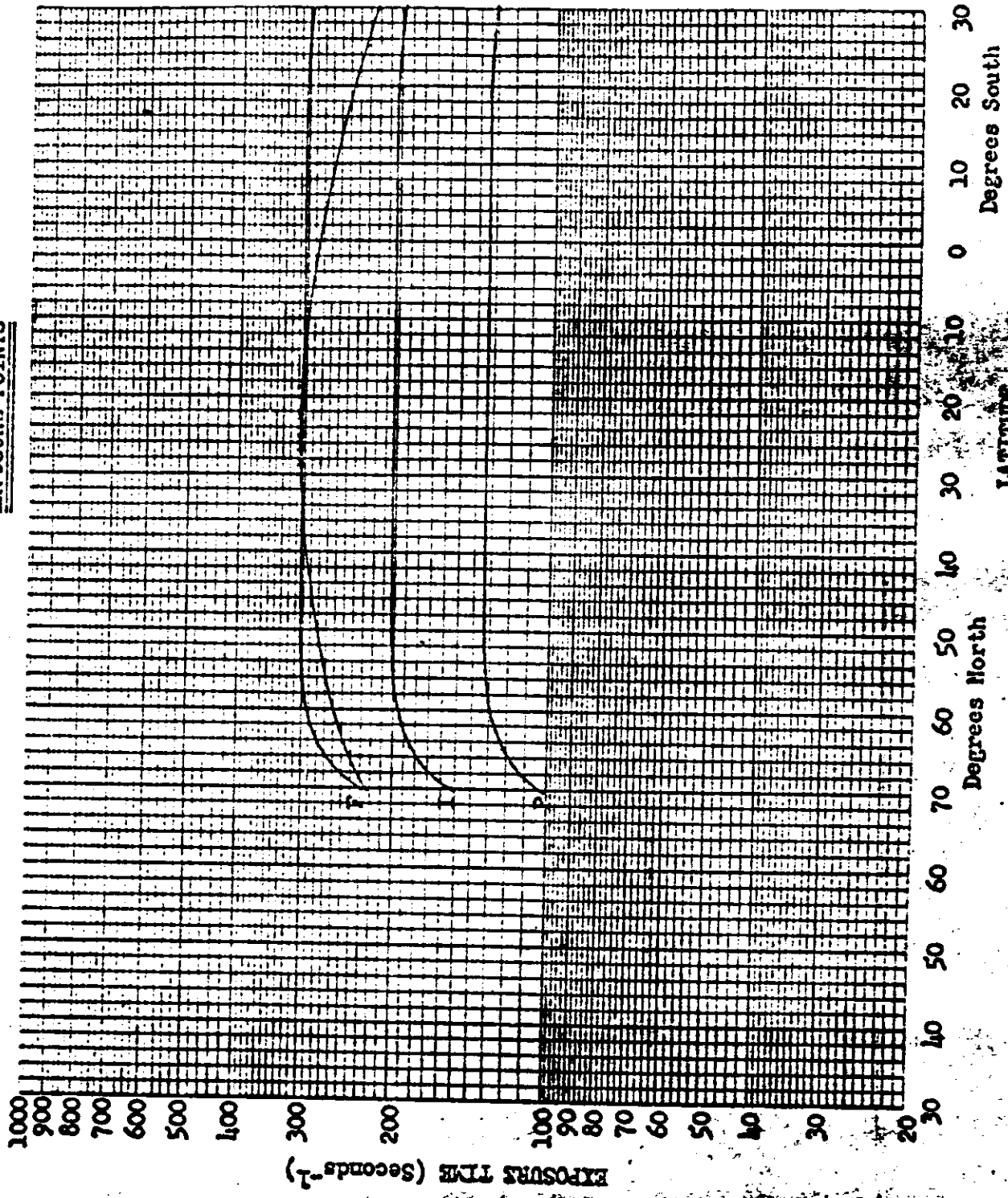

Mission No: 1023  
Payload No: J-23  
Camera No: 170  
Pass No: 56  
Launch Date: 8/17/65  
Launch Time: 2100 Z  
Slit Width: .225  
Filter Type: Wratten 25  
Film Type: 3104

FIGURE 8-6

~~TOP SECRET~~

~~TOP SECRET~~

EXPOSURE POINTS

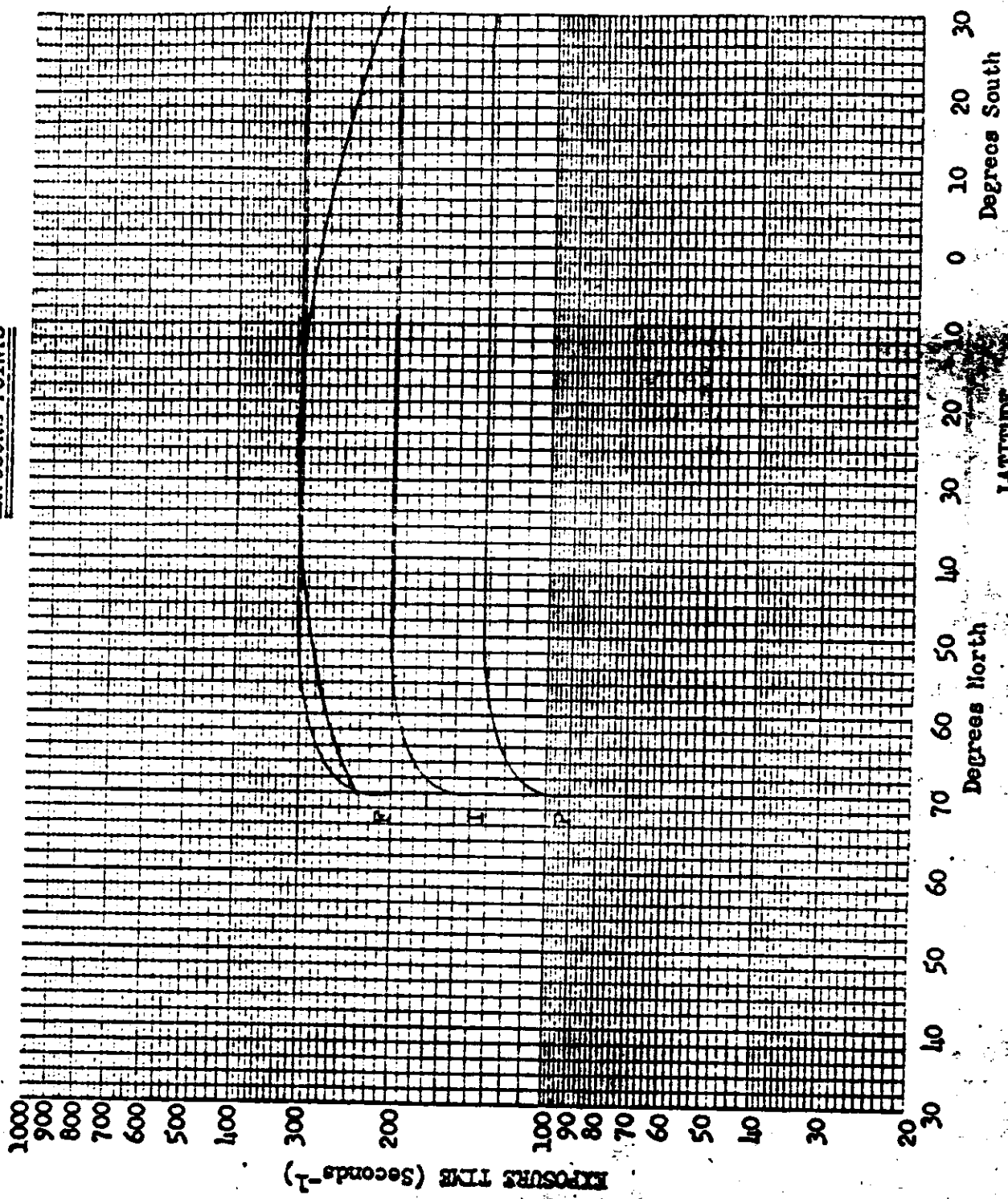

Mission No: 1023

Payload No: J-23

Camera No: 170

Pass No: 86

Launch Date: 8/17/65

Launch Time: 2100 Z

Slit Width: .225

Filter Type: Wratten 25

Film Type: 3104

LATITUDE  
FIGURE 8

~~TOP SECRET~~

~~TOP SECRET~~

EXPOSURE POINTS

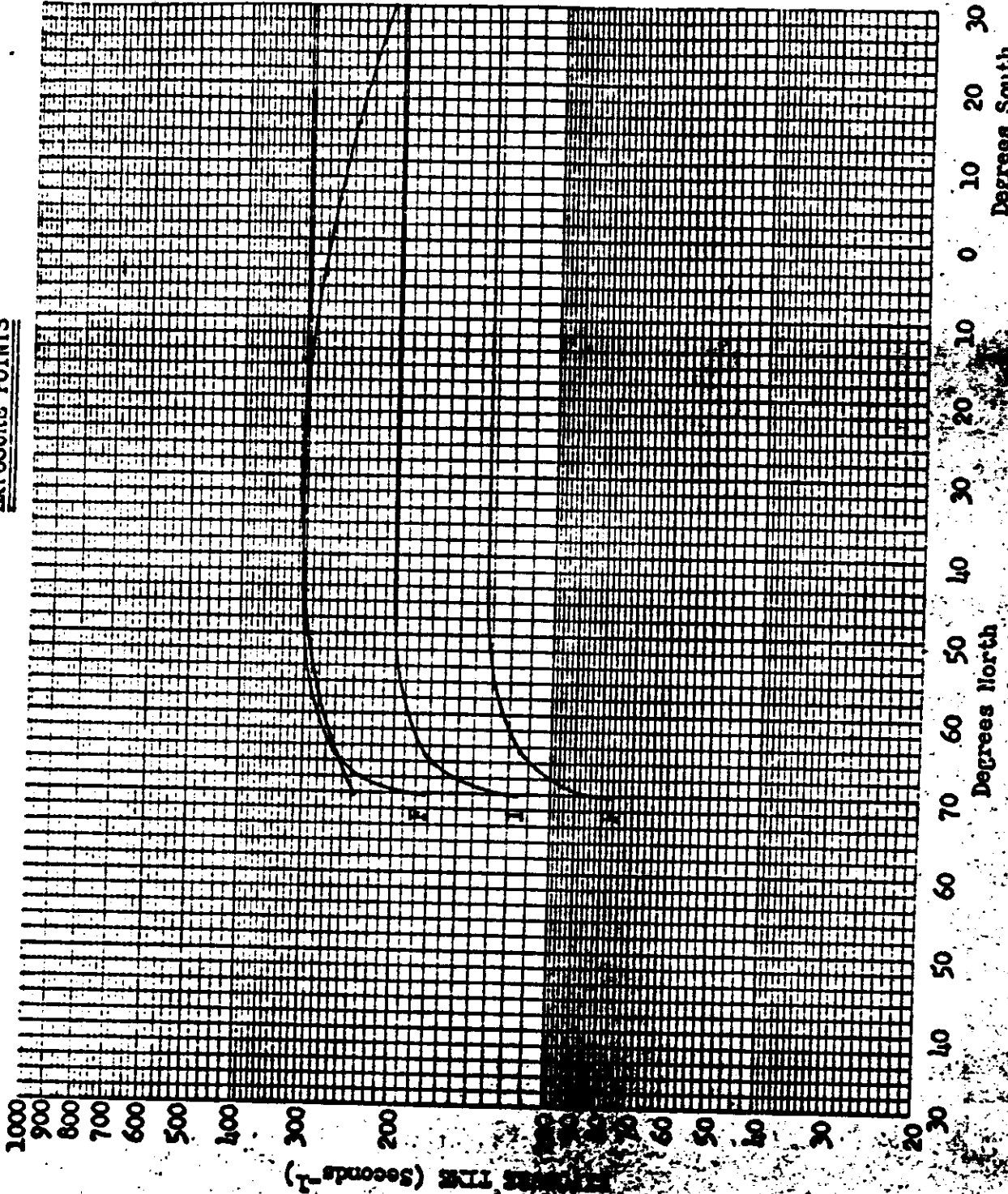

Mission No: 1023

Payload No: J-23

Camera No: 170

Pass No: 120

Launch Date: 8/17/65

Launch Time: 2100 Z

Slit Width: 0.225

Filter Type: Wratten 25

Film Type: 3404

~~TOP SECRET~~

FIGURE 9

~~TOP SECRET~~

EXPOSURE POINTS

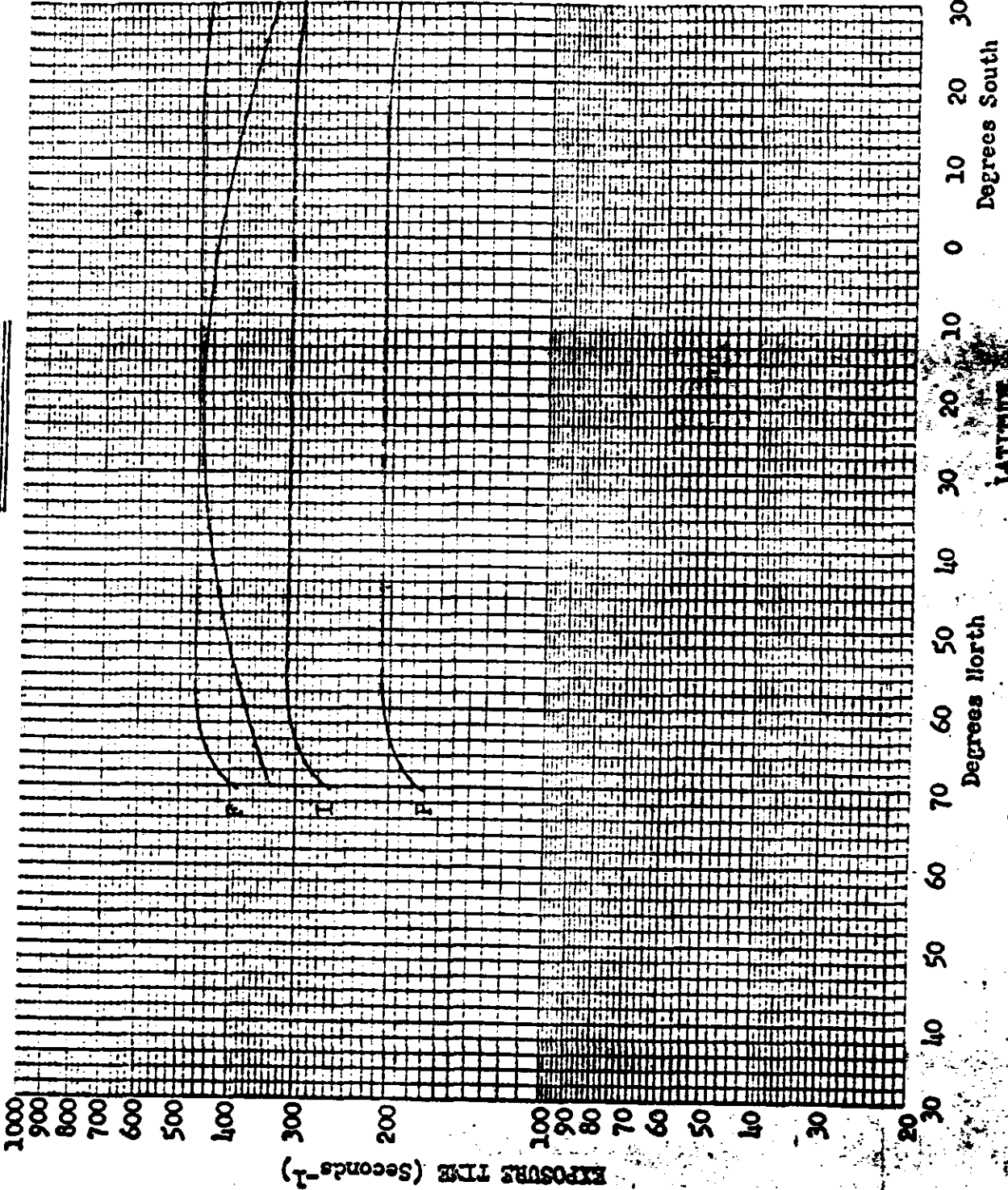

Mission No: 1023

Payload No: J-23

Camera No: 171

Pass No: 24

Launch Date: 8/17/65

Launch Time: 2100 Z

Slit Width: .150

Filter Type: Wratten 21

Film Type: 3404

LATITUDE

FIGURE 8-9

~~TOP SECRET~~

~~TOP SECRET~~

EXPOSURE POINTS

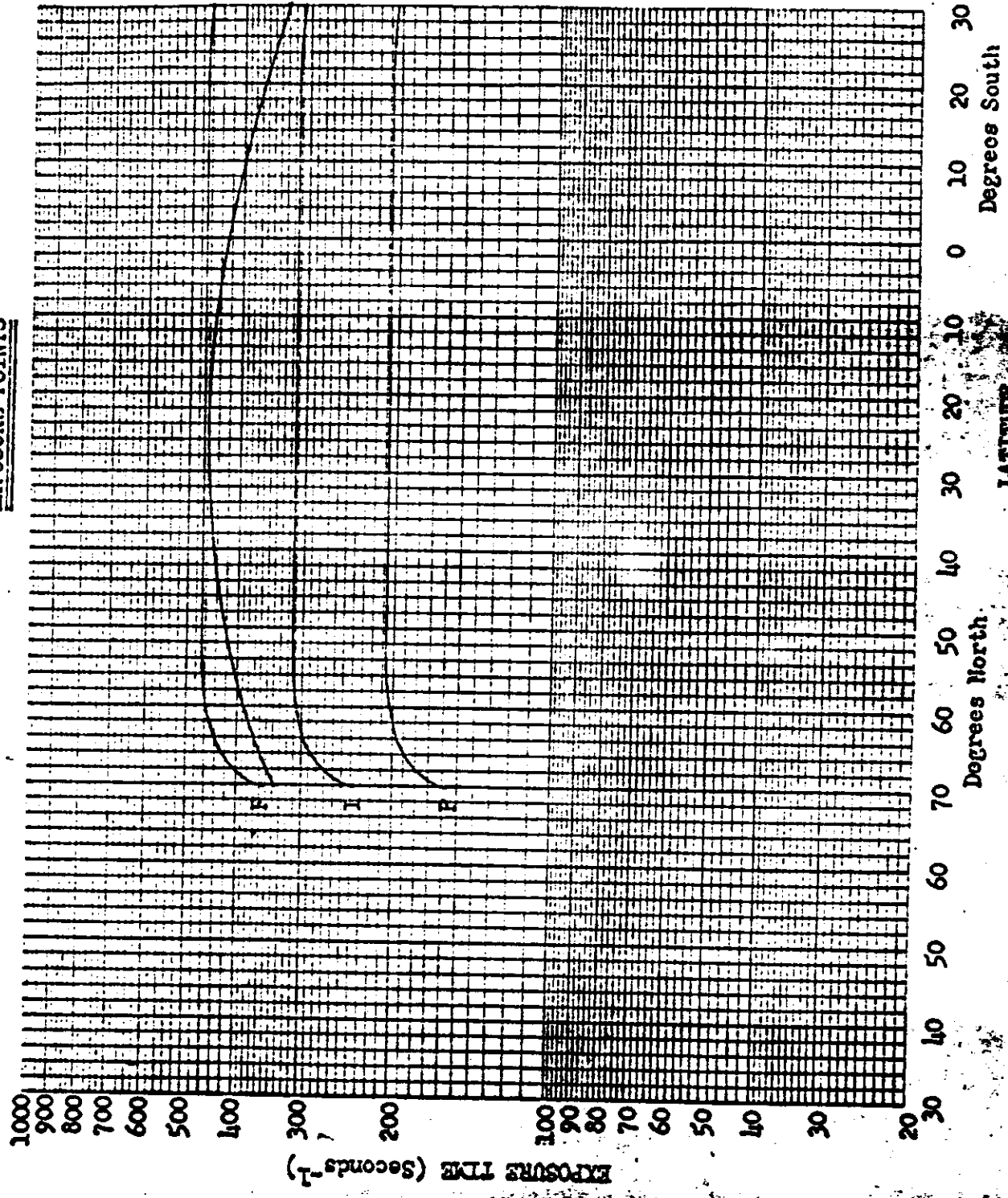

Mission No: 1023

Payload No: J-23

Camera No: 171

Pass No: 56

Launch Date: 8/17/65

Launch Time: 2100 Z

Slit Width: .150

Filter Type: Wratten 25

Film Type: 3404

LATITUDE  
FIGURE 8-10

~~TOP SECRET~~



~~TOP SECRET~~

EXPOSURE POINTS

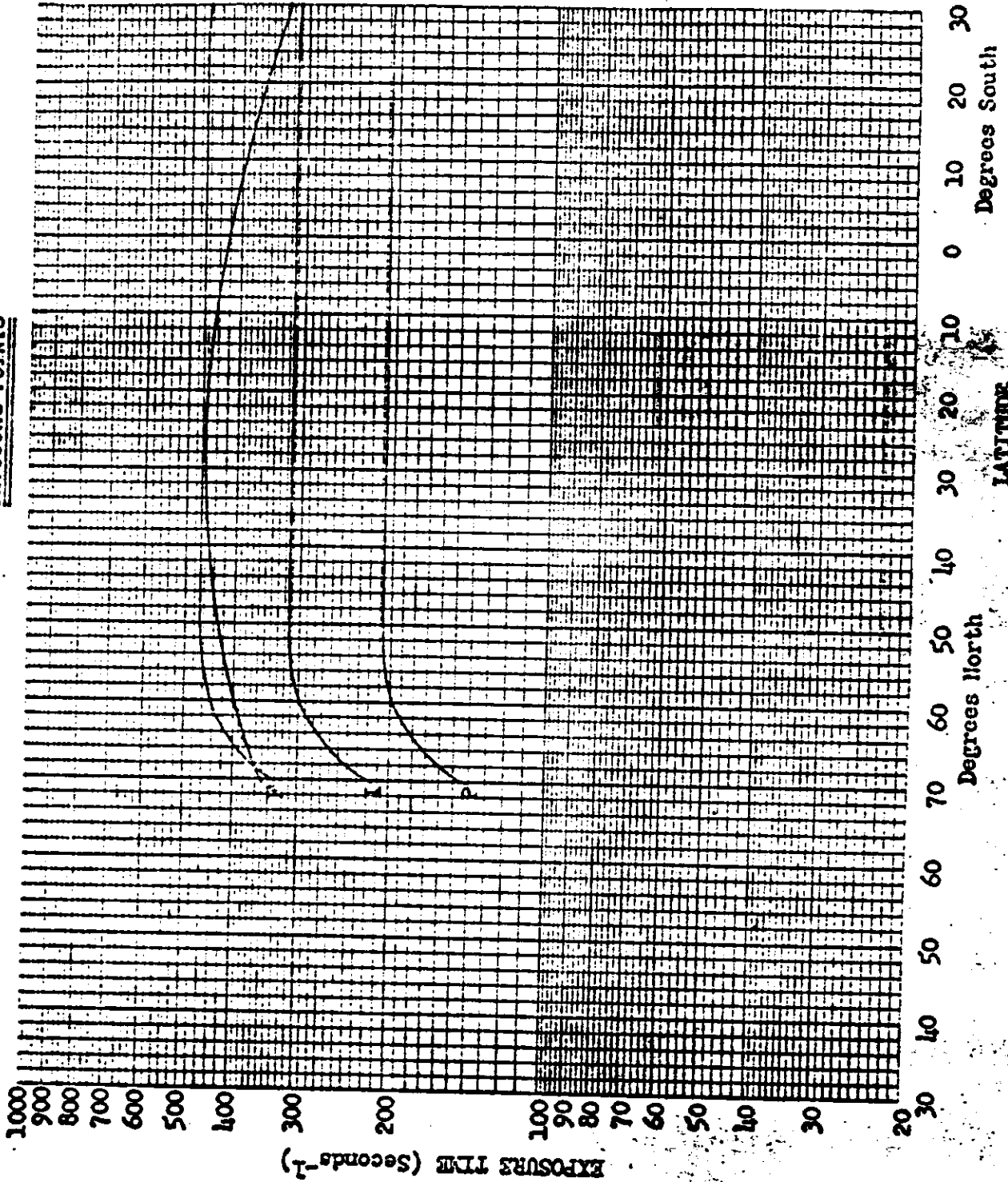

Mission No: 1023

Payload No: J-23

Camera No: 171

Pass No: 88

Launch Date: 8/17/65

Launch Time: 2100 Z

Slit Width: .150

Filter Type: Wratten 21

Film Type: 3404

~~TOP SECRET~~

FIGURE 8-11

~~TOP SECRET~~

EXPOSURE POINTS

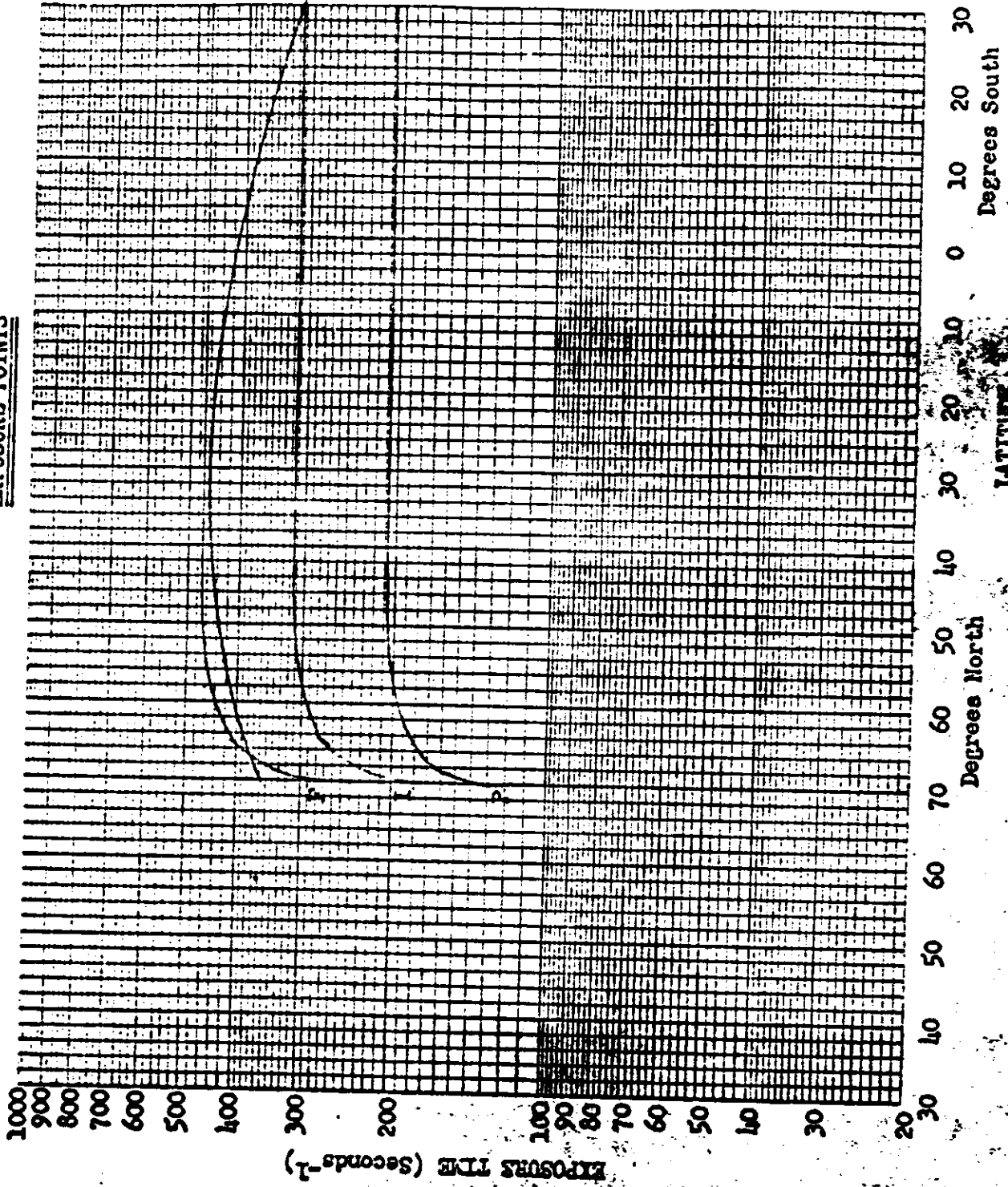

LATITUDE  
FIGURE 8-13

Mission No: 1023

Payload No: J-23

Camera No: 171

Pass No: 120

Launch Date: 8/17/65

Launch Time: 2100 Z

Slit Width: .150

Filter Type: Wratten 23

Film Type: 3604

~~TOP SECRET~~

SECTION 9

DIFFUSE DENSITY MEASUREMENTS

AFSPPL measures the diffuse density of the original negative. Measurements are made of the minimum and maximum terrain density as well as the maximum density of clouds. This data is supplied to A/P in punched card form for further analysis. Also included on the cards are other general data such as illumination conditions, exposure time, location and distance to target. This data is now published in its entirety in the AFSPPL report hence will no longer be included in this report.

The diffuse density measurements made by AFSPPL were computer sorted at A/P to permit analysis of the density ranges encountered at the three processing levels. A study of sorting techniques showed that no absolute method was available to separate the density values as the accuracy of the Processing History published by [redacted] appears rather low and processing transition phases are not accounted for. The sorting techniques selected uses the base plus fog density values where measurements up to 0.09 density are considered as having received Primary processing, 0.10 to 0.17 as Intermediate and above 0.17 density as Full. The percentage of original negative that was processed at each level, based on the computer sort, is tabulated below with the predicted and reported processing percentages.

<u>Mission</u>	<u>Camera</u>		<u>Primary</u>	<u>Intermediate</u>	<u>Full</u>
1023-1	FWD	Predicted	0	5	95
		Reported	19	54	27
		Computed	0	72	28
1023-1	AFT	Predicted	0	11	89
		Reported	0	39	61
		Computed	0	42	58
1023-2	FWD	Predicted	0	7	93
		Reported	0	19	81
		Computed	0	18	82
1023-2	AFT	Predicted	0	3	97
		Reported	0	34	66
		Computed	0	28	72

~~TOP SECRET~~

The correlation between the reported and computed percentages at the three processing levels is very good except for the FWD camera of Mission 1023-1. As previously noted, [REDACTED] reported an equipment malfunction which increased the intermediate percentage significantly.

The tabulations of density frequency distributions for Missions 1023-1 and 1023-2 are shown in Tables 9-1 through 9-4. The graphical presentation of the density distribution are computer plotted in Figures 9-1 through 9-36. Analysis of these plots and the associated mean and median density values show that no significant variation in density was present in Mission 1023-2.

Table 9-7 shows the distribution of the minimum terrain density measurements that are within and outside of the desired control range of 0.40 to 0.90 density. Excluding the FWD camera data from Mission 1023-1, approximately 95% of all minimum density values are above 0.30 density.

~~TOP SECRET~~

DENSITY VALUE	PRIMARY			INTERMEDIATE			FULL			ALL LEVELS		
	MIN	MAX	LIM	MIN	MAX	LIM	MIN	MAX	LIM	MIN	MAX	LIM
0.01	0	0	0	0	0	0	0	0	0	0	0	0
0.02	0	0	0	0	0	0	0	0	0	0	0	0
0.03	0	0	0	0	0	0	0	0	0	0	0	0
0.04	0	0	0	0	0	0	0	0	0	0	0	0
0.05	0	0	0	0	0	0	0	0	0	0	0	0
0.06	0	0	0	0	0	0	0	0	0	0	0	0
0.07	0	0	0	0	0	0	0	0	0	0	0	0
0.08	0	0	0	0	0	0	0	0	0	0	0	0
0.09	0	0	0	0	0	0	0	0	0	0	0	0
0.10	0	0	0	0	0	0	0	0	0	0	0	0
0.11	0	0	0	0	0	0	0	0	0	0	0	0
0.12	0	0	0	0	0	0	0	0	0	0	0	0
0.13	0	0	0	0	0	0	0	0	0	0	0	0
0.14	0	0	0	0	0	0	0	0	0	0	0	0
0.15	0	0	0	0	0	0	0	0	0	0	0	0
0.16	0	0	0	0	0	0	0	0	0	0	0	0
0.17	0	0	0	0	0	0	0	0	0	0	0	0
0.18	0	0	0	0	0	0	0	0	0	0	0	0
0.19	0	0	0	0	0	0	0	0	0	0	0	0
0.20	0	0	0	0	0	0	0	0	0	0	0	0
0.21	0	0	0	0	0	0	0	0	0	0	0	0
0.22	0	0	0	0	0	0	0	0	0	0	0	0
0.23	0	0	0	0	0	0	0	0	0	0	0	0
0.24	0	0	0	0	0	0	0	0	0	0	0	0
0.25	0	0	0	1	0	0	0	0	0	1	0	0
0.26	0	0	0	0	0	0	0	0	0	0	0	0
0.27	0	0	0	0	0	0	0	0	0	0	0	0
0.28	0	0	0	0	0	0	0	0	0	0	0	0
0.29	0	0	0	0	0	0	0	0	0	0	0	0
0.30	0	0	0	1	0	0	0	0	0	1	0	0
0.31	0	0	0	0	0	0	0	0	0	0	0	0
0.32	0	0	0	1	0	0	0	0	0	1	0	0
0.33	0	0	0	0	0	0	0	0	0	0	0	0
0.34	0	0	0	1	0	0	0	0	0	1	0	0
0.35	0	0	0	0	0	0	0	0	0	0	0	0
0.36	0	0	0	0	0	0	0	0	0	0	0	0
0.37	0	0	0	0	0	0	0	0	0	0	0	0
0.38	0	0	0	0	0	0	0	0	0	0	0	0
0.39	0	0	0	0	0	0	0	0	0	0	0	0
0.40	0	0	0	0	0	0	0	0	0	0	0	0
0.41	0	0	0	0	0	0	0	0	0	0	0	0
0.42	0	0	0	0	0	0	0	0	0	0	0	0
0.43	0	0	0	0	0	0	0	0	0	0	0	0
0.44	0	0	0	0	0	0	0	0	0	0	0	0
0.45	0	0	0	0	0	0	0	0	0	0	0	0
0.46	0	0	0	0	0	0	0	0	0	0	0	0
0.47	0	0	0	0	0	0	0	0	0	0	0	0
0.48	0	0	0	0	0	0	0	0	0	0	0	0
0.49	0	0	0	0	0	0	0	0	0	0	0	0
0.50	0	0	0	0	0	0	0	0	0	0	0	0
SUBTOTAL				22	22	22	22	22	22	22	22	22

TABLE 9-1

DENSITY VALUE	PRIMARY			INTERMEDIATE			FULL			ALL LEVELS		
	MIN	MAX	LIM	MIN	MAX	LIM	MIN	MAX	LIM	MIN	MAX	LIM
0.51	0	0	0	4	1	0	1	0	0	5	1	0
0.52	0	0	0	4	1	0	1	0	0	5	1	0
0.53	0	0	0	4	1	0	1	0	0	5	1	0
0.54	0	0	0	4	1	0	1	0	0	5	1	0
0.55	0	0	0	4	1	0	1	0	0	5	1	0
0.56	0	0	0	4	1	0	1	0	0	5	1	0
0.57	0	0	0	4	1	0	1	0	0	5	1	0
0.58	0	0	0	4	1	0	1	0	0	5	1	0
0.59	0	0	0	4	1	0	1	0	0	5	1	0
0.60	0	0	0	4	1	0	1	0	0	5	1	0
0.61	0	0	0	4	1	0	1	0	0	5	1	0
0.62	0	0	0	4	1	0	1	0	0	5	1	0
0.63	0	0	0	4	1	0	1	0	0	5	1	0
0.64	0	0	0	4	1	0	1	0	0	5	1	0
0.65	0	0	0	4	1	0	1	0	0	5	1	0
0.66	0	0	0	4	1	0	1	0	0	5	1	0
0.67	0	0	0	4	1	0	1	0	0	5	1	0
0.68	0	0	0	4	1	0	1	0	0	5	1	0
0.69	0	0	0	4	1	0	1	0	0	5	1	0
0.70	0	0	0	4	1	0	1	0	0	5	1	0
0.71	0	0	0	4	1	0	1	0	0	5	1	0
0.72	0	0	0	4	1	0	1	0	0	5	1	0
0.73	0	0	0	4	1	0	1	0	0	5	1	0
0.74	0	0	0	4	1	0	1	0	0	5	1	0
0.75	0	0	0	4	1	0	1	0	0	5	1	0
0.76	0	0	0	4	1	0	1	0	0	5	1	0
0.77	0	0	0	4	1	0	1	0	0	5	1	0
0.78	0	0	0	4	1	0	1	0	0	5	1	0
0.79	0	0	0	4	1	0	1	0	0	5	1	0
0.80	0	0	0	4	1	0	1	0	0	5	1	0
0.81	0	0	0	4	1	0	1	0	0	5	1	0
0.82	0	0	0	4	1	0	1	0	0	5	1	0
0.83	0	0	0	4	1	0	1	0	0	5	1	0
0.84	0	0	0	4	1	0	1	0	0	5	1	0
0.85	0	0	0	4	1	0	1	0	0	5	1	0
0.86	0	0	0	4	1	0	1	0	0	5	1	0
0.87	0	0	0	4	1	0	1	0	0	5	1	0
0.88	0	0	0	4	1	0	1	0	0	5	1	0
0.89	0	0	0	4	1	0	1	0	0	5	1	0
0.90	0	0	0	4	1	0	1	0	0	5	1	0
0.91	0	0	0	4	1	0	1	0	0	5	1	0
0.92	0	0	0	4	1	0	1	0	0	5	1	0
0.93	0	0	0	4	1	0	1	0	0	5	1	0
0.94	0	0	0	4	1	0	1	0	0	5	1	0
0.95	0	0	0	4	1	0	1	0	0	5	1	0
0.96	0	0	0	4	1	0	1	0	0	5	1	0
0.97	0	0	0	4	1	0	1	0	0	5	1	0
0.98	0	0	0	4	1	0	1	0	0	5	1	0
0.99	0	0	0	4	1	0	1	0	0	5	1	0
1.00	0	0	0	4	1	0	1	0	0	5	1	0
SUBTOTAL	0	0	0	3	5	0	11	18	1	49	74	1

TABLE 9-1

MISSION • 1023-117 • INSTRUMENT • FREQ • DENSITY FREQ DISTR

DENSITY VALUE	PRIMARY			INTERMEDIATE			FULL			ALL LEVELS		
	MIN	MAX	LIM	MIN	MAX	LIM	MIN	MAX	LIM	MIN	MAX	LIM
1.01	0	0	0	0	2	0	0	1	0	0	3	0
1.02	0	0	0	0	1	0	0	0	0	0	1	0
1.03	0	0	0	0	2	0	0	0	0	0	2	0
1.04	0	0	0	0	1	0	0	0	0	0	1	0
1.05	0	0	0	0	0	0	0	0	0	0	0	0
1.06	0	0	0	0	0	0	0	0	0	0	0	0
1.07	0	0	0	0	0	0	0	0	0	0	0	0
1.08	0	0	0	0	0	0	0	0	0	0	0	0
1.09	0	0	0	0	0	0	0	0	0	0	0	0
1.10	0	0	0	0	0	0	0	0	0	0	0	0
1.11	0	0	0	0	0	0	0	0	0	0	0	0
1.12	0	0	0	0	0	0	0	0	0	0	0	0
1.13	0	0	0	0	0	0	0	0	0	0	0	0
1.14	0	0	0	0	0	0	0	0	0	0	0	0
1.15	0	0	0	0	0	0	0	0	0	0	0	0
1.16	0	0	0	0	0	0	0	0	0	0	0	0
1.17	0	0	0	0	0	0	0	0	0	0	0	0
1.18	0	0	0	0	0	0	0	0	0	0	0	0
1.19	0	0	0	0	0	0	0	0	0	0	0	0
1.20	0	0	0	0	0	0	0	0	0	0	0	0
1.21	0	0	0	0	0	0	0	0	0	0	0	0
1.22	0	0	0	0	0	0	0	0	0	0	0	0
1.23	0	0	0	0	0	0	0	0	0	0	0	0
1.24	0	0	0	0	0	0	0	0	0	0	0	0
1.25	0	0	0	0	0	0	0	0	0	0	0	0
1.26	0	0	0	0	0	0	0	0	0	0	0	0
1.27	0	0	0	0	0	0	0	0	0	0	0	0
1.28	0	0	0	0	0	0	0	0	0	0	0	0
1.29	0	0	0	0	0	0	0	0	0	0	0	0
1.30	0	0	0	0	0	0	0	0	0	0	0	0
1.31	0	0	0	0	0	0	0	0	0	0	0	0
1.32	0	0	0	0	0	0	0	0	0	0	0	0
1.33	0	0	0	0	0	0	0	0	0	0	0	0
1.34	0	0	0	0	0	0	0	0	0	0	0	0
1.35	0	0	0	0	0	0	0	0	0	0	0	0
1.36	0	0	0	0	0	0	0	0	0	0	0	0
1.37	0	0	0	0	0	0	0	0	0	0	0	0
1.38	0	0	0	0	0	0	0	0	0	0	0	0
1.39	0	0	0	0	0	0	0	0	0	0	0	0
1.40	0	0	0	0	0	0	0	0	0	0	0	0
1.41	0	0	0	0	0	0	0	0	0	0	0	0
1.42	0	0	0	0	0	0	0	0	0	0	0	0
1.43	0	0	0	0	0	0	0	0	0	0	0	0
1.44	0	0	0	0	0	0	0	0	0	0	0	0
1.45	0	0	0	0	0	0	0	0	0	0	0	0
1.46	0	0	0	0	0	0	0	0	0	0	0	0
1.47	0	0	0	0	0	0	0	0	0	0	0	0
1.48	0	0	0	0	0	0	0	0	0	0	0	0
1.49	0	0	0	0	0	0	0	0	0	0	0	0
1.50	0	0	0	0	0	0	0	0	0	0	0	0
SUBTOTAL	0	0	0	3	10	4	5	4	0	1	3	14

TABLE 9-1

DENSITY VALUE	PRIMARY			INTERMEDIATE			FULL			ALL LEVELS		
	MIN	MAX	LIM	MIN	MAX	LIM	MIN	MAX	LIM	MIN	MAX	LIM
1.51	0	0	0	0	3	0	0	0	0	0	3	0
1.52	0	0	0	0	0	0	0	0	0	0	0	0
1.53	0	0	0	0	4	0	0	0	0	0	4	0
1.54	0	0	0	0	0	1	0	0	0	0	1	0
1.55	0	0	0	0	0	1	0	0	0	0	1	0
1.56	0	0	0	0	0	1	0	0	0	0	1	0
1.57	0	0	0	0	0	0	0	0	0	0	0	0
1.58	0	0	0	0	2	0	0	0	0	0	2	0
1.59	0	0	0	0	6	2	0	0	0	0	6	2
1.60	0	0	0	0	0	2	0	0	0	0	2	0
1.61	0	0	0	0	1	2	0	0	0	0	1	2
1.62	0	0	0	0	1	1	0	0	0	0	1	1
1.63	0	0	0	0	0	1	0	0	0	0	1	0
1.64	0	0	0	0	0	1	0	0	0	0	1	0
1.65	0	0	0	0	0	1	0	0	0	0	1	0
1.66	0	0	0	0	0	0	0	0	0	0	0	0
1.67	0	0	0	0	0	0	0	0	0	0	0	0
1.68	0	0	0	0	0	0	0	0	0	0	0	0
1.69	0	0	0	0	0	0	0	0	0	0	0	0
1.70	0	0	0	0	0	0	0	0	0	0	0	0
1.71	0	0	0	0	0	1	0	0	0	0	1	0
1.72	0	0	0	0	0	1	0	0	0	0	1	0
1.73	0	0	0	0	0	3	0	0	0	0	3	0
1.74	0	0	0	0	0	0	0	0	0	0	0	0
1.75	0	0	0	0	0	0	0	0	0	0	0	0
1.76	0	0	0	0	0	0	0	0	0	0	0	0
1.77	0	0	0	0	0	0	0	0	0	0	0	0
1.78	0	0	0	0	0	0	0	0	0	0	0	0
1.79	0	0	0	0	0	1	0	0	0	0	1	0
1.80	0	0	0	0	0	3	0	0	0	0	3	0
1.81	0	0	0	0	0	1	0	0	0	0	1	0
1.82	0	0	0	0	0	1	0	0	0	0	1	0
1.83	0	0	0	0	0	1	0	0	0	0	1	0
1.84	0	0	0	0	0	1	0	0	0	0	1	0
1.85	0	0	0	0	0	0	0	0	0	0	0	0
1.86	0	0	0	0	0	0	0	0	0	0	0	0
1.87	0	0	0	0	0	0	0	0	0	0	0	0
1.88	0	0	0	0	0	1	0	0	0	0	1	0
1.89	0	0	0	0	0	1	0	0	0	0	1	0
1.90	0	0	0	0	0	7	0	0	0	0	7	0
1.91	0	0	0	0	0	1	0	0	0	0	1	0
1.92	0	0	0	0	0	5	0	0	0	0	5	0
1.93	0	0	0	0	0	1	0	0	0	0	1	0
1.94	0	0	0	0	0	1	0	0	0	0	1	0
1.95	0	0	0	0	0	1	0	0	0	0	1	0
1.96	0	0	0	0	0	2	0	0	0	0	2	0
1.97	0	0	0	0	0	4	0	0	0	0	4	0
1.98	0	0	0	0	0	4	0	0	0	0	4	0
1.99	0	0	0	0	0	1	0	0	0	0	1	0
2.00	0	0	0	0	0	2	0	0	0	0	2	0
SUBTOTAL	0	0	0	0	30	59	0	17	15	0	47	74

~~TOP SECRET~~

TABLE 9-1



~~TOP SECRET~~

MISSION • 1023-1 • INSTRUMENT • FRWD 12-06-65 DENSITY FREQ DISTR

DENSITY VALUE	PRIMARY			INTERMEDIATE			FULL			ALL LEVELS		
	MIN	MAX	LIM	MIN	MAX	LIM	MIN	MAX	LIM	MIN	MAX	LIM
2.01	0	0	0	0	1	3	0	0	1	0	1	4
2.02	0	0	0	0	1	2	0	0	1	0	1	4
2.03	0	0	0	0	0	1	0	0	1	0	0	2
2.04	0	0	0	0	0	3	0	0	1	0	0	3
2.05	0	0	0	0	2	3	0	0	1	0	0	4
2.06	0	0	0	0	3	3	0	0	1	0	0	4
2.07	0	0	0	0	2	1	0	0	1	0	0	2
2.08	0	0	0	0	0	4	0	0	1	0	0	5
2.09	0	0	0	0	0	4	0	0	1	0	0	4
2.10	0	0	0	0	1	9	0	0	3	0	1	2
2.11	0	0	0	0	0	6	0	0	2	0	0	3
2.12	0	0	0	0	0	5	0	0	1	0	0	4
2.13	0	0	0	0	0	5	0	0	1	0	0	6
2.14	0	0	0	0	0	4	0	0	0	0	0	4
2.15	0	0	0	0	0	5	0	0	1	0	0	6
2.16	0	0	0	0	0	5	0	0	1	0	0	4
2.17	0	0	0	0	0	5	0	0	1	0	0	4
2.18	0	0	0	0	0	4	0	0	1	0	0	9
2.19	0	0	0	0	0	2	0	0	3	0	0	2
2.20	0	0	0	0	0	3	0	0	4	0	0	3
2.21	0	0	0	0	0	3	0	0	4	0	0	7
2.22	0	0	0	0	0	5	0	0	2	0	0	7
2.23	0	0	0	0	0	5	0	0	2	0	0	7
2.24	0	0	0	0	0	5	0	0	1	0	0	4
2.25	0	0	0	0	0	5	0	0	1	0	0	6
2.26	0	0	0	0	0	4	0	0	3	0	0	4
2.27	0	0	0	0	0	4	0	0	2	0	0	3
2.28	0	0	0	0	0	6	0	0	4	0	0	3
2.29	0	0	0	0	0	2	0	0	4	0	0	3
2.30	0	0	0	0	0	2	0	0	2	0	0	3
2.31	0	0	0	0	0	1	0	0	1	0	0	1
2.32	0	0	0	0	0	1	0	0	1	0	0	1
2.33	0	0	0	0	0	1	0	0	1	0	0	1
2.34	0	0	0	0	0	0	0	0	1	0	0	1
2.35	0	0	0	0	0	0	0	0	1	0	0	1
2.36	0	0	0	0	0	1	0	0	1	0	0	1
2.37	0	0	0	0	0	1	0	0	1	0	0	1
2.38	0	0	0	0	0	1	0	0	1	0	0	1
2.39	0	0	0	0	0	0	0	0	1	0	0	1
2.40	0	0	0	0	0	0	0	0	1	0	0	1
2.41	0	0	0	0	0	1	0	0	1	0	0	1
2.42	0	0	0	0	0	1	0	0	1	0	0	1
2.43	0	0	0	0	0	0	0	0	1	0	0	0
2.44	0	0	0	0	0	0	0	0	1	0	0	0
2.45	0	0	0	0	0	0	0	0	1	0	0	0
2.46	0	0	0	0	0	0	0	0	1	0	0	0
2.47	0	0	0	0	0	0	0	0	1	0	0	0
2.48	0	0	0	0	0	0	0	0	1	0	0	0
2.49	0	0	0	0	0	0	0	0	1	0	0	0
2.50	0	0	0	0	0	0	0	0	1	0	0	0
SUBTOTAL	0	0	0	0	7	11	0	1	6	0	8	17

~~TOP SECRET~~

TABLE 9-1

MISSION • 1023-1 • INSTRUMENT • FRWD • 12-06-65 • DENSITY FREQ DISTR

DENSITY VALUE	PRIMARY			INTERMEDIATE			FULL			ALL LEVELS		
	MIN	MAX	LIM	MIN	MAX	LIM	MIN	MAX	LIM	MIN	MAX	LIM
2.51	0	0	0	0	0	0	0	0	0	0	0	0
2.52	0	0	0	0	0	0	0	0	0	0	0	0
2.53	0	0	0	0	0	0	0	0	0	0	0	0
2.54	0	0	0	0	0	0	0	0	0	0	0	0
2.55	0	0	0	0	0	0	0	0	0	0	0	0
2.56	0	0	0	0	0	0	0	0	0	0	0	0
2.57	0	0	0	0	0	0	0	0	0	0	0	0
2.58	0	0	0	0	0	0	0	0	0	0	0	0
2.59	0	0	0	0	0	0	0	0	0	0	0	0
2.60	0	0	0	0	0	0	0	0	0	0	0	0
2.61	0	0	0	0	0	0	0	0	0	0	0	0
2.62	0	0	0	0	0	0	0	0	0	0	0	0
2.63	0	0	0	0	0	0	0	0	0	0	0	0
2.64	0	0	0	0	0	0	0	0	0	0	0	0
2.65	0	0	0	0	0	0	0	0	0	0	0	0
2.66	0	0	0	0	0	0	0	0	0	0	0	0
2.67	0	0	0	0	0	0	0	0	0	0	0	0
2.68	0	0	0	0	0	0	0	0	0	0	0	0
2.69	0	0	0	0	0	0	0	0	0	0	0	0
2.70	0	0	0	0	0	0	0	0	0	0	0	0
SUBTOTAL	0	0	0	0	0	0	0	0	0	0	0	0
TOTAL	0	0	0	200	200	177	78	78	77	278	278	254

MISSION 1023-1 INSTR - FRWD 12-06-65 PROCESSING AND EXPOSURE ANALYSIS

PROCESS LEVEL	SAMPLE SIZE	UNDER EXPOSED	UNDER PROCESSED	CORRECT EXP+PROC	OVER PROCESSED	OVER EXPOSED
PRIMARY	0	0 PC	0 PC	0 PC	0 PC	0 PC
INTERMEDIATE	200	4 PC	60 PC	32 PC	2 PC	0 PC
FULL	78	60 PC	0 PC	38 PC	1 PC	0 PC
ALL LEVELS	278	20 PC	44 PC	34 PC	2 PC	0 PC

PROCESS LEVEL	BASE + FOG	UNDER EXPOSED	UNDER PROCESSED	CORRECT EXP+PROC	OVER PROCESSED	OVER EXPOSED
PRIMARY	0.01-0.07	0.01-0.13	0.14-0.39	0.40-0.90	-----	0.91 AND UP
INTERMED	0.10-0.17	0.01-0.20	0.21-0.39	0.40-0.90	0.91-1.34	1.35 AND UP
FULL	0.18 AND UP	0.01-0.39	-----	0.40-0.90	0.91-1.69	1.70 AND UP

TABLE 9-1

MISSION • 1023-1 • INSTR • FRWD • 12-06-65 PLUT OF 0 MIN • TERRAIN • PROCESSING • INTERMEDIATE  
 ARITH MEAN • 0.59 • MEDIAN • 0.35 • STD DEV • 0.18 • RANGE • 0.15 TO 1.26 WITH 200 SAMPLES

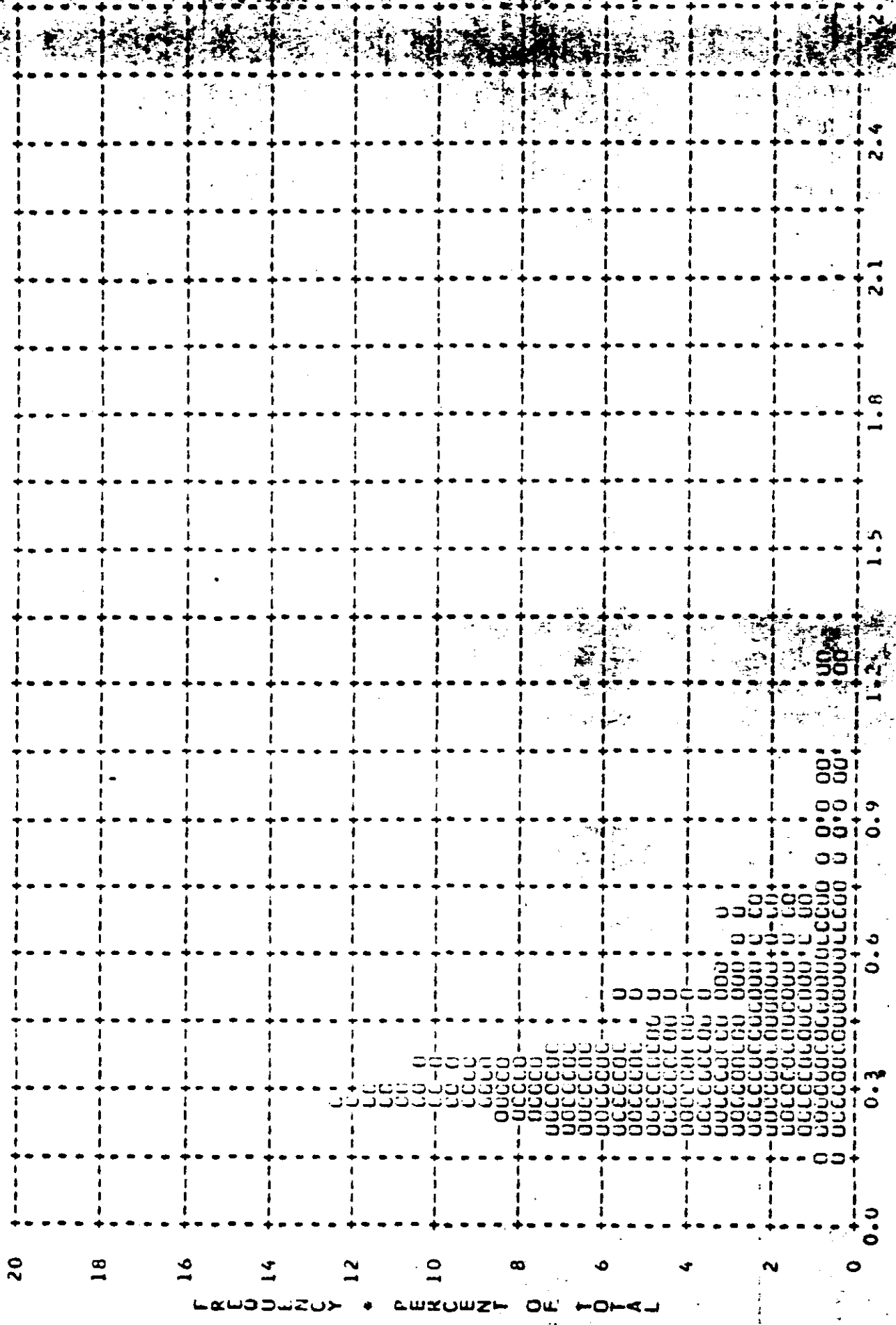

FIGURE 9-1

~~TOP SECRET~~

MISSION • 1023-1 • INSTR • FRWD • 12-06-65 PLOT OF 0 MAX • TERRAIN • PROCESSING • INTERMEDIATE  
ARITH MEAN • 1.22 • MEDIAN • 1.22 • STD DEV • 0.36 • RANGE • 0.43 TO 2.41 WITH 200 SAMPLES

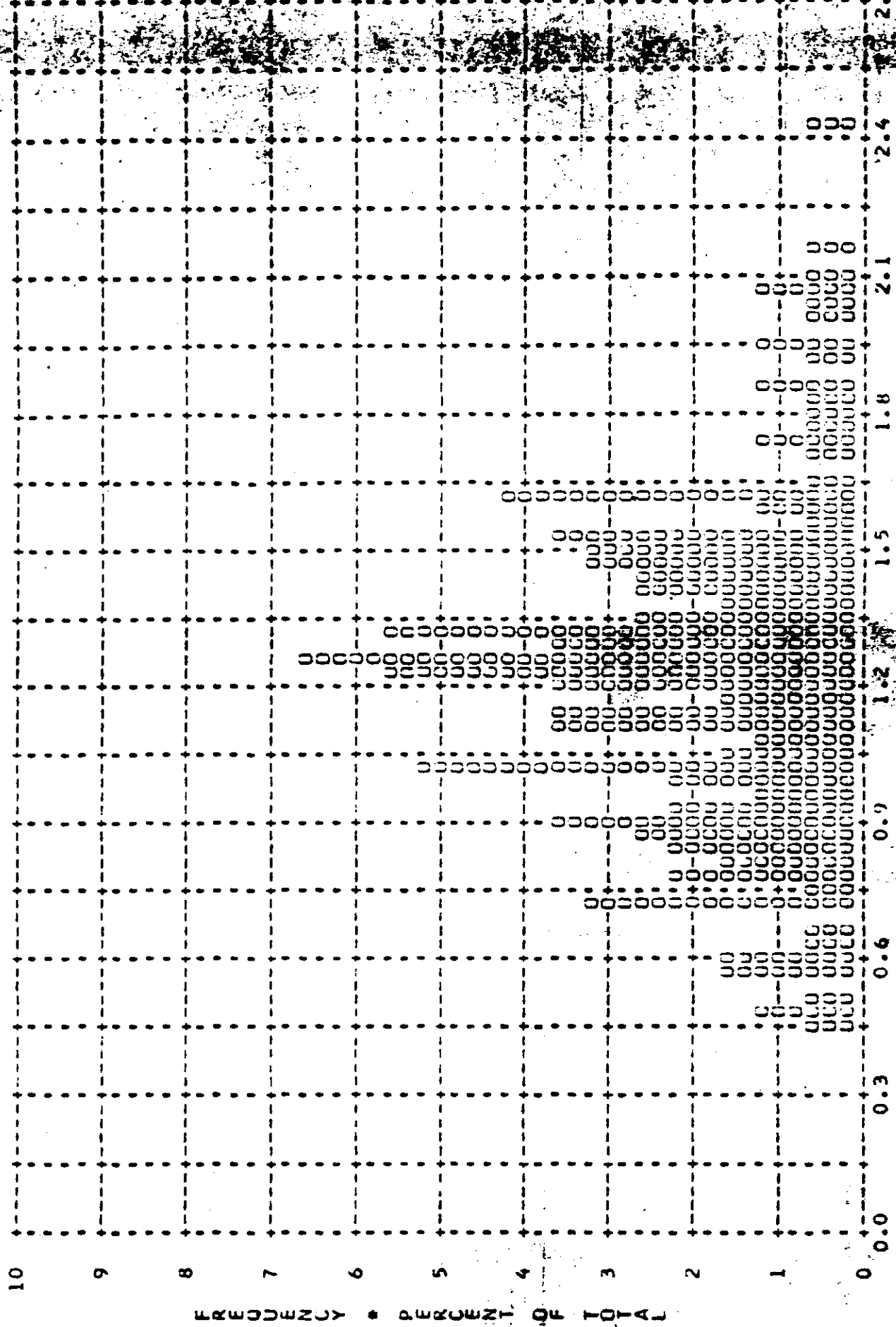

FIGURE 9-2

~~TOP SECRET~~

MISSION • 1023-1 • INSTR • IRWD • 12-06-65 PLOT OF D MAX • CLOUD • PROCESSING • INTERMEDIATE  
 ARITH MEAN • 2.03 • MEDIAN • 2.10 • STD DEV • 0.22 • RANGE • 1.20 TO 2.41 WITH 177 SAMPLES

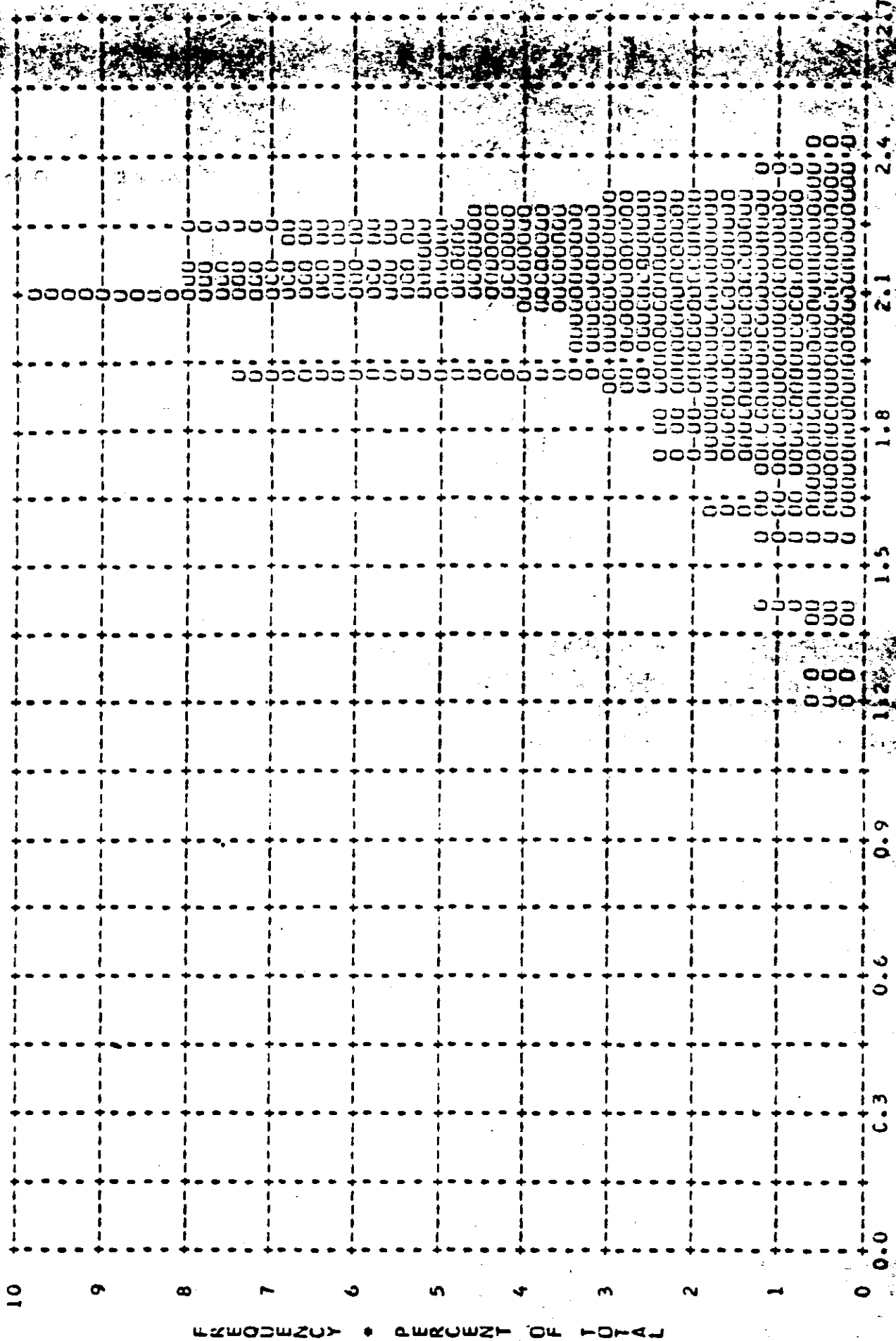

FIGURE 9-3

MISSION • 1023-1 • INSTR • FRWD • 12-06-65 PLOT OF L MIN • TERRAIN • PROCESSING • FULL  
 ARITH MEAN • 0.40 • MEDIAN • 0.37 • STD DEV • 0.12 • RANGE • 0.20 TO 0.91 WITH 78 SAMPLES

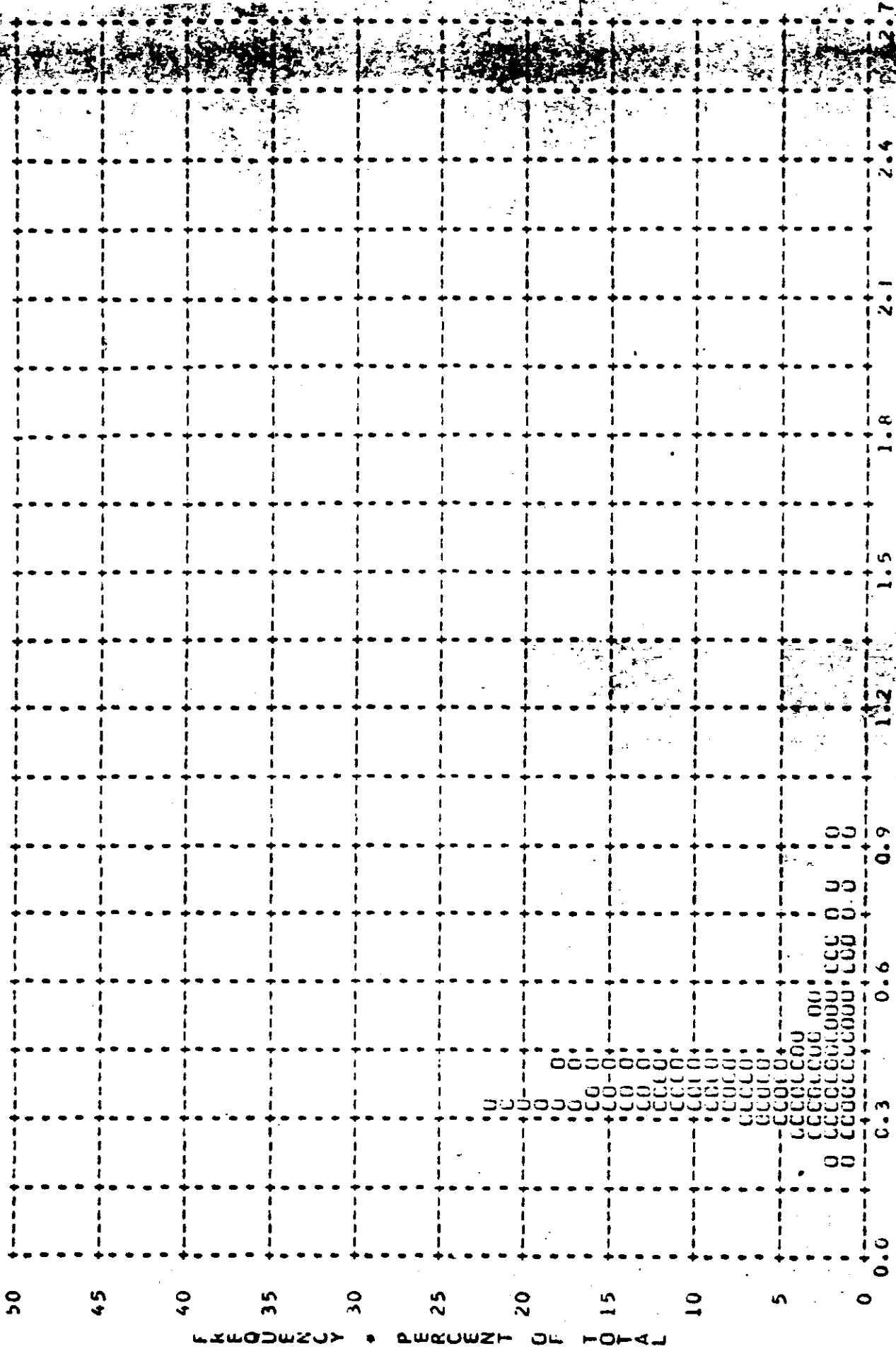

FIGURE 9-4

MISSION • 1023-1 • INSTR • IRWD • 12-06-65 PLOT OF D MAX • TERRAIN • PROCESSING • FULL  
 ARITH MEAN • 1.22 • MEDIAN • 1.18 • STD DEV • 0.36 • RANGE • 0.43 TO 2.12 WITH 78 SAMPLES

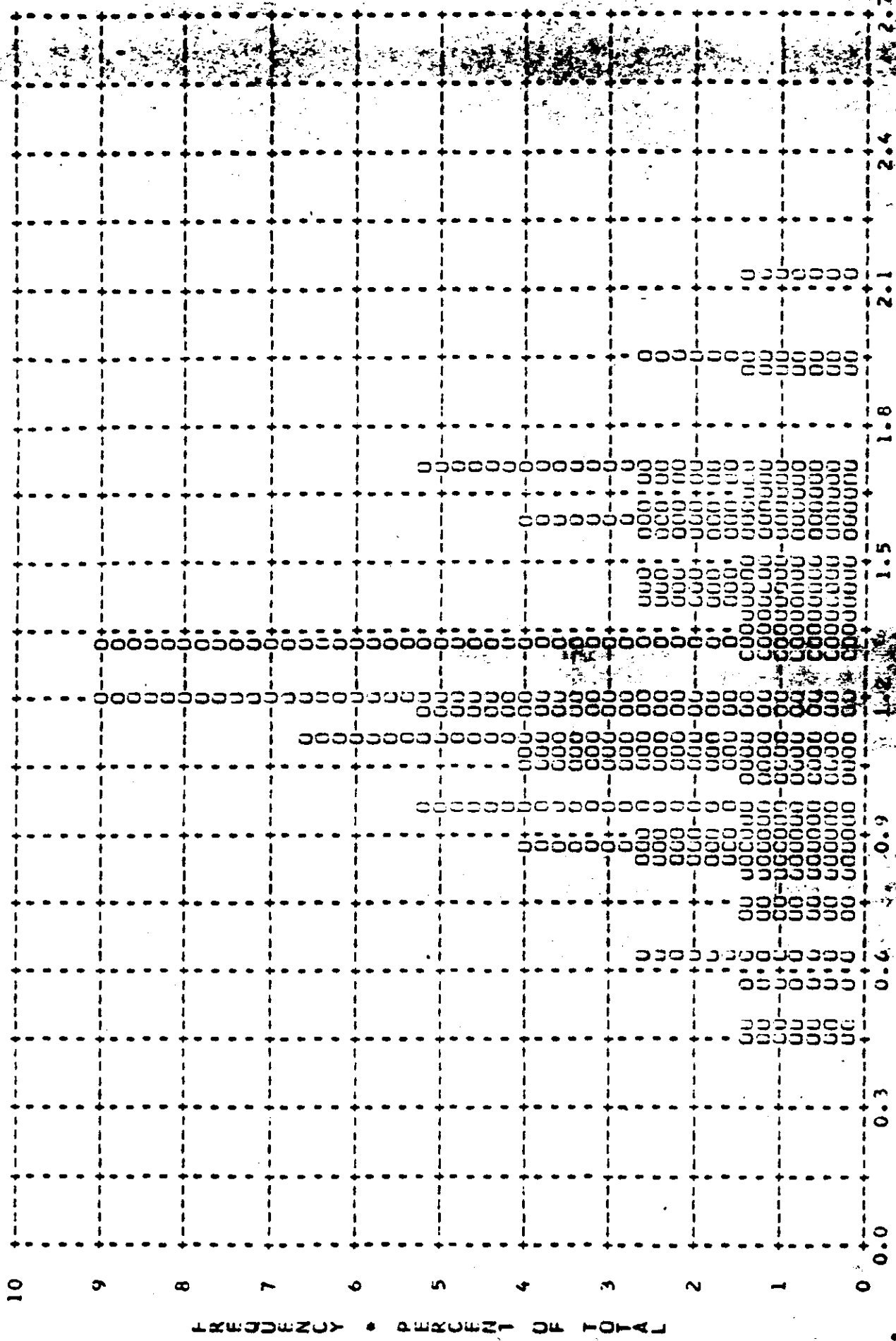

FIGURE 9-5

MISSION • 1023-1 • INSTR • FRWD • 12-06-65 PLOT OF D MAX • CLOUD • PROCESSING • FULL  
 ARITH MEAN • 2.12 • MEDIAN • 2.18 • STD DEV • 0.22 • RANGE • 0.87 TO 2.39 WITH 77 SAMPLES

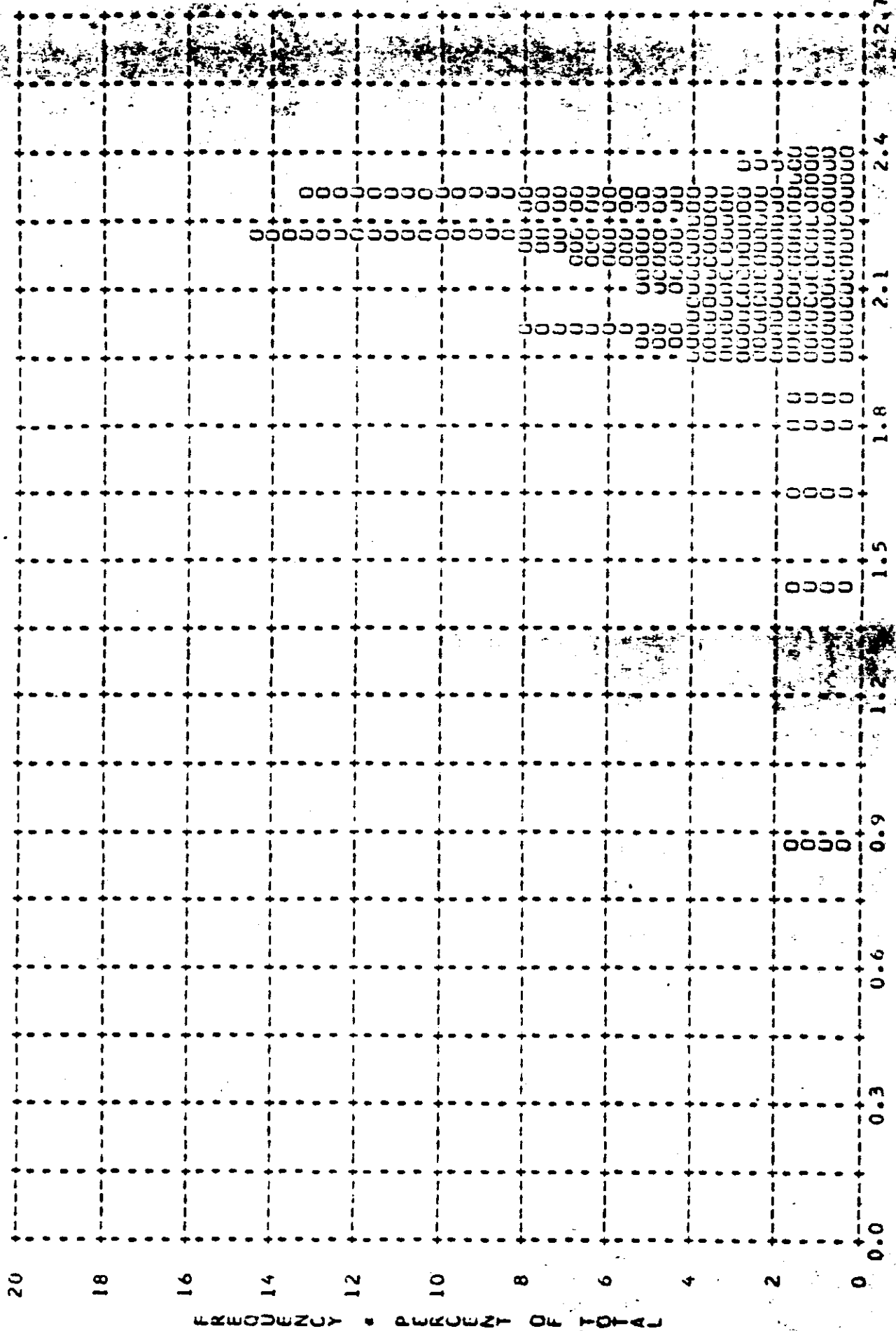

FIGURE 9-6



~~TOP SECRET~~

MISSION • 1023-1 • INSTR • FRWD • 12-06-65 PLOT OF U MIN • TERRAIN • PROCESSING • ALL LEVELS  
ARITH MEAN • 0.39 • MEDIAN • 0.35 • STD DEV • 0.17 • RANGE • 0.15 TO 1.26 WITH 278 SAMPLES

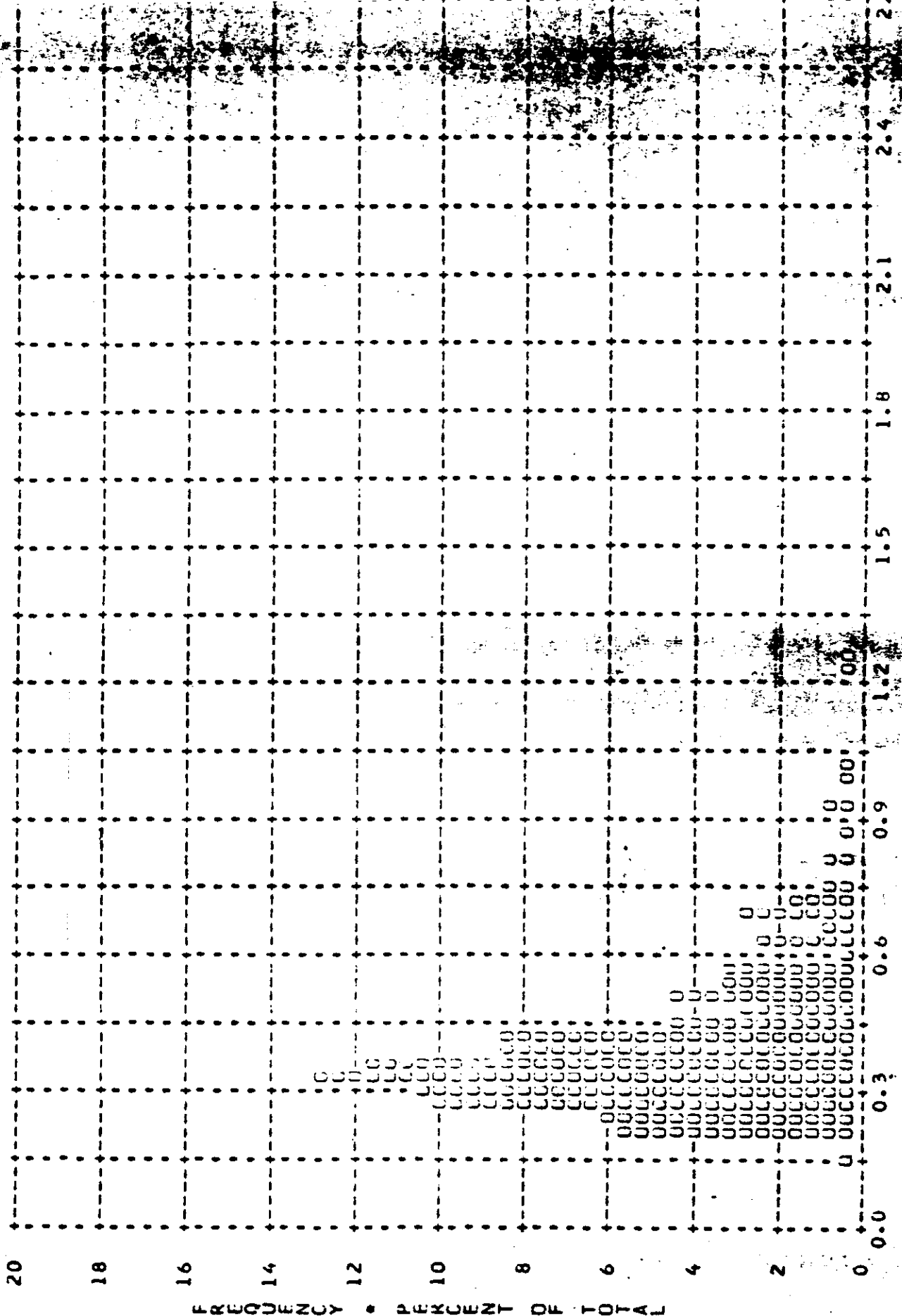

FIGURE 9-7 • DENSITY

~~TOP SECRET~~

MISSION • 1023-1 • F151R • F1WD • 12-06-65 PLOT OF D MAX • TERRAIN • PROCESSING • ALL LEVELS  
ARITH MEAN • 1.22 • MEDIAN • 1.22 • STD DEV • 0.36 • RANGE • 0.43 TO 2.41 WITH 278 SAMPLES

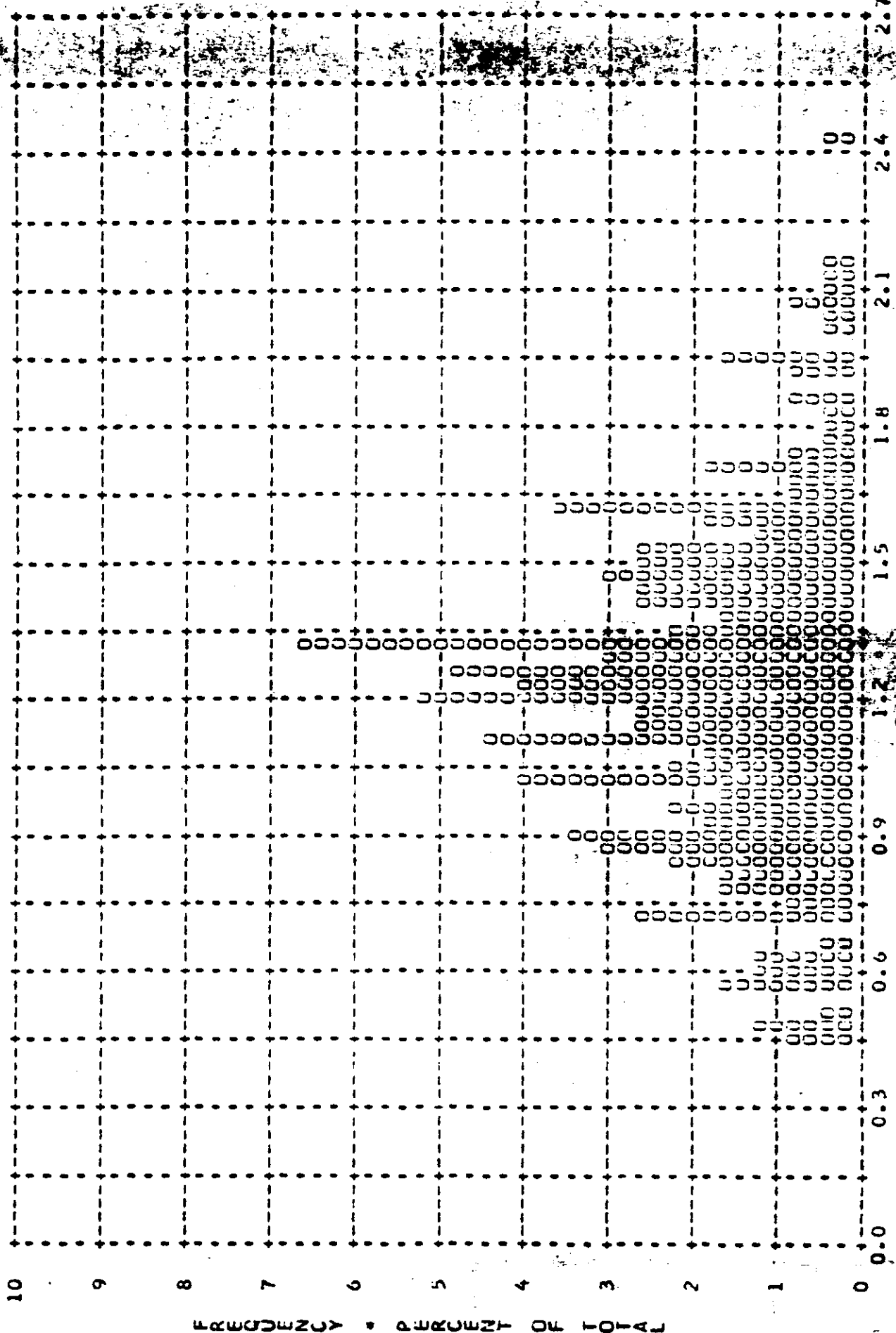

FIGURE 9-8

~~TOP SECRET~~

MISSION \* 1023-1 \* INSIR \* FRWD \* 12-06-65 PLOT OF D MAX \* CLOUD \* PROCESSING \* ALL LEVELS  
ARITH MEAN \* 2.06 \* MEDIAN \* 2.11 \* STD DEV \* 0.22 \* RANGE \* 0.87 TO 2.41 WITH 254 SAMPLES

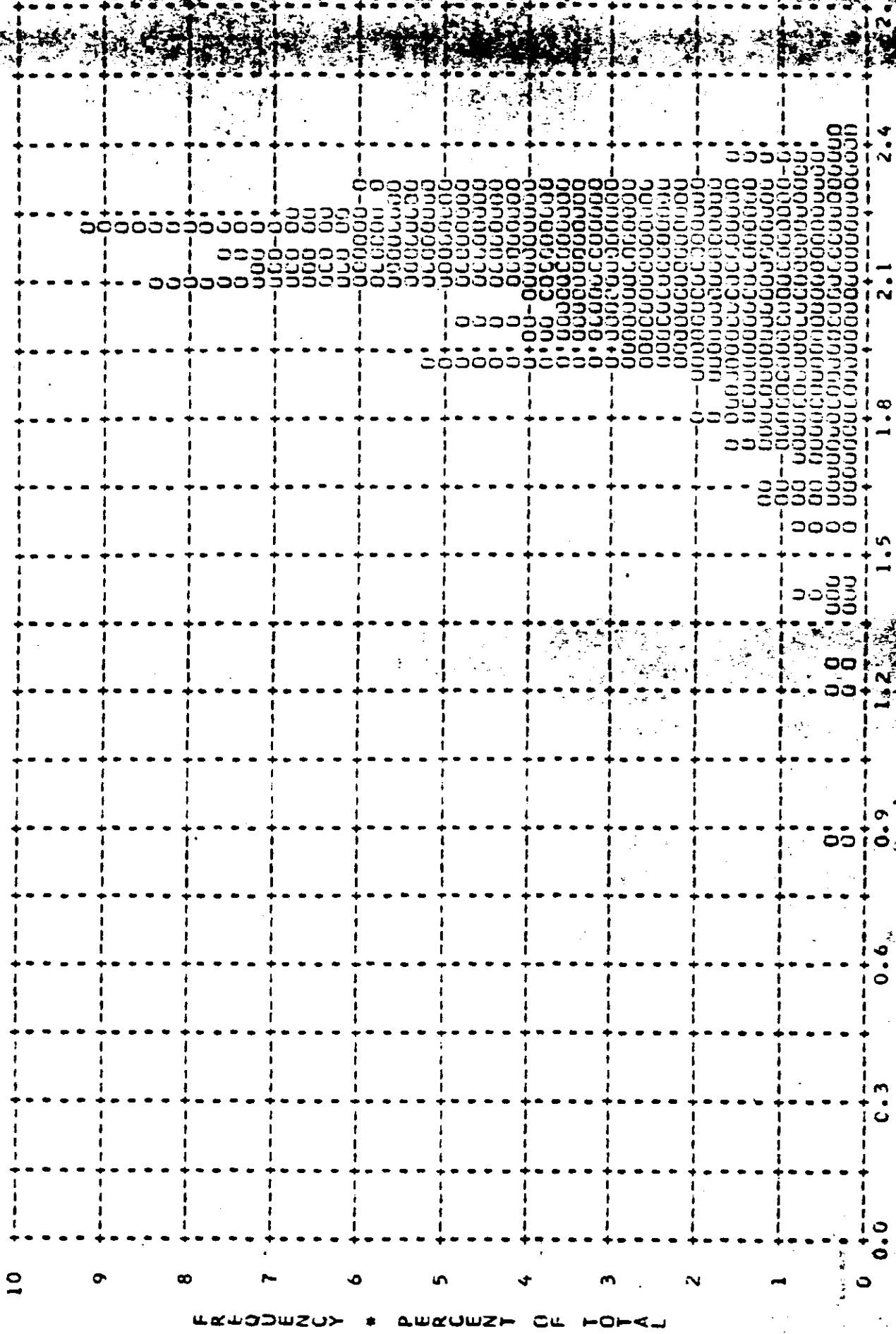

FIGURE 9-9 DENSITY

~~TOP SECRET~~

MISSION • 1023-1 • INSTRUMENT • AFT 12-06-65 DENSITY FREQ DISTR

DENSITY VALUE	PRIMARY			INTERMEDIATE			FULL			ALL LEVELS		
	MIN	MAX	LIM	MIN	MAX	LIM	MIN	MAX	LIM	MIN	MAX	LIM
0.01	0	0	0	0	0	0	0	0	0	0	0	0
0.02	0	0	0	0	0	0	0	0	0	0	0	0
0.03	0	0	0	0	0	0	0	0	0	0	0	0
0.04	0	0	0	0	0	0	0	0	0	0	0	0
0.05	0	0	0	0	0	0	0	0	0	0	0	0
0.06	0	0	0	0	0	0	0	0	0	0	0	0
0.07	0	0	0	0	0	0	0	0	0	0	0	0
0.08	0	0	0	0	0	0	0	0	0	0	0	0
0.09	0	0	0	0	0	0	0	0	0	0	0	0
0.10	0	0	0	0	0	0	0	0	0	0	0	0
0.11	0	0	0	0	0	0	0	0	0	0	0	0
0.12	0	0	0	0	0	0	0	0	0	0	0	0
0.13	0	0	0	0	0	0	0	0	0	0	0	0
0.14	0	0	0	0	0	0	0	0	0	0	0	0
0.15	0	0	0	0	0	0	0	0	0	0	0	0
0.16	0	0	0	0	0	0	0	0	0	0	0	0
0.17	0	0	0	0	0	0	0	0	0	0	0	0
0.18	0	0	0	0	0	0	0	0	0	0	0	0
0.19	0	0	0	0	0	0	0	0	0	0	0	0
0.20	0	0	0	0	0	0	0	0	0	0	0	0
0.21	0	0	0	0	0	0	0	0	0	0	0	0
0.22	0	0	0	0	0	0	0	0	0	0	0	0
0.23	0	0	0	0	0	0	0	0	0	0	0	0
0.24	0	0	0	0	0	0	0	0	0	0	0	0
0.25	0	0	0	0	0	0	0	0	0	0	0	0
0.26	0	0	0	0	0	0	0	0	0	0	0	0
0.27	0	0	0	0	0	0	0	0	0	0	0	0
0.28	0	0	0	0	0	0	0	0	0	0	0	0
0.29	0	0	0	0	0	0	0	0	0	0	0	0
0.30	0	0	0	0	0	0	0	0	0	0	0	0
0.31	0	0	0	0	0	0	0	0	0	0	0	0
0.32	0	0	0	0	0	0	0	0	0	0	0	0
0.33	0	0	0	0	0	0	0	0	0	0	0	0
0.34	0	0	0	0	0	0	0	0	0	0	0	0
0.35	0	0	0	0	0	0	0	0	0	0	0	0
0.36	0	0	0	0	0	0	0	0	0	0	0	0
0.37	0	0	0	0	0	0	0	0	0	0	0	0
0.38	0	0	0	0	0	0	0	0	0	0	0	0
0.39	0	0	0	0	0	0	0	0	0	0	0	0
0.40	0	0	0	0	0	0	0	0	0	0	0	0
0.41	0	0	0	0	0	0	0	0	0	0	0	0
0.42	0	0	0	0	0	0	0	0	0	0	0	0
0.43	0	0	0	0	0	0	0	0	0	0	0	0
0.44	0	0	0	0	0	0	0	0	0	0	0	0
0.45	0	0	0	0	0	0	0	0	0	0	0	0
0.46	0	0	0	0	0	0	0	0	0	0	0	0
0.47	0	0	0	0	0	0	0	0	0	0	0	0
0.48	0	0	0	0	0	0	0	0	0	0	0	0
0.49	0	0	0	0	0	0	0	0	0	0	0	0
0.50	0	0	0	0	0	0	0	0	0	0	0	0
SUBTOTAL	0	0	0	0	0	0	0	0	0	0	0	0

~~TOP SECRET~~

TABLE 9-2

MISSION • 1023-1 • INSTRUMENT • AFT 12-06-65 DENSITY FREQ DISTR

DENSITY VALUE	PRIMARY			INTERMEDIATE			FULL			ALL LEVELS		
	MIN	MAX	LIM	MIN	MAX	LIM	MIN	MAX	LIM	MIN	MAX	LIM
0.51	0	0	0	3	0	0	5	1	0	5	1	0
0.52	0	0	0	3	0	0	3	0	0	5	1	0
0.53	0	0	0	3	0	0	3	0	0	5	1	0
0.54	0	0	0	3	0	0	4	0	0	7	1	0
0.55	0	0	0	3	0	0	5	0	0	6	0	0
0.56	0	0	0	3	0	0	5	0	0	6	0	0
0.57	0	0	0	3	0	0	5	0	0	6	0	0
0.58	0	0	0	3	0	0	5	0	0	6	0	0
0.59	0	0	0	3	0	0	5	0	0	6	0	0
0.60	0	0	0	3	0	0	5	0	0	6	0	0
0.61	0	0	0	3	0	0	5	0	0	6	0	0
0.62	0	0	0	3	0	0	5	0	0	6	0	0
0.63	0	0	0	3	0	0	5	0	0	6	0	0
0.64	0	0	0	3	0	0	5	0	0	6	0	0
0.65	0	0	0	3	0	0	5	0	0	6	0	0
0.66	0	0	0	3	0	0	5	0	0	6	0	0
0.67	0	0	0	3	0	0	5	0	0	6	0	0
0.68	0	0	0	3	0	0	5	0	0	6	0	0
0.69	0	0	0	3	0	0	5	0	0	6	0	0
0.70	0	0	0	3	0	0	5	0	0	6	0	0
0.71	0	0	0	3	0	0	5	0	0	6	0	0
0.72	0	0	0	3	0	0	5	0	0	6	0	0
0.73	0	0	0	3	0	0	5	0	0	6	0	0
0.74	0	0	0	3	0	0	5	0	0	6	0	0
0.75	0	0	0	3	0	0	5	0	0	6	0	0
0.76	0	0	0	3	0	0	5	0	0	6	0	0
0.77	0	0	0	3	0	0	5	0	0	6	0	0
0.78	0	0	0	3	0	0	5	0	0	6	0	0
0.79	0	0	0	3	0	0	5	0	0	6	0	0
0.80	0	0	0	3	0	0	5	0	0	6	0	0
0.81	0	0	0	3	0	0	5	0	0	6	0	0
0.82	0	0	0	3	0	0	5	0	0	6	0	0
0.83	0	0	0	3	0	0	5	0	0	6	0	0
0.84	0	0	0	3	0	0	5	0	0	6	0	0
0.85	0	0	0	3	0	0	5	0	0	6	0	0
0.86	0	0	0	3	0	0	5	0	0	6	0	0
0.87	0	0	0	3	0	0	5	0	0	6	0	0
0.88	0	0	0	3	0	0	5	0	0	6	0	0
0.89	0	0	0	3	0	0	5	0	0	6	0	0
0.90	0	0	0	3	0	0	5	0	0	6	0	0
0.91	0	0	0	3	0	0	5	0	0	6	0	0
0.92	0	0	0	3	0	0	5	0	0	6	0	0
0.93	0	0	0	3	0	0	5	0	0	6	0	0
0.94	0	0	0	3	0	0	5	0	0	6	0	0
0.95	0	0	0	3	0	0	5	0	0	6	0	0
0.96	0	0	0	3	0	0	5	0	0	6	0	0
0.97	0	0	0	3	0	0	5	0	0	6	0	0
0.98	0	0	0	3	0	0	5	0	0	6	0	0
0.99	0	0	0	3	0	0	5	0	0	6	0	0
1.00	0	0	0	3	0	0	5	0	0	6	0	0
SUBTOTAL	0	0	0	47	12	0	56	29	1	103	41	1

TABLE 9-2

DENSITY VALUE	PRIMARY			INTERMEDIATE			FULL			ALL LEVELS		
	MIN	MAX	LIM	MIN	MAX	LIM	MIN	MAX	LIM	MIN	MAX	LIM
1.01	0	0	0	0	0	0	1	0	0	1	0	0
1.02	0	0	0	0	0	0	2	3	0	2	3	0
1.03	0	0	0	0	0	0	0	0	0	0	0	0
1.04	0	0	0	0	0	0	0	0	0	0	0	0
1.05	0	0	0	0	0	0	0	0	0	0	0	0
1.06	0	0	0	0	0	0	0	0	0	0	0	0
1.07	0	0	0	0	0	0	0	0	0	0	0	0
1.08	0	0	0	0	0	0	0	0	0	0	0	0
1.09	0	0	0	0	0	0	0	0	0	0	0	0
1.10	0	0	0	0	0	0	0	0	0	0	0	0
1.11	0	0	0	0	0	0	0	0	0	0	0	0
1.12	0	0	0	0	0	0	0	0	0	0	0	0
1.13	0	0	0	0	0	0	0	0	0	0	0	0
1.14	0	0	0	0	0	0	0	0	0	0	0	0
1.15	0	0	0	0	0	0	0	0	0	0	0	0
1.16	0	0	0	0	0	0	0	0	0	0	0	0
1.17	0	0	0	0	0	0	0	0	0	0	0	0
1.18	0	0	0	0	0	0	0	0	0	0	0	0
1.19	0	0	0	0	0	0	0	0	0	0	0	0
1.20	0	0	0	0	0	0	0	0	0	0	0	0
1.21	0	0	0	0	0	0	0	0	0	0	0	0
1.22	0	0	0	0	0	0	0	0	0	0	0	0
1.23	0	0	0	0	0	0	0	0	0	0	0	0
1.24	0	0	0	0	0	0	0	0	0	0	0	0
1.25	0	0	0	0	0	0	0	0	0	0	0	0
1.26	0	0	0	0	0	0	0	0	0	0	0	0
1.27	0	0	0	0	0	0	0	0	0	0	0	0
1.28	0	0	0	0	0	0	0	0	0	0	0	0
1.29	0	0	0	0	0	0	0	0	0	0	0	0
1.30	0	0	0	0	0	0	0	0	0	0	0	0
1.31	0	0	0	0	0	0	0	0	0	0	0	0
1.32	0	0	0	0	0	0	0	0	0	0	0	0
1.33	0	0	0	0	0	0	0	0	0	0	0	0
1.34	0	0	0	0	0	0	0	0	0	0	0	0
1.35	0	0	0	0	0	0	0	0	0	0	0	0
1.36	0	0	0	0	0	0	0	0	0	0	0	0
1.37	0	0	0	0	0	0	0	0	0	0	0	0
1.38	0	0	0	0	0	0	0	0	0	0	0	0
1.39	0	0	0	0	0	0	0	0	0	0	0	0
1.40	0	0	0	0	0	0	0	0	0	0	0	0
1.41	0	0	0	0	0	0	0	0	0	0	0	0
1.42	0	0	0	0	0	0	0	0	0	0	0	0
1.43	0	0	0	0	0	0	0	0	0	0	0	0
1.44	0	0	0	0	0	0	0	0	0	0	0	0
1.45	0	0	0	0	0	0	0	0	0	0	0	0
1.46	0	0	0	0	0	0	0	0	0	0	0	0
1.47	0	0	0	0	0	0	0	0	0	0	0	0
1.48	0	0	0	0	0	0	0	0	0	0	0	0
1.49	0	0	0	0	0	0	0	0	0	0	0	0
1.50	0	0	0	0	0	0	0	0	0	0	0	0
SUBTOTAL	0	0	0	0	71	0	5	85	4	11	156	9

TABLE 9-2

DENSITY VALUE	PRIMARY			INTERMEDIATE			FULL			ALL LEVELS		
	MIN	MAX	LIM	MIN	MAX	LIM	MIN	MAX	LIM	MIN	MAX	LIM
1.51	0	0	0	0	0	0	0	0	0	0	0	0
1.52	0	0	0	0	0	0	0	0	0	0	0	0
1.53	0	0	0	0	0	0	0	0	0	0	0	0
1.54	0	0	0	0	0	0	0	0	0	0	0	0
1.55	0	0	0	0	0	0	0	0	0	0	0	0
1.56	0	0	0	0	0	0	0	0	0	0	0	0
1.57	0	0	0	0	0	0	0	0	0	0	0	0
1.58	0	0	0	0	0	0	0	0	0	0	0	0
1.59	0	0	0	0	0	0	0	0	0	0	0	0
1.60	0	0	0	0	0	0	0	0	0	0	0	0
1.61	0	0	0	0	0	0	0	0	0	0	0	0
1.62	0	0	0	0	0	0	0	0	0	0	0	0
1.63	0	0	0	0	0	0	0	0	0	0	0	0
1.64	0	0	0	0	0	0	0	0	0	0	0	0
1.65	0	0	0	0	0	0	0	0	0	0	0	0
1.66	0	0	0	0	0	0	0	0	0	0	0	0
1.67	0	0	0	0	0	0	0	0	0	0	0	0
1.68	0	0	0	0	0	0	0	0	0	0	0	0
1.69	0	0	0	0	0	0	0	0	0	0	0	0
1.70	0	0	0	0	0	0	0	0	0	0	0	0
1.71	0	0	0	0	0	0	0	0	0	0	0	0
1.72	0	0	0	0	0	0	0	0	0	0	0	0
1.73	0	0	0	0	0	0	0	0	0	0	0	0
1.74	0	0	0	0	0	0	0	0	0	0	0	0
1.75	0	0	0	0	0	0	0	0	0	0	0	0
1.76	0	0	0	0	0	0	0	0	0	0	0	0
1.77	0	0	0	0	0	0	0	0	0	0	0	0
1.78	0	0	0	0	0	0	0	0	0	0	0	0
1.79	0	0	0	0	0	0	0	0	0	0	0	0
1.80	0	0	0	0	0	0	0	0	0	0	0	0
1.81	0	0	0	0	0	0	0	0	0	0	0	0
1.82	0	0	0	0	0	0	0	0	0	0	0	0
1.83	0	0	0	0	0	0	0	0	0	0	0	0
1.84	0	0	0	0	0	0	0	0	0	0	0	0
1.85	0	0	0	0	0	0	0	0	0	0	0	0
1.86	0	0	0	0	0	0	0	0	0	0	0	0
1.87	0	0	0	0	0	0	0	0	0	0	0	0
1.88	0	0	0	0	0	0	0	0	0	0	0	0
1.89	0	0	0	0	0	0	0	0	0	0	0	0
1.90	0	0	0	0	0	0	0	0	0	0	0	0
1.91	0	0	0	0	0	0	0	0	0	0	0	0
1.92	0	0	0	0	0	0	0	0	0	0	0	0
1.93	0	0	0	0	0	0	0	0	0	0	0	0
1.94	0	0	0	0	0	0	0	0	0	0	0	0
1.95	0	0	0	0	0	0	0	0	0	0	0	0
1.96	0	0	0	0	0	0	0	0	0	0	0	0
1.97	0	0	0	0	0	0	0	0	0	0	0	0
1.98	0	0	0	0	0	0	0	0	0	0	0	0
1.99	0	0	0	0	0	0	0	0	0	0	0	0
2.00	0	0	0	0	0	0	0	0	0	0	0	0
SUBTOTAL												

TABLE 9-2

DENSITY VALUE	PRIMARY			INTERMEDIATE			FULL			ALL LEVELS		
	MIN	MAX	LIM	MIN	MAX	LIM	MIN	MAX	LIM	MIN	MAX	LIM
2.01	0	0	0	0	0	1	0	0	0	0	0	1
2.02	0	0	0	0	0	0	0	0	0	0	0	0
2.03	0	0	0	0	0	0	0	0	0	0	0	0
2.04	0	0	0	0	0	0	0	0	0	0	0	0
2.05	0	0	0	0	0	0	0	0	0	0	0	0
2.06	0	0	0	0	0	0	0	0	0	0	0	0
2.07	0	0	0	0	0	0	0	0	0	0	0	0
2.08	0	0	0	0	0	0	0	0	0	0	0	0
2.09	0	0	0	0	0	0	0	0	0	0	0	0
2.10	0	0	0	0	0	0	0	0	0	0	0	0
2.11	0	0	0	0	0	0	0	0	0	0	0	1
2.12	0	0	0	0	0	0	0	0	0	0	0	0
2.13	0	0	0	0	0	0	0	0	0	0	0	0
2.14	0	0	0	0	0	0	0	0	0	0	0	0
2.15	0	0	0	0	0	0	0	0	0	0	0	0
2.16	0	0	0	0	0	0	0	0	0	0	0	0
2.17	0	0	0	0	0	0	0	0	0	0	0	0
2.18	0	0	0	0	0	0	0	0	0	0	0	0
2.19	0	0	0	0	0	0	0	0	0	0	0	0
2.20	0	0	0	0	0	0	0	0	0	0	0	0
2.21	0	0	0	0	0	0	0	0	0	0	0	0
2.22	0	0	0	0	0	0	0	0	0	0	0	0
2.23	0	0	0	0	0	0	0	0	0	0	0	0
2.24	0	0	0	0	0	0	0	0	0	0	0	0
2.25	0	0	0	0	0	0	0	0	0	0	0	0
2.26	0	0	0	0	0	0	0	0	0	0	0	0
2.27	0	0	0	0	0	0	0	0	0	0	0	0
2.28	0	0	0	0	0	0	0	0	0	0	0	0
2.29	0	0	0	0	0	0	0	0	0	0	0	0
2.30	0	0	0	0	0	0	0	0	0	0	0	0
2.31	0	0	0	0	0	0	0	0	0	0	0	0
2.32	0	0	0	0	0	0	0	0	0	0	0	0
2.33	0	0	0	0	0	0	0	0	0	0	0	0
2.34	0	0	0	0	0	0	0	0	0	0	0	0
2.35	0	0	0	0	0	0	0	0	0	0	0	0
2.36	0	0	0	0	0	0	0	0	0	0	0	0
2.37	0	0	0	0	0	0	0	0	0	0	0	0
2.38	0	0	0	0	0	0	0	0	0	0	0	0
2.39	0	0	0	0	0	0	0	0	0	0	0	0
2.40	0	0	0	0	0	0	0	0	0	0	0	0
2.41	0	0	0	0	0	0	0	0	0	0	0	0
2.42	0	0	0	0	0	0	0	0	0	0	0	0
2.43	0	0	0	0	0	0	0	0	0	0	0	0
2.44	0	0	0	0	0	0	0	0	0	0	0	0
2.45	0	0	0	0	0	0	0	0	0	0	0	0
2.46	0	0	0	0	0	0	0	0	0	0	0	0
2.47	0	0	0	0	0	0	0	0	0	0	0	0
2.48	0	0	0	0	0	0	0	0	0	0	0	0
2.49	0	0	0	0	0	0	0	0	0	0	0	0
2.50	0	0	0	0	0	0	0	0	0	0	0	0
SUBTOTAL	0	0	0	0	0	0	0	0	0	0	0	0

TABLE 9-2



~~TOP SECRET~~ [REDACTED]

MISSION • 1023-1 • INSTRUMENT • AFT 12-06-65 DENSITY FREQ DISTR

DENSITY VALUE	PRIMARY			INTERMEDIATE			FULL			ALL LEVELS		
	MIN	MAX	LIM	MIN	MAX	LIM	MIN	MAX	LIM	MIN	MAX	LIM
2.51	0	0	0	0	0	0	0	0	0	0	0	0
2.52	0	0	0	0	0	0	0	0	0	0	0	0
2.53	0	0	0	0	0	0	0	0	0	0	0	0
2.54	0	0	0	0	0	0	0	0	0	0	0	0
2.55	0	0	0	0	0	0	0	0	0	0	0	0
2.56	0	0	0	0	0	0	0	0	0	0	0	0
2.57	0	0	0	0	0	0	0	0	0	0	0	0
2.58	0	0	0	0	0	0	0	0	0	0	0	0
2.59	0	0	0	0	0	0	0	0	0	0	0	0
2.60	0	0	0	0	0	0	0	0	0	0	0	0
2.61	0	0	0	0	0	0	0	0	0	0	0	0
2.62	0	0	0	0	0	0	0	0	0	0	0	0
2.63	0	0	0	0	0	0	0	0	0	0	0	0
2.64	0	0	0	0	0	0	0	0	0	0	0	0
2.65	0	0	0	0	0	0	0	0	0	0	0	0
2.66	0	0	0	0	0	0	0	0	0	0	0	0
2.67	0	0	0	0	0	0	0	0	0	0	0	0
2.68	0	0	0	0	0	0	0	0	0	0	0	0
2.69	0	0	0	0	0	0	0	0	0	0	0	0
2.70	0	0	0	0	0	0	0	0	0	0	0	0
SUBTOTAL	0	0	0	0	0	0	0	0	0	0	0	0
TOTAL	0	0	0	113	113	103	155	155	153	268	268	256

MISSION 1023-1 INSTR - AFT 12-06-65 PROCESSING AND EXPOSURE ANALYSIS

PROCESS LEVEL	SAMPLE SIZE	UNDER EXPOSED	UNDER PROCESSED	CORRECT EXP+PROC	OVER PROCESSED	OVER EXPOSED
PRIMARY	0	0 PC	0 PC	0 PC	0 PC	0 PC
INTERMEDIATE	113	1 PC	34 PC	54 PC	11 PC	1 PC
FULL	155	22 PC	0 PC	73 PC	5 PC	0 PC
ALL LEVELS	268	13 PC	14 PC	65 PC	7 PC	0 PC

PROCESS LEVEL	BASE + FCG	UNDER EXPOSED	UNDER PROCESSED	CORRECT EXP+PROC	OVER PROCESSED	OVER EXPOSED
PRIMARY	0.01-0.09	0.01-0.13	0.14-0.39	0.40-0.90	-----	0.91 AND UP
INTERMED	0.10-0.17	0.01-0.20	0.21-0.39	0.40-0.90	0.91-1.34	1.35 AND UP
FULL	0.18 AND UP	0.01-0.39	-----	0.40-0.90	0.91-1.69	1.70 AND UP

~~TOP SECRET~~ [REDACTED]

TABLE 9-2

MISSION • 1023-1 • INSTR • AFT • 12-06-65 PLOT OF D MIN • TERRAIN • PROCESSING • INTERMEDIATE  
 ARITH MEAN • 0.55 • MEDIAN • 0.46 • STD DEV • 0.25 • RANGE • 0.20 IU 1.40 WITH 113 SAMPLES

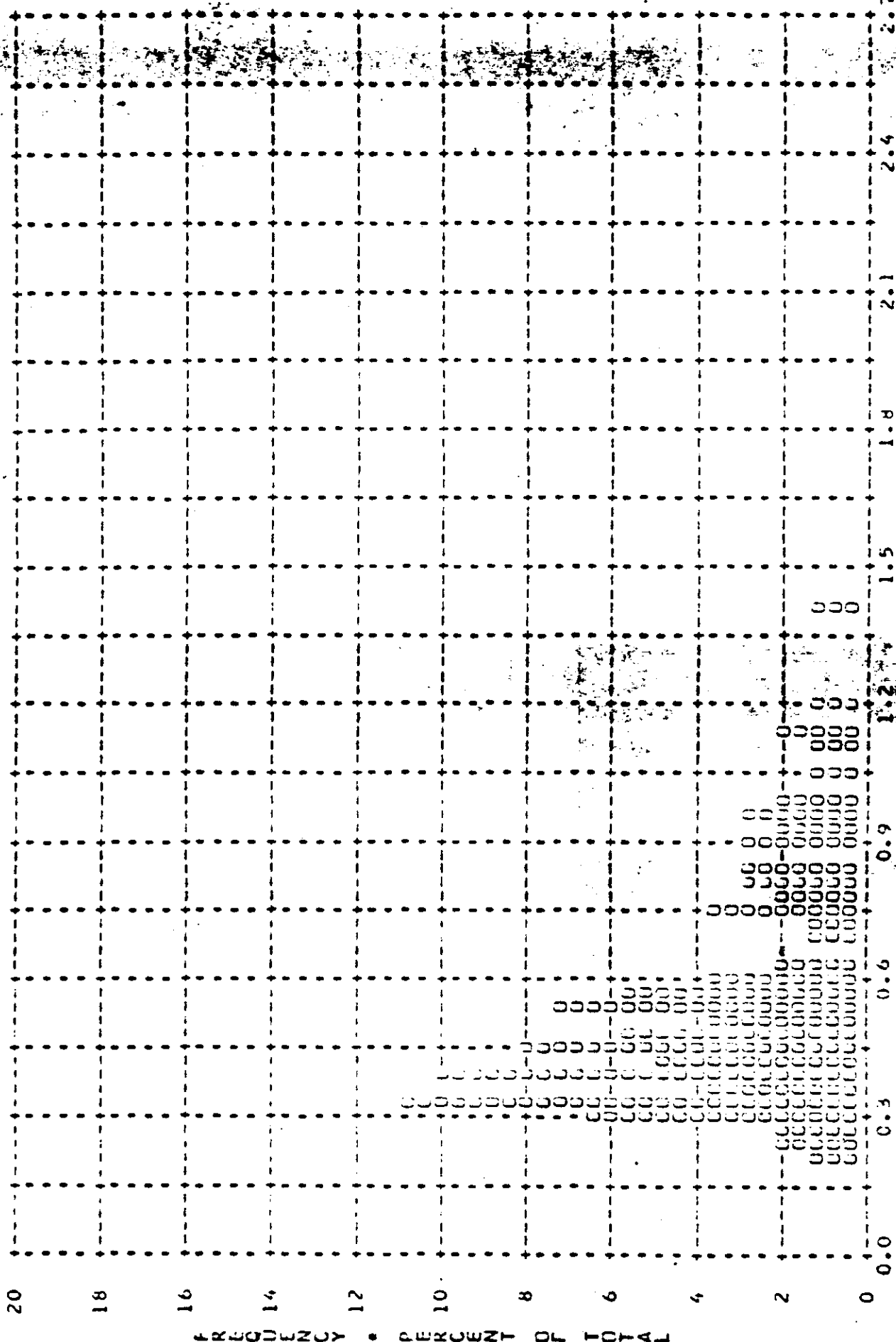

FIGURE 8-10 • DENSITY •

~~TOP SECRET~~

MISSION • 1021-1 • INSTR • AFT • 12-06-65 PLOT OF L MAX • TERRAIN • PROCESSING • INTERMEDIATE  
ARITH MEAN • 1.34 • MEDIA • 1.40 • STD DEV • 0.32 • RANGE • 0.41 TO 1.94 WITH 113 SAMPLES

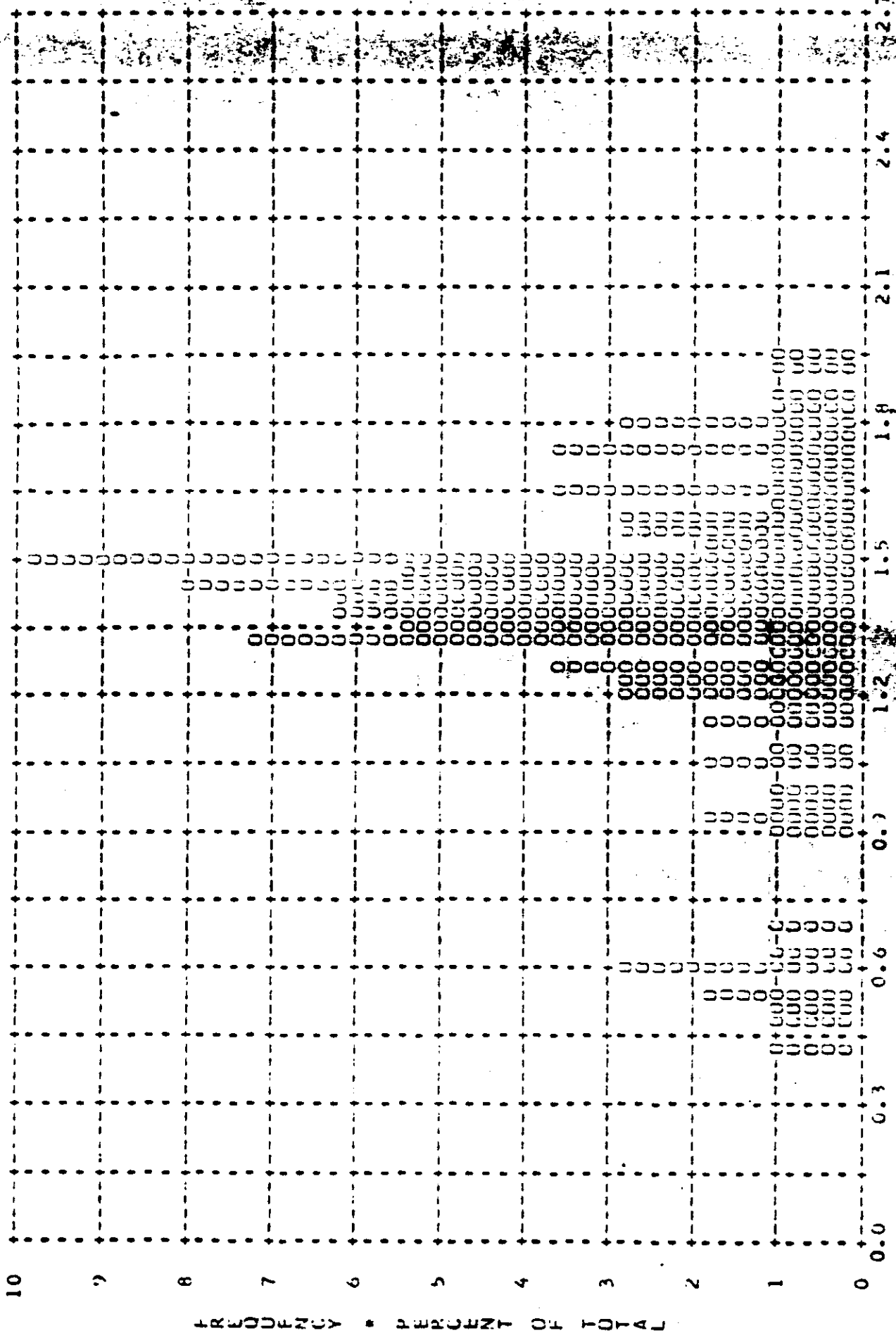

FIGURE 9-11

MISSION • 1073-1 • INSTR • AFT • 12-06-65 PLOT OF D MAX • CLOUD • PROCESSING • INTERMEDIATE  
 ARITH MEAN • 2.13 • RELIAB • 2.10 • STD DEV • 0.17 • RANGE • 1.36 TO 2.37 WITH 103 SAMPLES

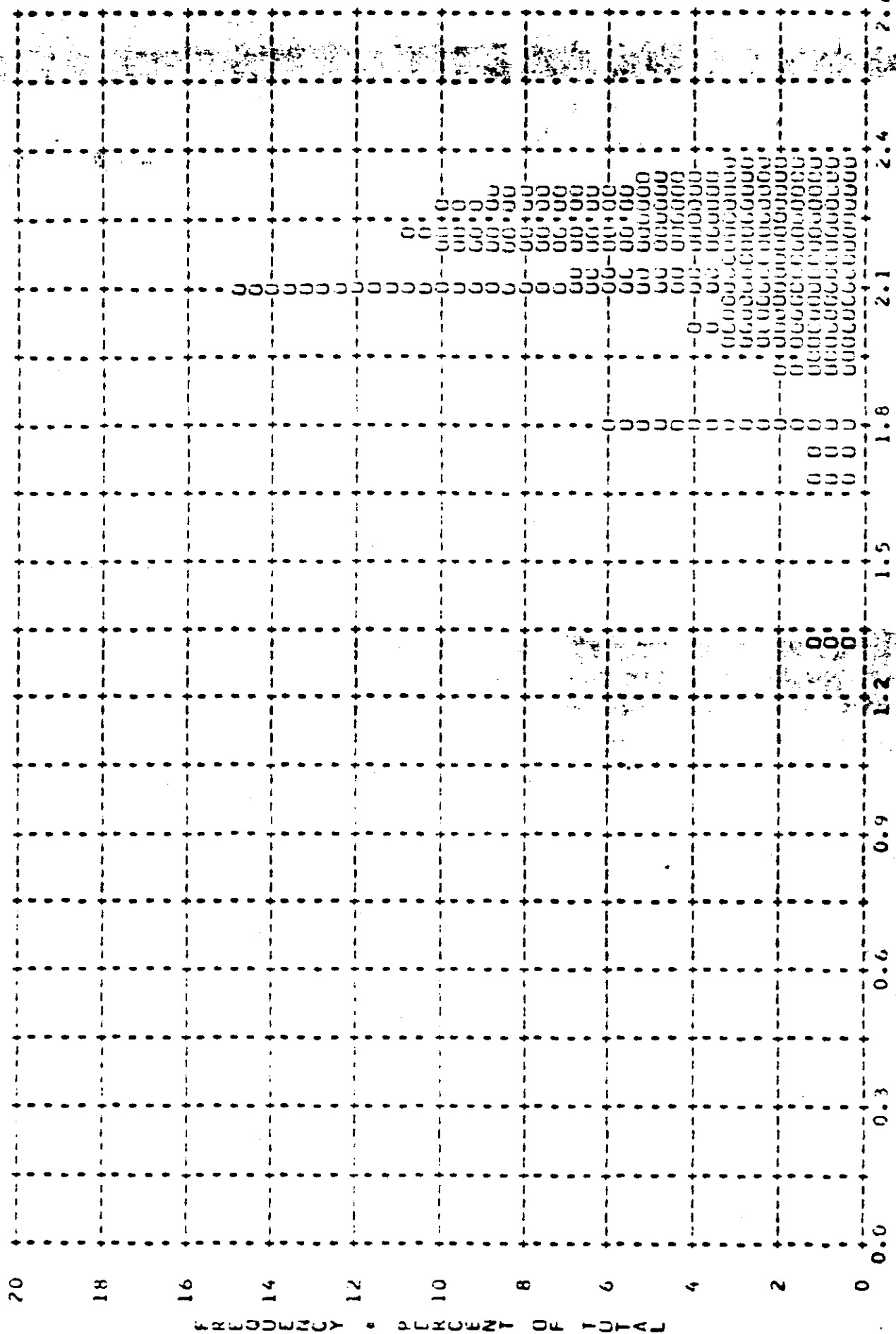

FIGURE 9-12 • DENSITY

MISSION • 1973-1 • IJSTR • AFT • 12-06-65 PLOT OF L MIN • TERRAIN • PROCESSING • FULL  
 ARITH MEAN • 0.52 • MEAN • 0.48 • STD DEV • 0.17 • RANGE • 0.29 TO 1.10 WITH 155 SAMPLES

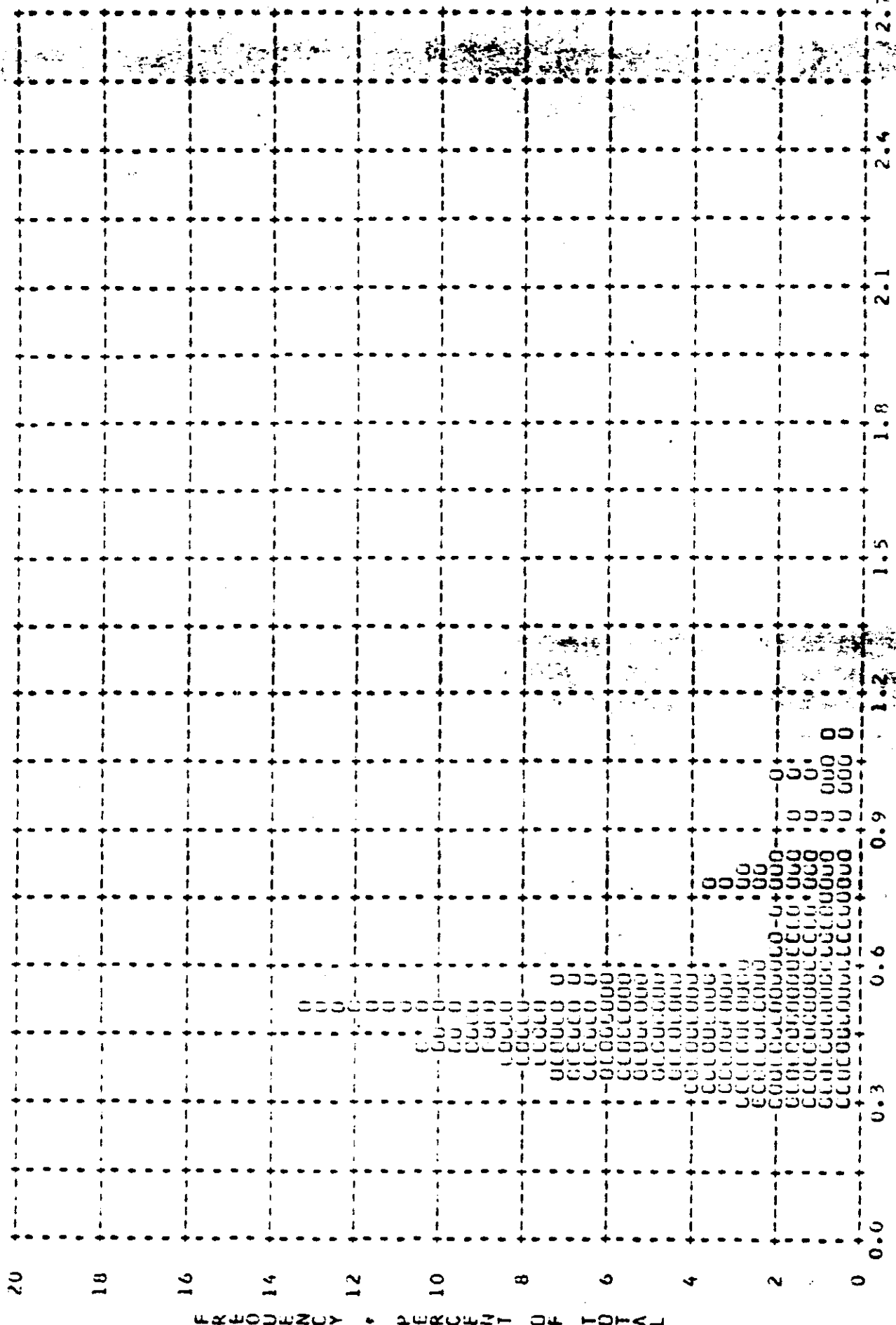

FIGURE 9-13 • DENSITY •

MISSION • 1023-1 • 1/51R • AFT • 12-06-65 PLOT OF D MAX • TERRAIN • PROCESSING • FULL  
 ARITH MEAN • 1.29 • MEDIA • 1.32 • STD DEV • 0.35 • RANGE • 0.42 TO 2.21 WITH 155 SAMPLES

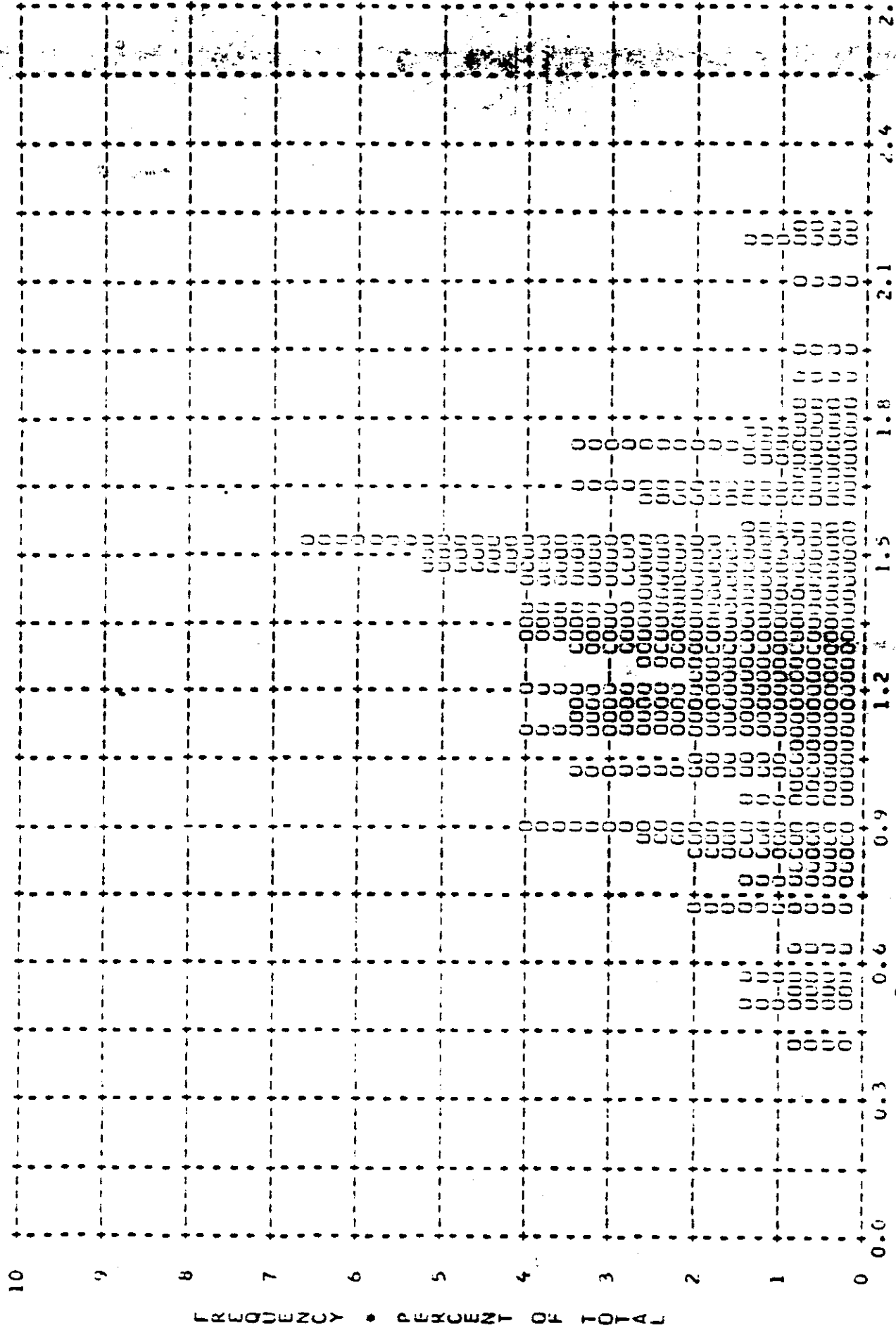

FIGURE 9-14

MISSION • 1023-1 • INSTR • AFT • 12-06-65 PLOT OF O MAX • CLOUD • PROCESSING • FULL  
 ARITH MEAN • 2.16 • MEDIAN • 2.23 • STD DEV • 0.29 • RANGE • 0.18 TO 2.45 WITH 153 SAMPLES

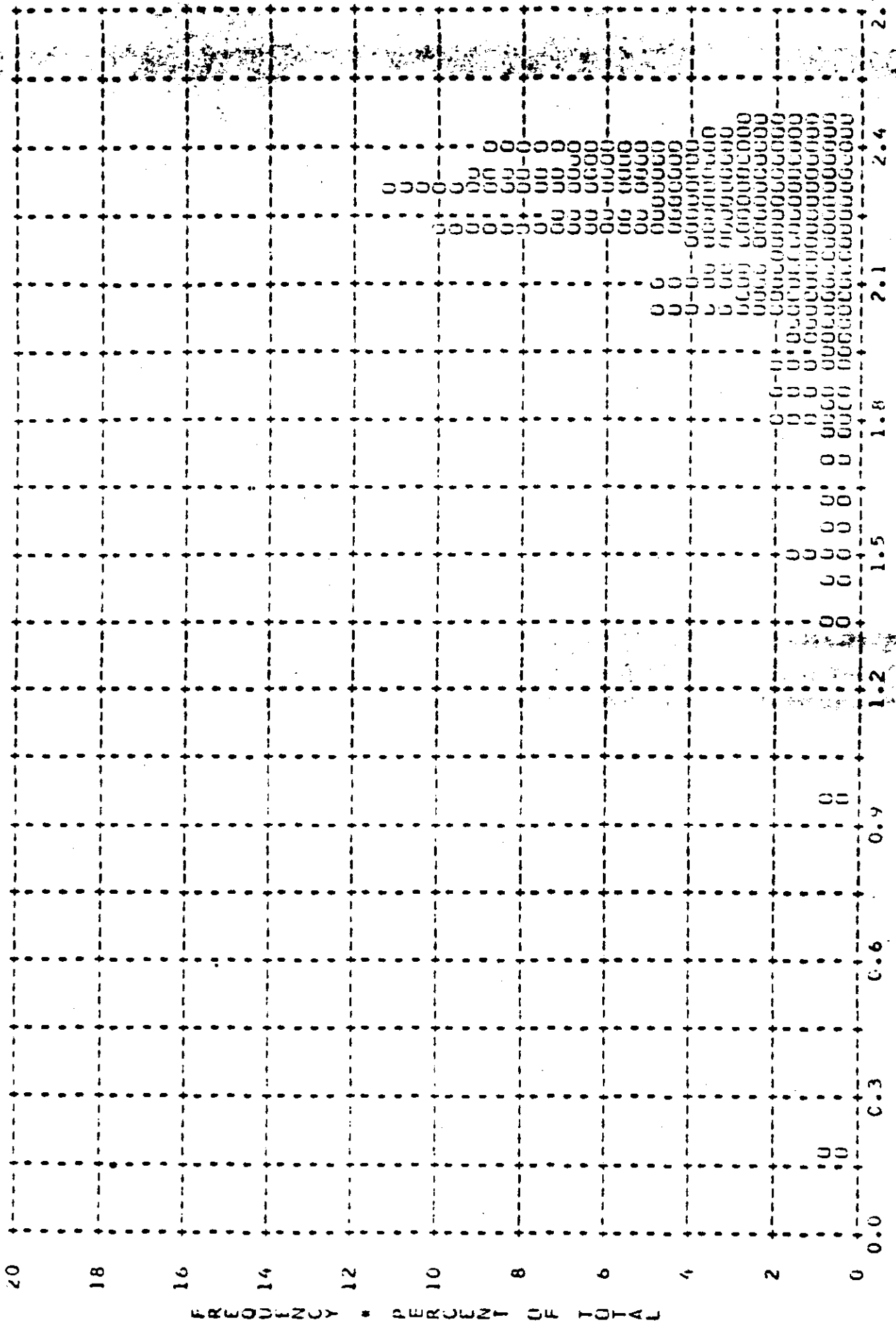

FIGURE 9-15 • DENSITY

MISSION: 1073-1 • TASK: AFI • 12-06-65 PLOT OF U MIN • TERRAIN • PROCESSING • ALL LEVELS  
 ARITH MEAN: 0.53 • MEAN: 0.48 • STD DEV: 0.21 • RANGE: 0.20 TO 1.40 WITH 268 SAMPLES

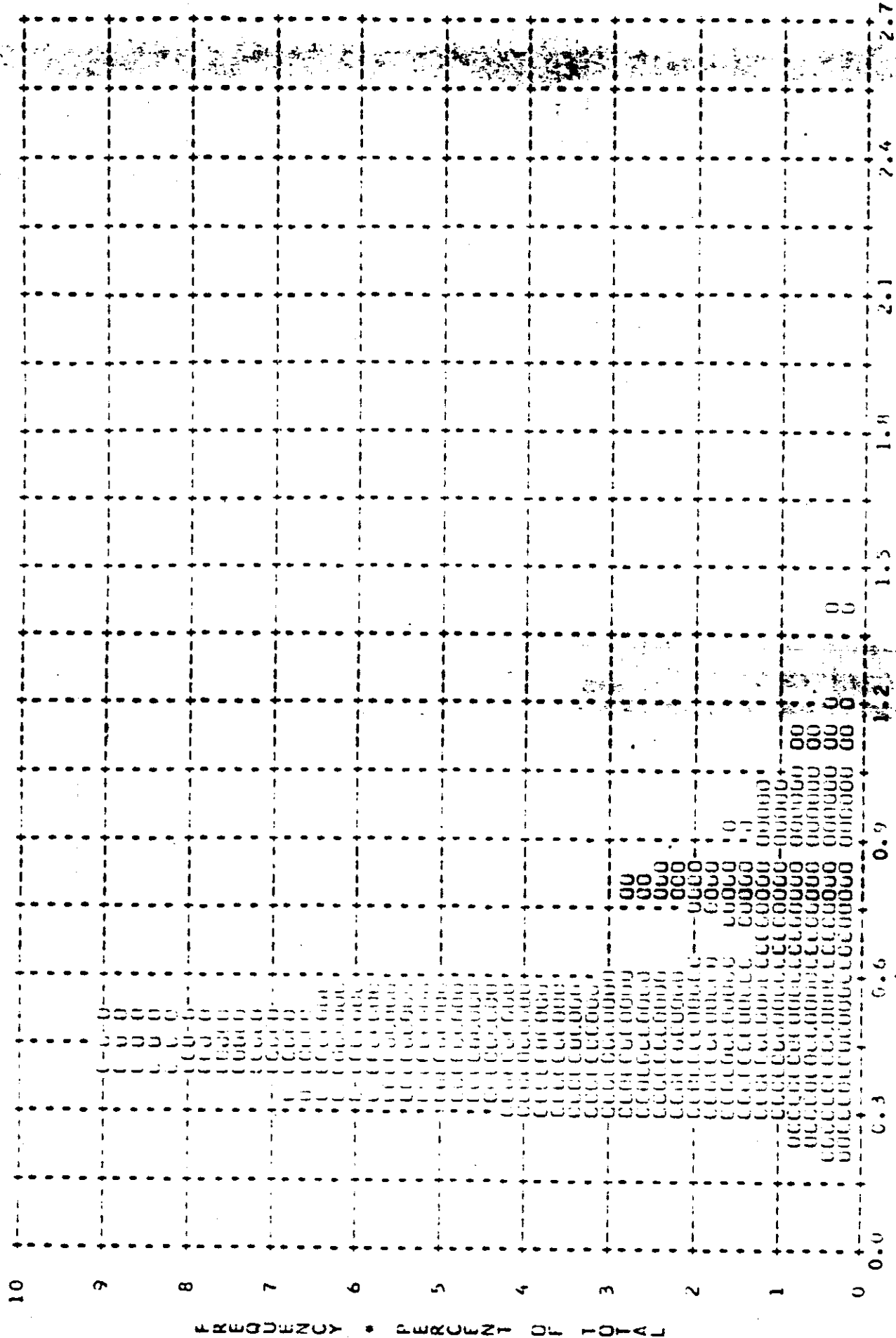

FIGURE 9-16 • DENSITY •



MISSION • 1025 J • INSIR • APT • 12-06-65 PLOT OF U MAC • TERRAIN • PROCESSING • ALL LEVELS  
 ARITH MEAN • 1.51 • MEDIAN • 1.37 • STD DEV • 0.34 • RANGE • 0.41 TO 2.21 WITH 268 SAMPLES

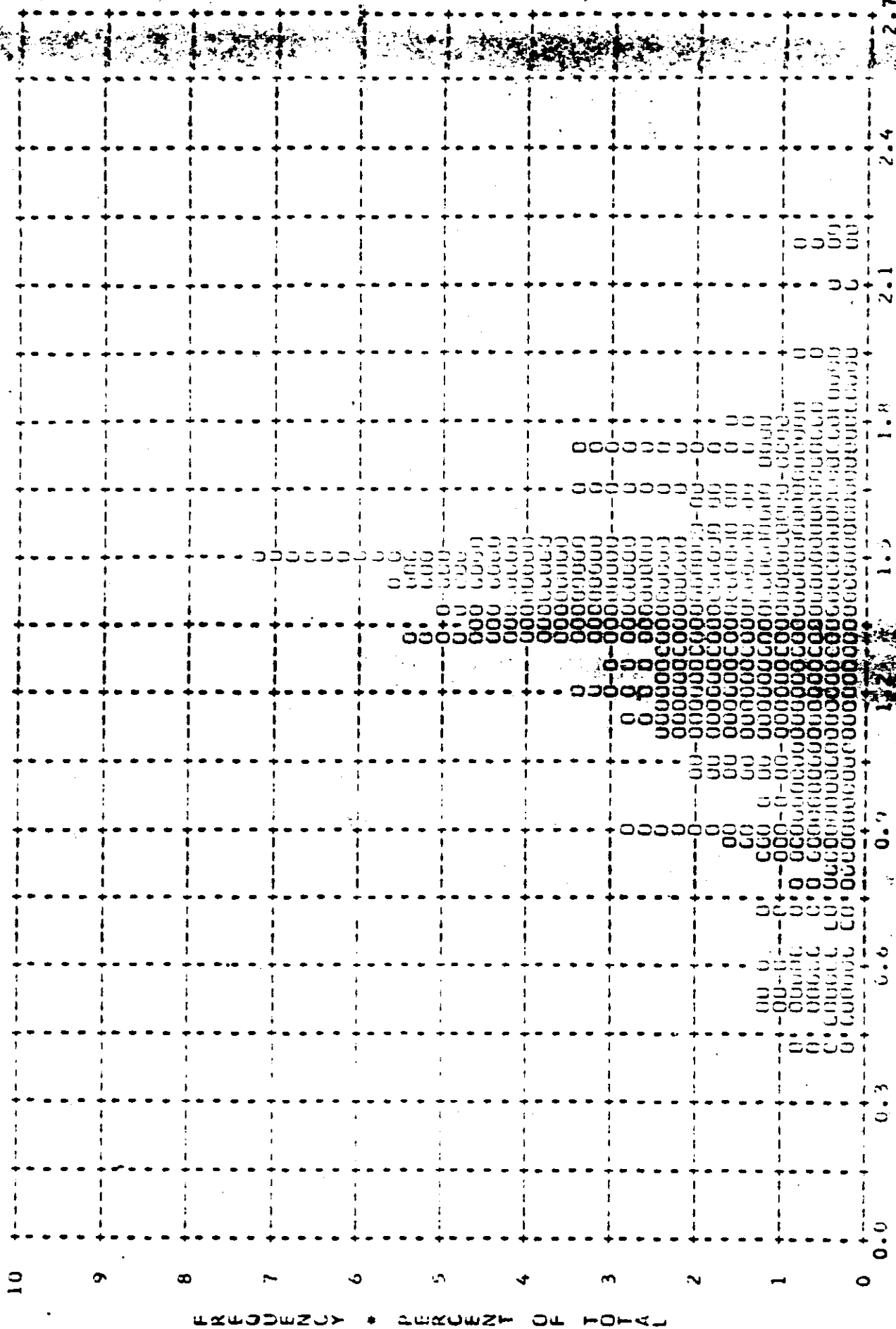

FIGURE 9-17 DENSITY

~~TOP SECRET~~

MISSION • 1023-1 • I/SIR • AFT • 12-06-65 PLOT OF D MAX • CLOUD • PROCESSING • ALL LEVELS  
ARITH MEAN • 2.15 • MEDIAN • 2.20 • SIG. DEV • 0.25 • RANGE • 0.18 TO 2.45 WITH 256 SAMPLES

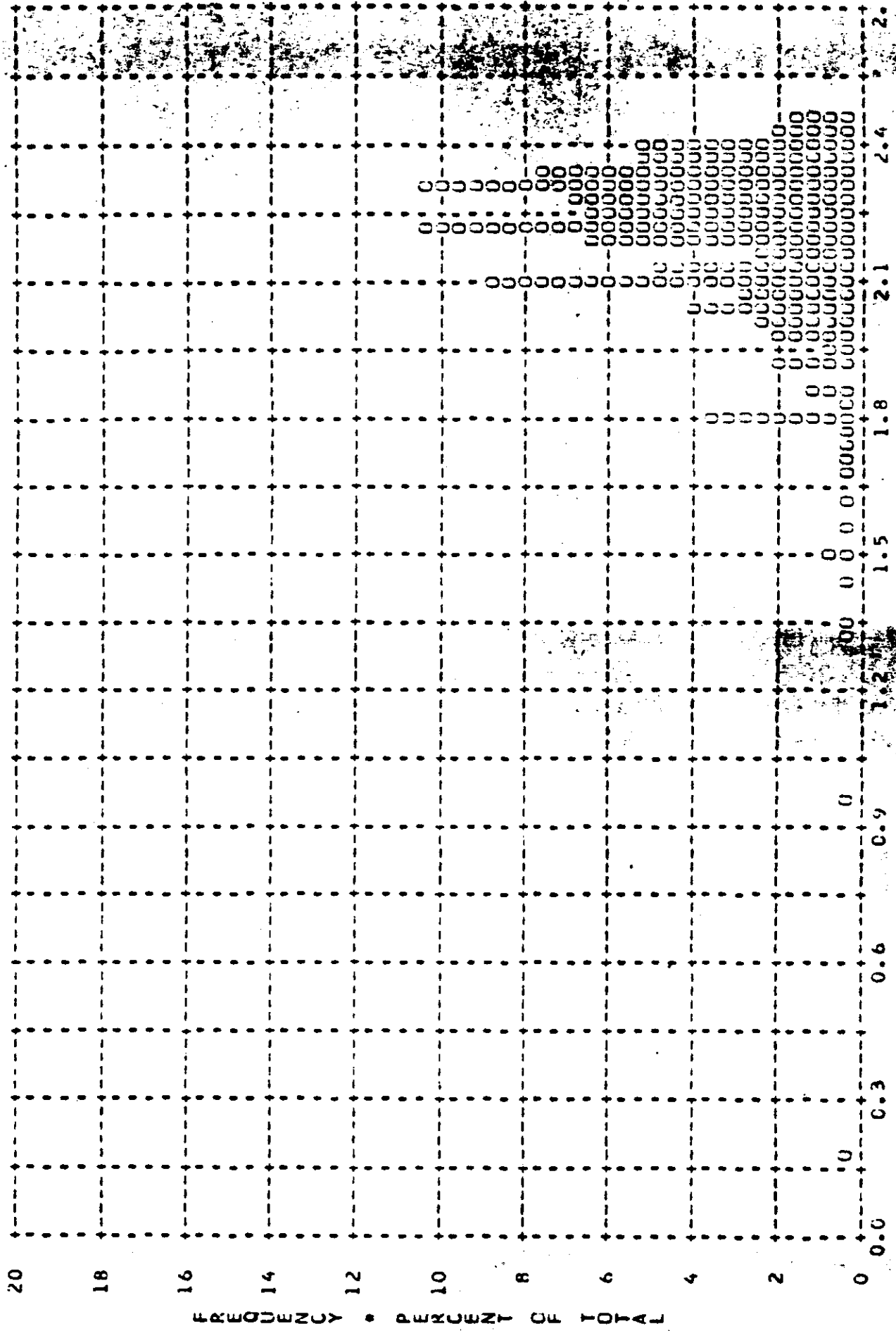

FIGURE 9-18

~~TOP SECRET~~

~~TOP SECRET~~

MISSION • 1023-2 • INSTRUMENT • FRWD • DENSITY FREQ DISTR

DENSITY VALUE	PRIMARY			INTERMEDIATE			ALL LEVELS		
	MIN	MAX	LIM	MIN	MAX	LIM	MIN	MAX	LIM
0.01	0	0	0	0	0	0	0	0	0
0.02	0	0	0	0	0	0	0	0	0
0.03	0	0	0	0	0	0	0	0	0
0.04	0	0	0	0	0	0	0	0	0
0.05	0	0	0	0	0	0	0	0	0
0.06	0	0	0	0	0	0	0	0	0
0.07	0	0	0	0	0	0	0	0	0
0.08	0	0	0	0	0	0	0	0	0
0.09	0	0	0	0	0	0	0	0	0
0.10	0	0	0	0	0	0	0	0	0
0.11	0	0	0	0	0	0	0	0	0
0.12	0	0	0	0	0	0	0	0	0
0.13	0	0	0	0	0	0	0	0	0
0.14	0	0	0	0	0	0	0	0	0
0.15	0	0	0	0	0	0	0	0	0
0.16	0	0	0	0	0	0	0	0	0
0.17	0	0	0	0	0	0	0	0	0
0.18	0	0	0	0	0	0	0	0	0
0.19	0	0	0	0	0	0	0	0	0
0.20	0	0	0	0	0	0	0	0	0
0.21	0	0	0	0	0	0	0	0	0
0.22	0	0	0	0	0	0	0	0	0
0.23	0	0	0	0	0	0	0	0	0
0.24	0	0	0	0	0	0	0	0	0
0.25	0	0	0	0	0	0	0	0	0
0.26	0	0	0	0	0	0	0	0	0
0.27	0	0	0	0	0	0	0	0	0
0.28	0	0	0	0	0	0	0	0	0
0.29	0	0	0	0	0	0	0	0	0
0.30	0	0	0	0	0	0	0	0	0
0.31	0	0	0	0	0	0	0	0	0
0.32	0	0	0	0	0	0	0	0	0
0.33	0	0	0	0	0	0	0	0	0
0.34	0	0	0	0	0	0	0	0	0
0.35	0	0	0	0	0	0	0	0	0
0.36	0	0	0	0	0	0	0	0	0
0.37	0	0	0	0	0	0	0	0	0
0.38	0	0	0	0	0	0	0	0	0
0.39	0	0	0	0	0	0	0	0	0
0.40	0	0	0	0	0	0	0	0	0
0.41	0	0	0	0	0	0	0	0	0
0.42	0	0	0	0	0	0	0	0	0
0.43	0	0	0	0	0	0	0	0	0
0.44	0	0	0	0	0	0	0	0	0
0.45	0	0	0	0	0	0	0	0	0
0.46	0	0	0	0	0	0	0	0	0
0.47	0	0	0	0	0	0	0	0	0
0.48	0	0	0	0	0	0	0	0	0
0.49	0	0	0	0	0	0	0	0	0
0.50	0	0	0	0	0	0	0	0	0
SUBTOTAL	0	0	0	0	0	0	0	0	0

~~TOP SECRET~~

TABLE 9-3

DENSITY VALUE	PRIMARY			INTERMEDIATE			FULL			ALL LEVELS		
	MIN	MAX	LIM	MIN	MAX	LIM	MIN	MAX	LIM	MIN	MAX	LIM
0.51	0	0	0	0	0	0	2	1	0	2	1	0
0.52	0	0	0	0	0	0	0	0	0	0	0	0
0.53	0	0	0	0	0	0	0	0	0	0	0	0
0.54	0	0	0	0	0	0	2	0	0	2	0	0
0.55	0	0	0	0	0	0	2	0	0	2	0	0
0.56	0	0	0	0	0	0	6	0	0	7	0	0
0.57	0	0	0	0	0	0	0	0	0	0	0	0
0.58	0	0	0	0	0	0	0	0	0	0	0	0
0.59	0	0	0	0	0	0	0	0	0	0	0	0
0.60	0	0	0	0	0	0	0	0	0	0	0	0
0.61	0	0	0	0	0	0	0	0	0	0	0	0
0.62	0	0	0	0	0	0	0	0	0	0	0	0
0.63	0	0	0	0	0	0	0	0	0	0	0	0
0.64	0	0	0	0	0	0	0	0	0	0	0	0
0.65	0	0	0	0	0	0	0	0	0	0	0	0
0.66	0	0	0	0	0	0	0	0	0	0	0	0
0.67	0	0	0	0	0	0	0	0	0	0	0	0
0.68	0	0	0	0	0	0	0	0	0	0	0	0
0.69	0	0	0	0	0	0	0	0	0	0	0	0
0.70	0	0	0	0	0	0	0	0	0	0	0	0
0.71	0	0	0	0	0	0	0	0	0	0	0	0
0.72	0	0	0	0	0	0	0	0	0	0	0	0
0.73	0	0	0	0	0	0	0	0	0	0	0	0
0.74	0	0	0	0	0	0	0	0	0	0	0	0
0.75	0	0	0	0	0	0	0	0	0	0	0	0
0.76	0	0	0	0	0	0	0	0	0	0	0	0
0.77	0	0	0	0	0	0	0	0	0	0	0	0
0.78	0	0	0	0	0	0	0	0	0	0	0	0
0.79	0	0	0	0	0	0	0	0	0	0	0	0
0.80	0	0	0	0	0	0	0	0	0	0	0	0
0.81	0	0	0	0	0	0	0	0	0	0	0	0
0.82	0	0	0	0	0	0	0	0	0	0	0	0
0.83	0	0	0	0	0	0	0	0	0	0	0	0
0.84	0	0	0	0	0	0	0	0	0	0	0	0
0.85	0	0	0	0	0	0	0	0	0	0	0	0
0.86	0	0	0	0	0	0	0	0	0	0	0	0
0.87	0	0	0	0	0	0	0	0	0	0	0	0
0.88	0	0	0	0	0	0	0	0	0	0	0	0
0.89	0	0	0	0	0	0	0	0	0	0	0	0
0.90	0	0	0	0	0	0	0	0	0	0	0	0
0.91	0	0	0	0	0	0	0	0	0	0	0	0
0.92	0	0	0	0	0	0	0	0	0	0	0	0
0.93	0	0	0	0	0	0	0	0	0	0	0	0
0.94	0	0	0	0	0	0	0	0	0	0	0	0
0.95	0	0	0	0	0	0	0	0	0	0	0	0
0.96	0	0	0	0	0	0	0	0	0	0	0	0
0.97	0	0	0	0	0	0	0	0	0	0	0	0
0.98	0	0	0	0	0	0	0	0	0	0	0	0
0.99	0	0	0	0	0	0	0	0	0	0	0	0
1.00	0	0	0	0	0	0	0	0	0	0	0	0
SUBTOTAL	0	0	0	14	1	0	21	43	2	35	44	2

TABLE 9-3

DENSITY VALUE	PRIMARY		INTERMEDIATE			FULL			ALL LEVELS			
	MIN	MAX	LIM	MIN	MAX	LIM	MIN	MAX	LIM	MIN	MAX	LIM
1.01	0	0	0	0	0	0	0	0	0	0	0	0
1.02	0	0	0	0	0	0	0	0	0	0	0	0
1.03	0	0	0	0	0	0	0	0	0	0	0	0
1.04	0	0	0	0	0	0	0	0	0	0	0	0
1.05	0	0	0	0	0	0	0	0	0	0	0	0
1.06	0	0	0	0	0	0	0	0	0	0	0	0
1.07	0	0	0	0	0	0	0	0	0	0	0	0
1.08	0	0	0	0	0	0	0	0	0	0	0	0
1.09	0	0	0	0	0	0	0	0	0	0	0	0
1.10	0	0	0	0	0	0	0	0	0	0	0	0
1.11	0	0	0	0	0	0	0	0	0	0	0	0
1.12	0	0	0	0	0	0	0	0	0	0	0	0
1.13	0	0	0	0	0	0	0	0	0	0	0	0
1.14	0	0	0	0	0	0	0	0	0	0	0	0
1.15	0	0	0	0	0	0	0	0	0	0	0	0
1.16	0	0	0	0	0	0	0	0	0	0	0	0
1.17	0	0	0	0	0	0	0	0	0	0	0	0
1.18	0	0	0	0	0	0	0	0	0	0	0	0
1.19	0	0	0	0	0	0	0	0	0	0	0	0
1.20	0	0	0	0	0	0	0	0	0	0	0	0
1.21	0	0	0	0	0	0	0	0	0	0	0	0
1.22	0	0	0	0	0	0	0	0	0	0	0	0
1.23	0	0	0	0	0	0	0	0	0	0	0	0
1.24	0	0	0	0	0	0	0	0	0	0	0	0
1.25	0	0	0	0	0	0	0	0	0	0	0	0
1.26	0	0	0	0	0	0	0	0	0	0	0	0
1.27	0	0	0	0	0	0	0	0	0	0	0	0
1.28	0	0	0	0	0	0	0	0	0	0	0	0
1.29	0	0	0	0	0	0	0	0	0	0	0	0
1.30	0	0	0	0	0	0	0	0	0	0	0	0
1.31	0	0	0	0	0	0	0	0	0	0	0	0
1.32	0	0	0	0	0	0	0	0	0	0	0	0
1.33	0	0	0	0	0	0	0	0	0	0	0	0
1.34	0	0	0	0	0	0	0	0	0	0	0	0
1.35	0	0	0	0	0	0	0	0	0	0	0	0
1.36	0	0	0	0	0	0	0	0	0	0	0	0
1.37	0	0	0	0	0	0	0	0	0	0	0	0
1.38	0	0	0	0	0	0	0	0	0	0	0	0
1.39	0	0	0	0	0	0	0	0	0	0	0	0
1.40	0	0	0	0	0	0	0	0	0	0	0	0
1.41	0	0	0	0	0	0	0	0	0	0	0	0
1.42	0	0	0	0	0	0	0	0	0	0	0	0
1.43	0	0	0	0	0	0	0	0	0	0	0	0
1.44	0	0	0	0	0	0	0	0	0	0	0	0
1.45	0	0	0	0	0	0	0	0	0	0	0	0
1.46	0	0	0	0	0	0	0	0	0	0	0	0
1.47	0	0	0	0	0	0	0	0	0	0	0	0
1.48	0	0	0	0	0	0	0	0	0	0	0	0
1.49	0	0	0	0	0	0	0	0	0	0	0	0
1.50	0	0	0	0	0	0	0	0	0	0	0	0
SUBTOTAL	0	0	0	2	13	0	1	4	2	2	3	5

TABLE 9-3

~~TOP SECRET~~

MISSION • 1023-2 • INSTRUMENT • FRWD 12-06-65 DENSITY FREQ DISTR

DENSITY VALUE	PRIMARY			INTERMEDIATE			FULL			ALL LEVELS		
	MIN	MAX	LIM	MIN	MAX	LIM	MIN	MAX	LIM	MIN	MAX	LIM
1.51	0	0	0	0	1	0	0	0	2	0	1	2
1.52	0	0	0	0	0	0	0	0	0	0	0	0
1.53	0	0	0	0	0	0	0	0	0	0	0	0
1.54	0	0	0	0	0	0	0	0	0	0	0	0
1.55	0	0	0	0	0	0	0	0	0	0	0	0
1.56	0	0	0	0	0	0	0	0	0	0	0	0
1.57	0	0	0	0	0	0	0	0	0	0	0	0
1.58	0	0	0	0	0	0	0	0	0	0	0	0
1.59	0	0	0	0	0	0	0	0	0	0	0	0
1.60	0	0	0	0	0	0	0	0	0	0	0	0
1.61	0	0	0	0	0	0	0	0	0	0	0	0
1.62	0	0	0	0	0	0	0	0	0	0	0	0
1.63	0	0	0	0	0	0	0	0	0	0	0	0
1.64	0	0	0	0	0	0	0	0	0	0	0	0
1.65	0	0	0	0	0	0	0	0	0	0	0	0
1.66	0	0	0	0	0	0	0	0	0	0	0	0
1.67	0	0	0	0	0	0	0	0	0	0	0	0
1.68	0	0	0	0	0	0	0	0	0	0	0	0
1.69	0	0	0	0	0	0	0	0	0	0	0	0
1.70	0	0	0	0	0	0	0	0	0	0	0	0
1.71	0	0	0	0	0	0	0	0	0	0	0	0
1.72	0	0	0	0	0	0	0	0	0	0	0	0
1.73	0	0	0	0	0	0	0	0	0	0	0	0
1.74	0	0	0	0	0	0	0	0	0	0	0	0
1.75	0	0	0	0	0	0	0	0	0	0	0	0
1.76	0	0	0	0	0	0	0	0	0	0	0	0
1.77	0	0	0	0	0	0	0	0	0	0	0	0
1.78	0	0	0	0	0	0	0	0	0	0	0	0
1.79	0	0	0	0	0	0	0	0	0	0	0	0
1.80	0	0	0	0	0	0	0	0	0	0	0	0
1.81	0	0	0	0	0	0	0	0	0	0	0	0
1.82	0	0	0	0	0	0	0	0	0	0	0	0
1.83	0	0	0	0	0	0	0	0	0	0	0	0
1.84	0	0	0	0	0	0	0	0	0	0	0	0
1.85	0	0	0	0	0	0	0	0	0	0	0	0
1.86	0	0	0	0	0	0	0	0	0	0	0	0
1.87	0	0	0	0	0	0	0	0	0	0	0	0
1.88	0	0	0	0	0	0	0	0	0	0	0	0
1.89	0	0	0	0	0	0	0	0	0	0	0	0
1.90	0	0	0	0	0	0	0	0	0	0	0	0
1.91	0	0	0	0	0	0	0	0	0	0	0	0
1.92	0	0	0	0	0	0	0	0	0	0	0	0
1.93	0	0	0	0	0	0	0	0	0	0	0	0
1.94	0	0	0	0	0	0	0	0	0	0	0	0
1.95	0	0	0	0	0	0	0	0	0	0	0	0
1.96	0	0	0	0	0	0	0	0	0	0	0	0
1.97	0	0	0	0	0	0	0	0	0	0	0	0
1.98	0	0	0	0	0	0	0	0	0	0	0	0
1.99	0	0	0	0	0	0	0	0	0	0	0	0
2.00	0	0	0	0	0	0	0	0	0	0	0	0
SUBTOTAL	0	0	0	0	5	6	0	20	28	0	29	34

~~TOP SECRET~~

TABLE 9-3

DENSITY VALUE	PRIMARY			INTERMEDIATE			FULL			ALL LEVELS		
	MIN	MAX	LIM	MIN	MAX	LIM	MIN	MAX	LIM	MIN	MAX	LIM
2.01	0	0	0	0	0	0	0	0	0	0	0	0
2.02	0	0	0	0	0	0	0	0	0	0	0	0
2.03	0	0	0	0	0	0	0	0	0	0	0	0
2.04	0	0	0	0	0	0	0	0	0	0	0	0
2.05	0	0	0	0	0	0	0	0	0	0	0	0
2.06	0	0	0	0	0	0	0	0	0	0	0	0
2.07	0	0	0	0	0	0	0	0	0	0	0	0
2.08	0	0	0	0	0	0	0	0	0	0	0	0
2.09	0	0	0	0	0	0	0	0	0	0	0	0
2.10	0	0	0	0	0	0	0	0	0	0	0	0
2.11	0	0	0	0	0	0	0	0	0	0	0	0
2.12	0	0	0	0	0	0	0	0	0	0	0	0
2.13	0	0	0	0	0	0	0	0	0	0	0	0
2.14	0	0	0	0	0	0	0	0	0	0	0	0
2.15	0	0	0	0	0	0	0	0	0	0	0	0
2.16	0	0	0	0	0	0	0	0	0	0	0	0
2.17	0	0	0	0	0	0	0	0	0	0	0	0
2.18	0	0	0	0	0	0	0	0	0	0	0	0
2.19	0	0	0	0	0	0	0	0	0	0	0	0
2.20	0	0	0	0	0	0	0	0	0	0	0	0
2.21	0	0	0	0	0	0	0	0	0	0	0	0
2.22	0	0	0	0	0	0	0	0	0	0	0	0
2.23	0	0	0	0	0	0	0	0	0	0	0	0
2.24	0	0	0	0	0	0	0	0	0	0	0	0
2.25	0	0	0	0	0	0	0	0	0	0	0	0
2.26	0	0	0	0	0	0	0	0	0	0	0	0
2.27	0	0	0	0	0	0	0	0	0	0	0	0
2.28	0	0	0	0	0	0	0	0	0	0	0	0
2.29	0	0	0	0	0	0	0	0	0	0	0	0
2.30	0	0	0	0	0	0	0	0	0	0	0	0
2.31	0	0	0	0	0	0	0	0	0	0	0	0
2.32	0	0	0	0	0	0	0	0	0	0	0	0
2.33	0	0	0	0	0	0	0	0	0	0	0	0
2.34	0	0	0	0	0	0	0	0	0	0	0	0
2.35	0	0	0	0	0	0	0	0	0	0	0	0
2.36	0	0	0	0	0	0	0	0	0	0	0	0
2.37	0	0	0	0	0	0	0	0	0	0	0	0
2.38	0	0	0	0	0	0	0	0	0	0	0	0
2.39	0	0	0	0	0	0	0	0	0	0	0	0
2.40	0	0	0	0	0	0	0	0	0	0	0	0
2.41	0	0	0	0	0	0	0	0	0	0	0	0
2.42	0	0	0	0	0	0	0	0	0	0	0	0
2.43	0	0	0	0	0	0	0	0	0	0	0	0
2.44	0	0	0	0	0	0	0	0	0	0	0	0
2.45	0	0	0	0	0	0	0	0	0	0	0	0
2.46	0	0	0	0	0	0	0	0	0	0	0	0
2.47	0	0	0	0	0	0	0	0	0	0	0	0
2.48	0	0	0	0	0	0	0	0	0	0	0	0
2.49	0	0	0	0	0	0	0	0	0	0	0	0
2.50	0	0	0	0	0	0	0	0	0	0	0	0
SUBTOTAL						13			67			80

~~TOP SECRET~~

TABLE 9-3

~~TOP SECRET~~

MISSION • 1023-2 • INSTRUMENT • FRWD 12-06-65 DENSITY FREQ DISTR

DENSITY VALUE	PRIMARY			INTERMEDIATE			FULL			ALL LEVELS		
	MIN	MAX	LIM	MIN	MAX	LIM	MIN	MAX	LIM	MIN	MAX	LIM
2.51	0	0	0	0	0	0	0	0	0	0	0	0
2.52	0	0	0	0	0	0	0	0	0	0	0	0
2.53	0	0	0	0	0	0	0	0	0	0	0	0
2.54	0	0	0	0	0	0	0	0	0	0	0	0
2.55	0	0	0	0	0	0	0	0	0	0	0	0
2.56	0	0	0	0	0	0	0	0	0	0	0	0
2.57	0	0	0	0	0	0	0	0	0	0	0	0
2.58	0	0	0	0	0	0	0	0	0	0	0	0
2.59	0	0	0	0	0	0	0	0	0	0	0	0
2.60	0	0	0	0	0	0	0	0	0	0	0	0
2.61	0	0	0	0	0	0	0	0	0	0	0	0
2.62	0	0	0	0	0	0	0	0	0	0	0	0
2.63	0	0	0	0	0	0	0	0	0	0	0	0
2.64	0	0	0	0	0	0	0	0	0	0	0	0
2.65	0	0	0	0	0	0	0	0	0	0	0	0
2.66	0	0	0	0	0	0	0	0	0	0	0	0
2.67	0	0	0	0	0	0	0	0	0	0	0	0
2.68	0	0	0	0	0	0	0	0	0	0	0	0
2.69	0	0	0	0	0	0	0	0	0	0	0	0
2.70	0	0	0	0	0	0	0	0	0	0	0	0
SUBTOTAL	0	0	0	0	0	0	0	0	0	0	0	0
TOTAL	0	0	0	24	24	19	111	111	99	135	135	118

MISSION 1023-2 INSTR - FRWD 12-06-65 PROCESSING AND EXPOSURE ANALYS

PROCESS LEVEL	SAMPLE SIZE	UNDER EXPOSED	UNDER PROCESSED	CURRENT EXP+PROC	OVER PROCESSED	OVER EXPOSED
PRIMARY	0	0 PC	0 PC	0 PC	0 PC	0 PC
INTERMEDIATE	24	0 PC	13 PC	75 PC	8 PC	4 PC
FULL	111	42 PC	0 PC	57 PC	1 PC	0 PC
ALL LEVELS	135	35 PC	2 PC	60 PC	2 PC	1 PC

PROCESS LEVEL	BASE + FCG	UNDER EXPOSED	UNDER PROCESSED	CURRENT EXP+PROC	OVER PROCESSED	OVER EXPOSED
PRIMARY	0.01-0.09	0.01-0.13	0.14-0.39	0.40-0.90	-----	0.91 AND U
INTERMED	0.10-0.17	0.01-0.20	0.21-0.39	0.40-0.90	0.91-1.34	1.35 AND U
FULL	0.18 AND UP	0.01-0.39	-----	0.40-0.90	0.91-1.69	1.70 AND U

~~TOP SECRET~~

TABLE 9-3



~~TOP SECRET~~

MISSION • 1023-2 • INSTR • FRWD • 12-06-65 PLOT OF D MIN • TERRAIN • PROCESSING • INTERMEDIATE  
ARITH MEAN • 0.68 • MEDIA I • 0.61 • STD DEV • 0.27 • RANGE • 0.32 TO 1.38 WITH 24 SAMPLES

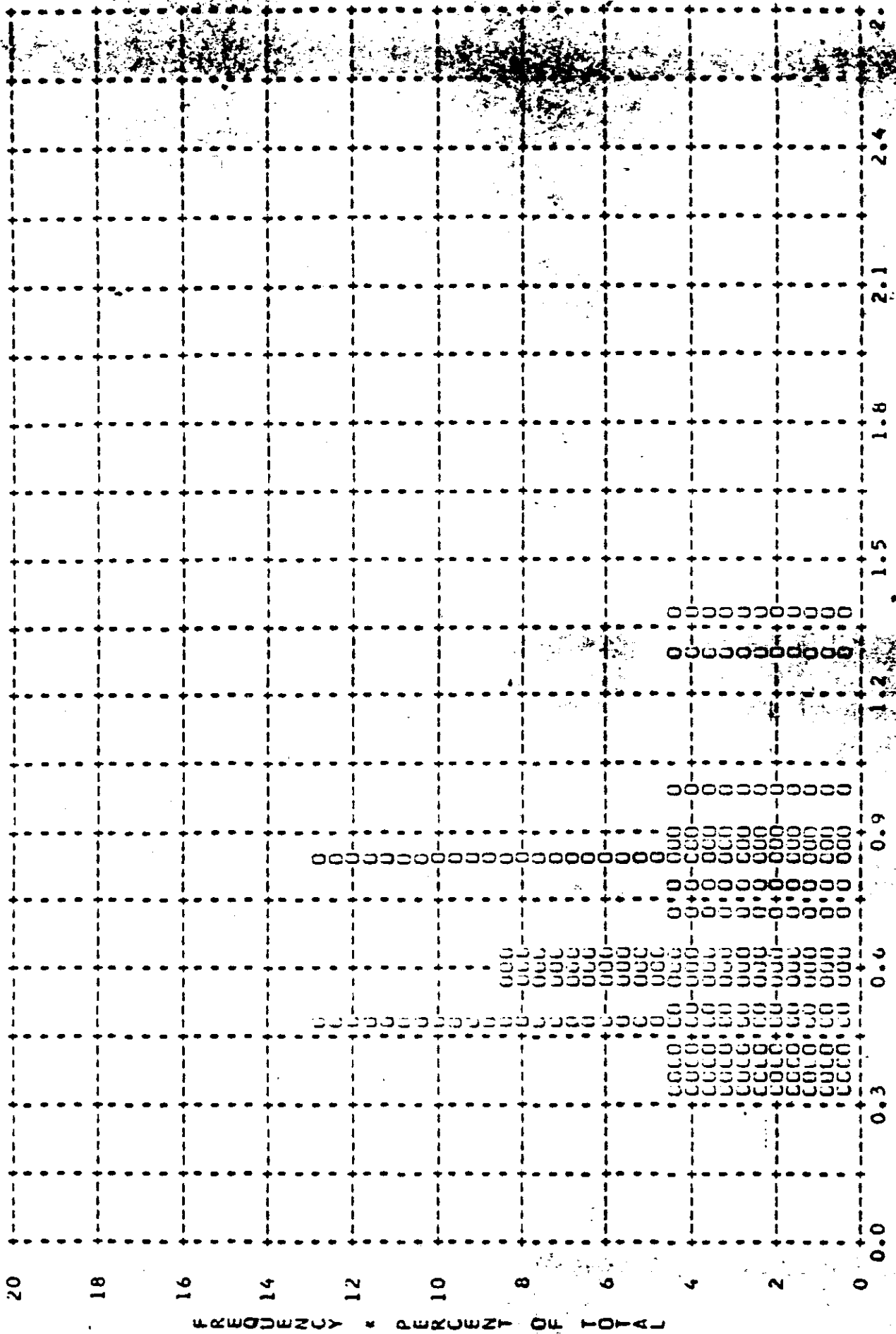

FIGURE 9-19

~~TOP SECRET~~

MISSION • 1023-2 • INSTR • FRWD • 12-06-65 PLOT OF D MAX • TERRAIN • PROCESSING • INTERMEDIATE  
ARITH MLAN • 1.44 • MEDIAN • 1.46 • STD DEV • 0.32 • RANGE • 0.48 TO 1.90 WITH 24 SAMPLES

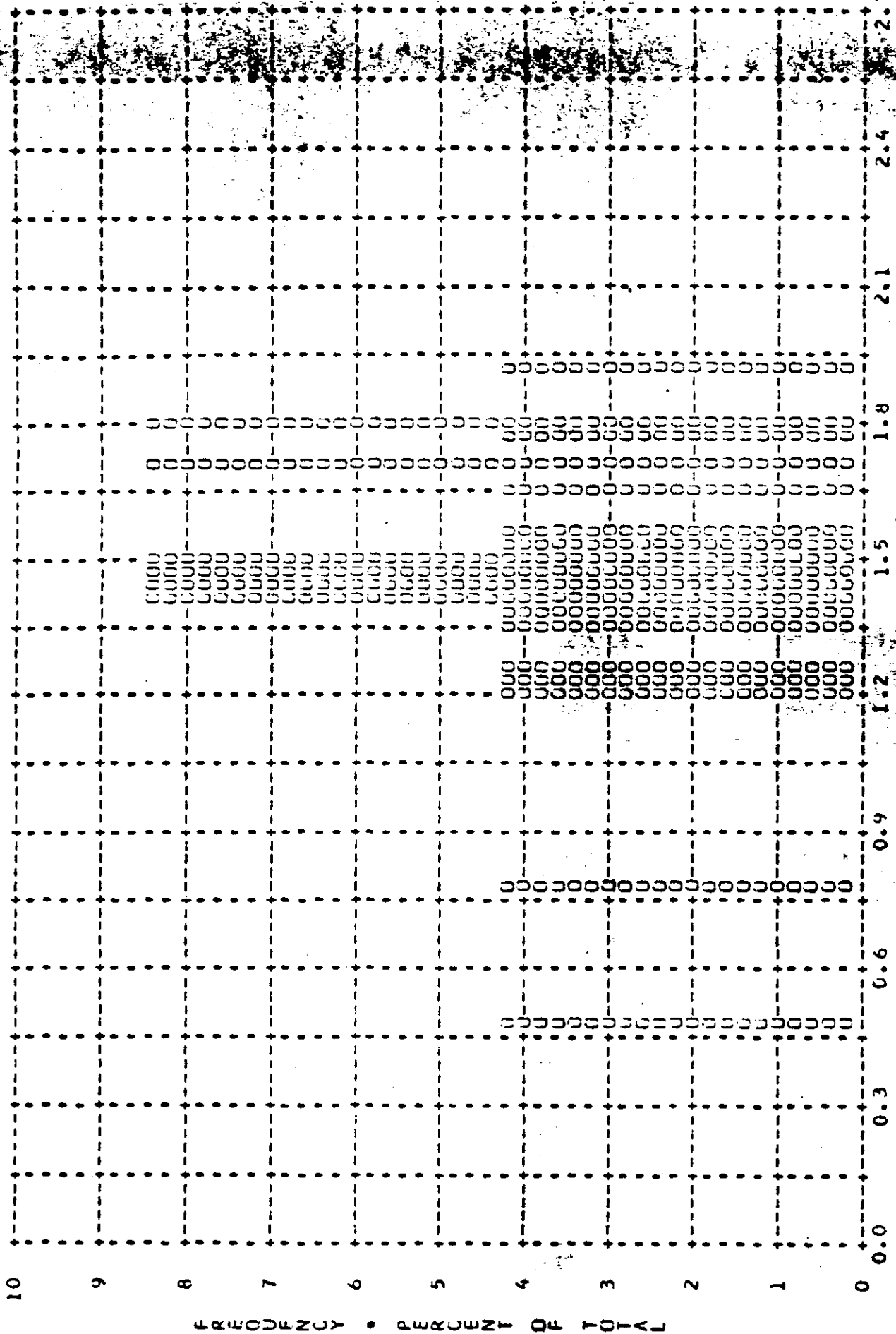

FIGURE 9-20 • DENSITY

~~TOP SECRET~~

MISSION • 1023-2 • INSTR • FRWD • 12-06-65 PLOT OF D MAX • CLOUD • PROCESSING • INTERMEDIATE  
ARITH MEAN • 2.04 • MEDIAN • 2.11 • STD DEV • 0.20 • RANGE • 1.52 TO 2.31 WITH 19 SAMPLES

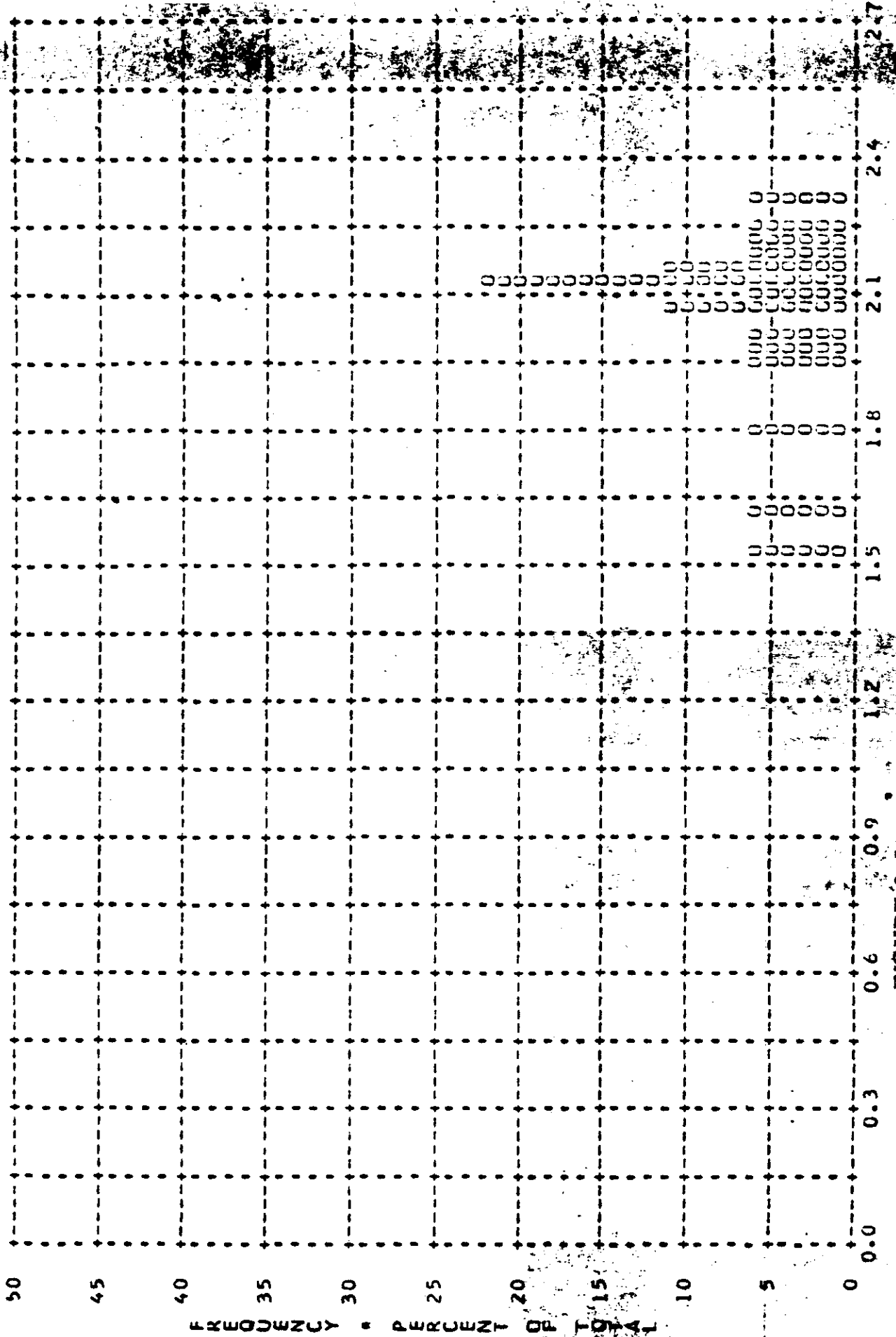

FIGURE 9-21 DENSITY

~~TOP SECRET~~

MISSION • 1023-2 • INSTR • FRWD • 12-06-65 PLOT OF U MIN • TERRAIN • PROCESSING • FULL  
ARITH MEAN • 0.43 • MEDIAN • 0.40 • STD DEV • 0.15 • RANGE • 0.22 TO 1.20 WITH 111 SAMPLES

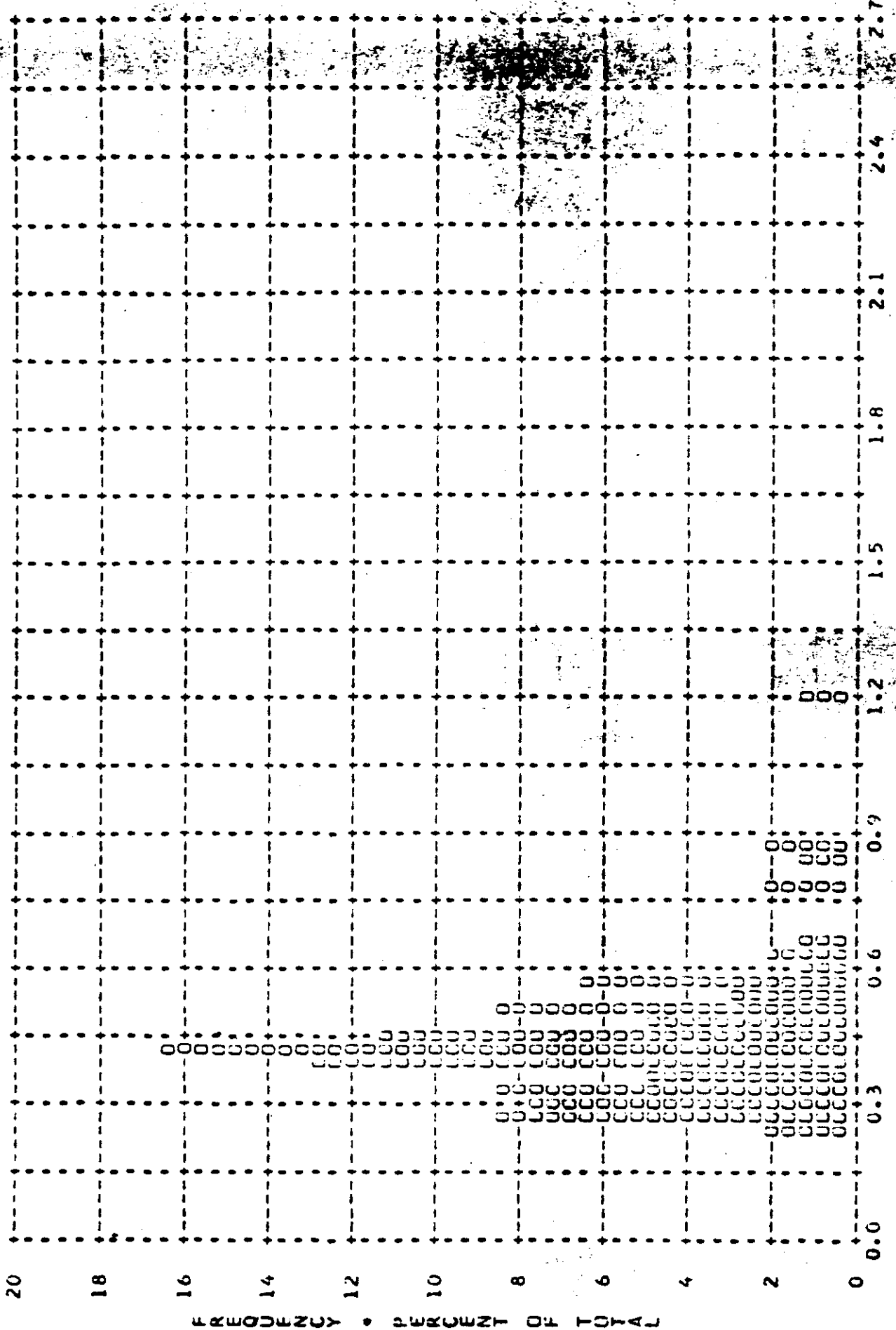

FIGURE 9-22 • DENSITY

~~TOP SECRET~~

MISSION • 1023-2 • INSTR • FRWD • 12-06-65 PLOT OF D MAX • TERRAIN • PROCESSING • FULL  
ARITH MEAN • 1.12 • MEDIAN • 1.11 • STD DEV • 0.38 • RANGE • 0.41 TO 2.03 WITH 111 SAMPLES

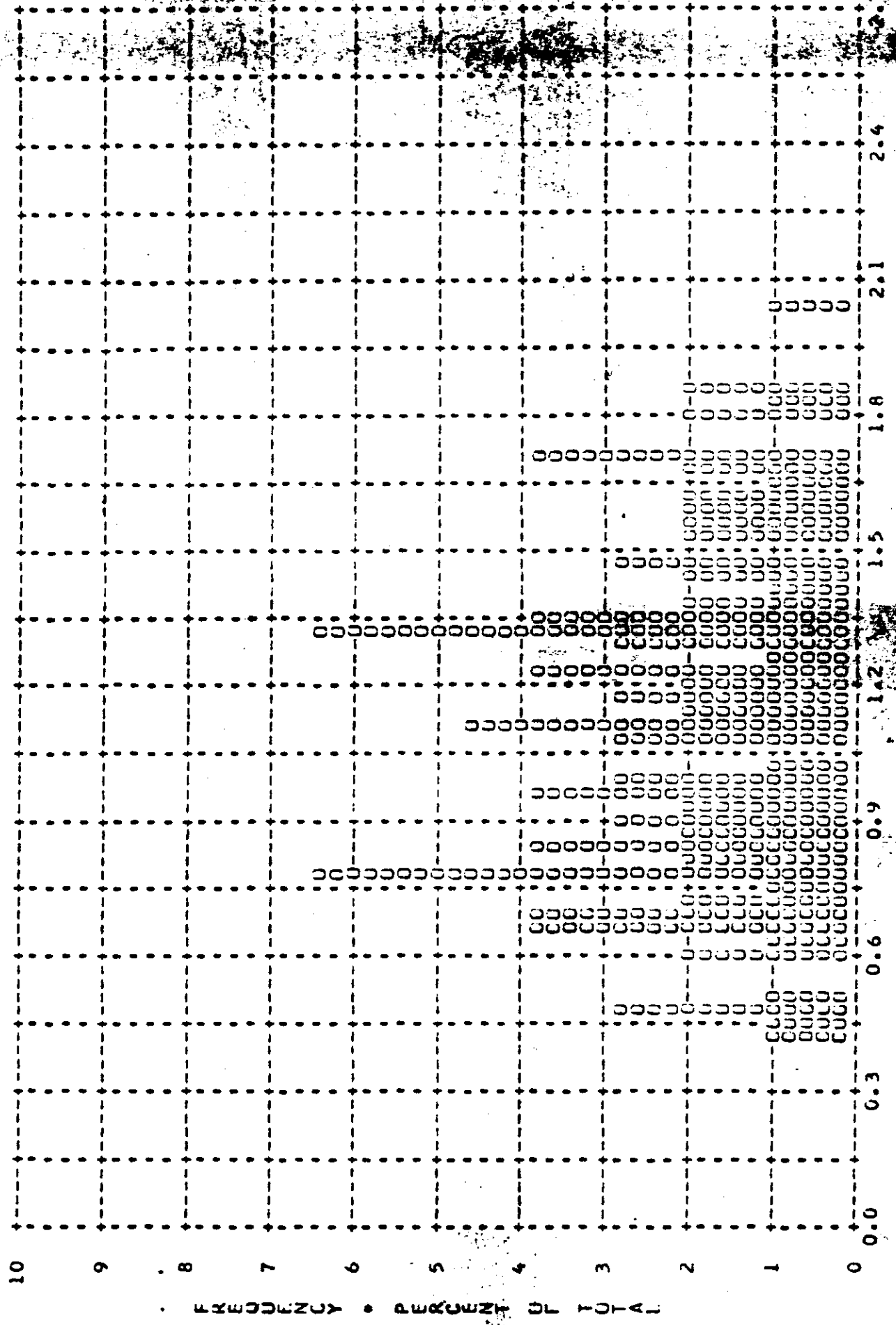

FIGURE 9-23

SECRET

MISSION • 1023-2 • INSIR • FRWD • 12-06-65 PLOT OF U MAX • CLOUD • PROCESSING • FULL  
ARITH MEAN • 2.03 • MEDIAN • 2.11 • STD DEV • 0.27 • RANGE • 0.90 TO 2.41 WITH 99 SAMPLES

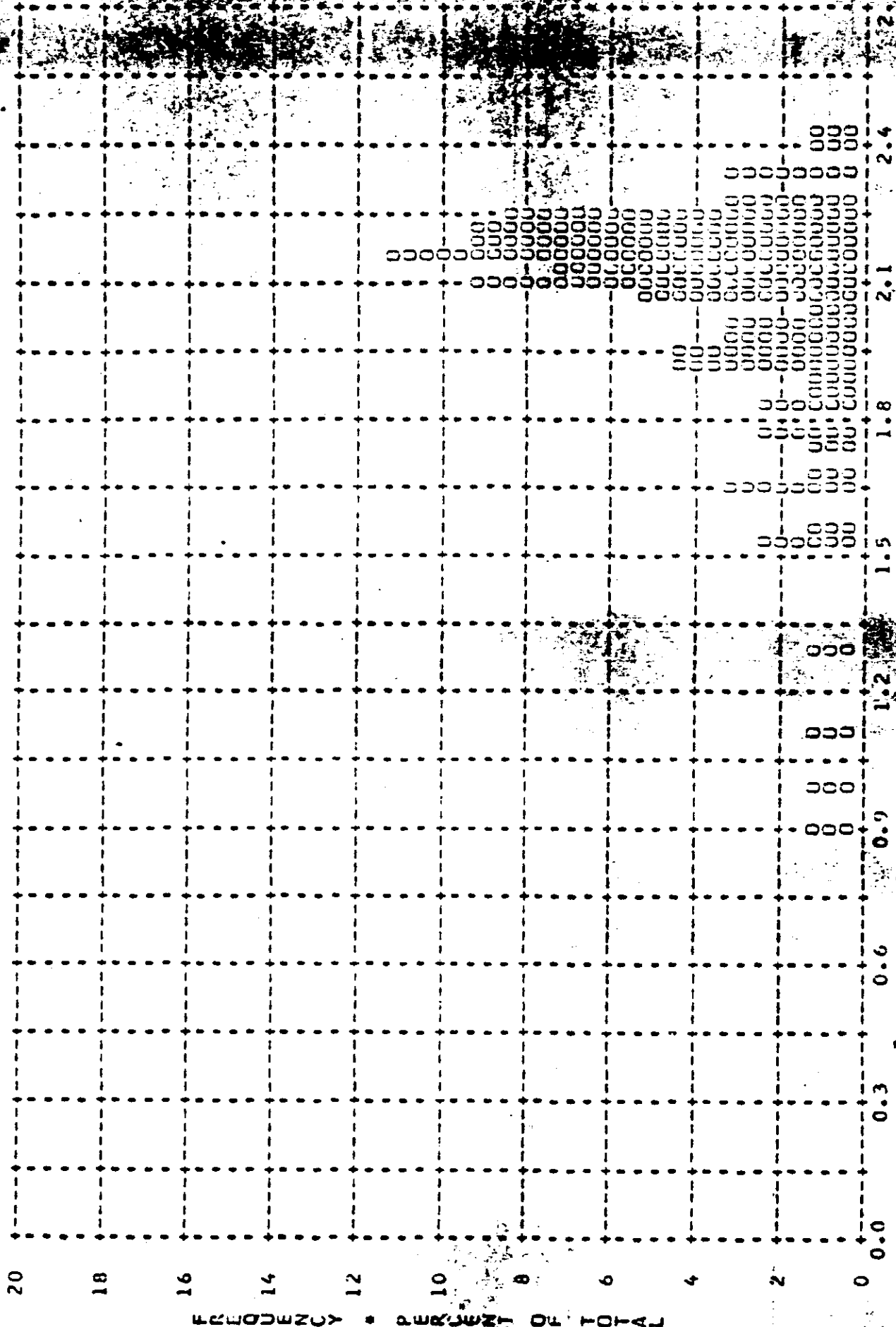

FIGURE 9-24

MISSION • 1023-2 • INSTR • FRWD • 12-06-65 PLOT OF D MIN • TERRAIN • PROCESSING • ALL LEVELS  
ARITH MEAN • 0.48 • MEDIAN • 0.42 • STD DEV • 0.20 • RANGE • 0.22 TO 1.38 WITH 135 SAMPLES

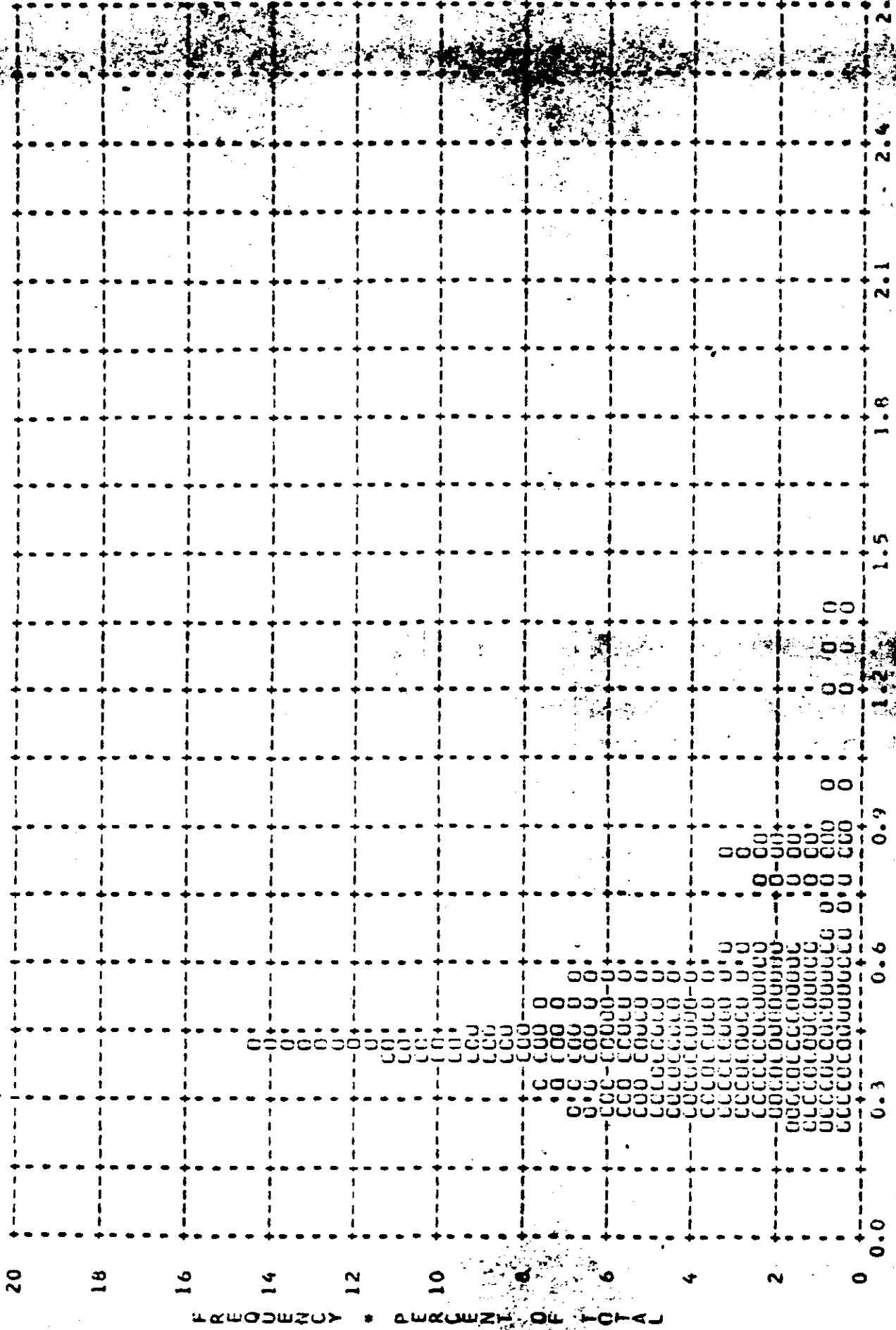

FIGURE 9-25

~~TOP SECRET~~

MISSION • 1023-2 • INSIR • IRWD • 12-06-65 PLOT OF D MAX • TERRAIN • PROCESSING • ALL LEVELS  
ARITH MEAN • 1.18 • MEDIAN • 1.22 • STD DEV • 0.39 • RANGE • 0.41 TO 2.03 WITH 135 SAMPLES

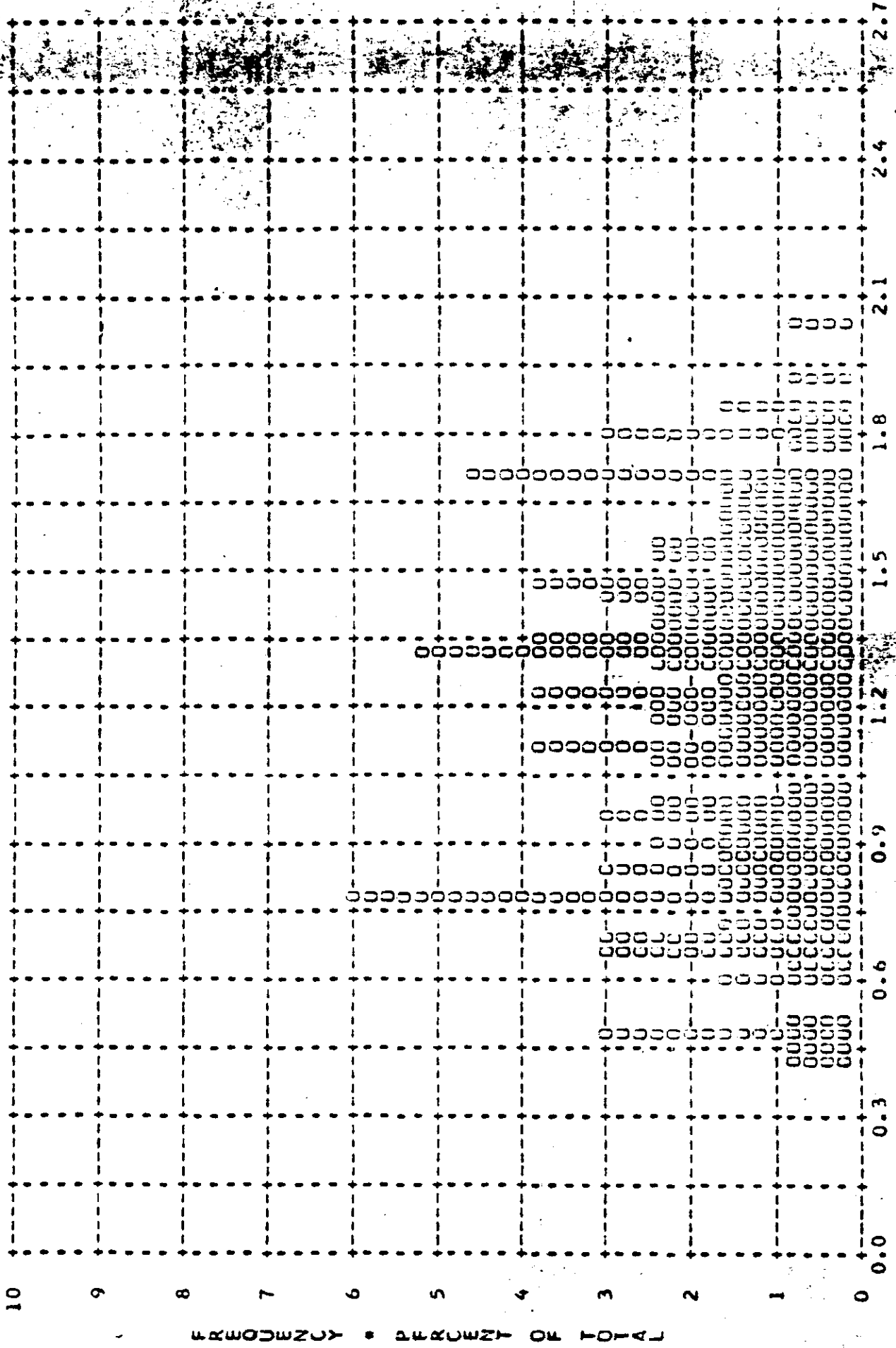

FIGURE 9-26 • DENSITY



MISSION • 1023-2 • INSTR • FRWD • 12-06-65 PLOT OF 0 MAX • CLOUD • PRUCESING • ALL LEVELS  
 ARITH MEAN • 2.03 • MEDIAN • 2.11 • STD DEV • 0.26 • RANGE • 0.90 TU 2.41 WITH 118 SAMPLES

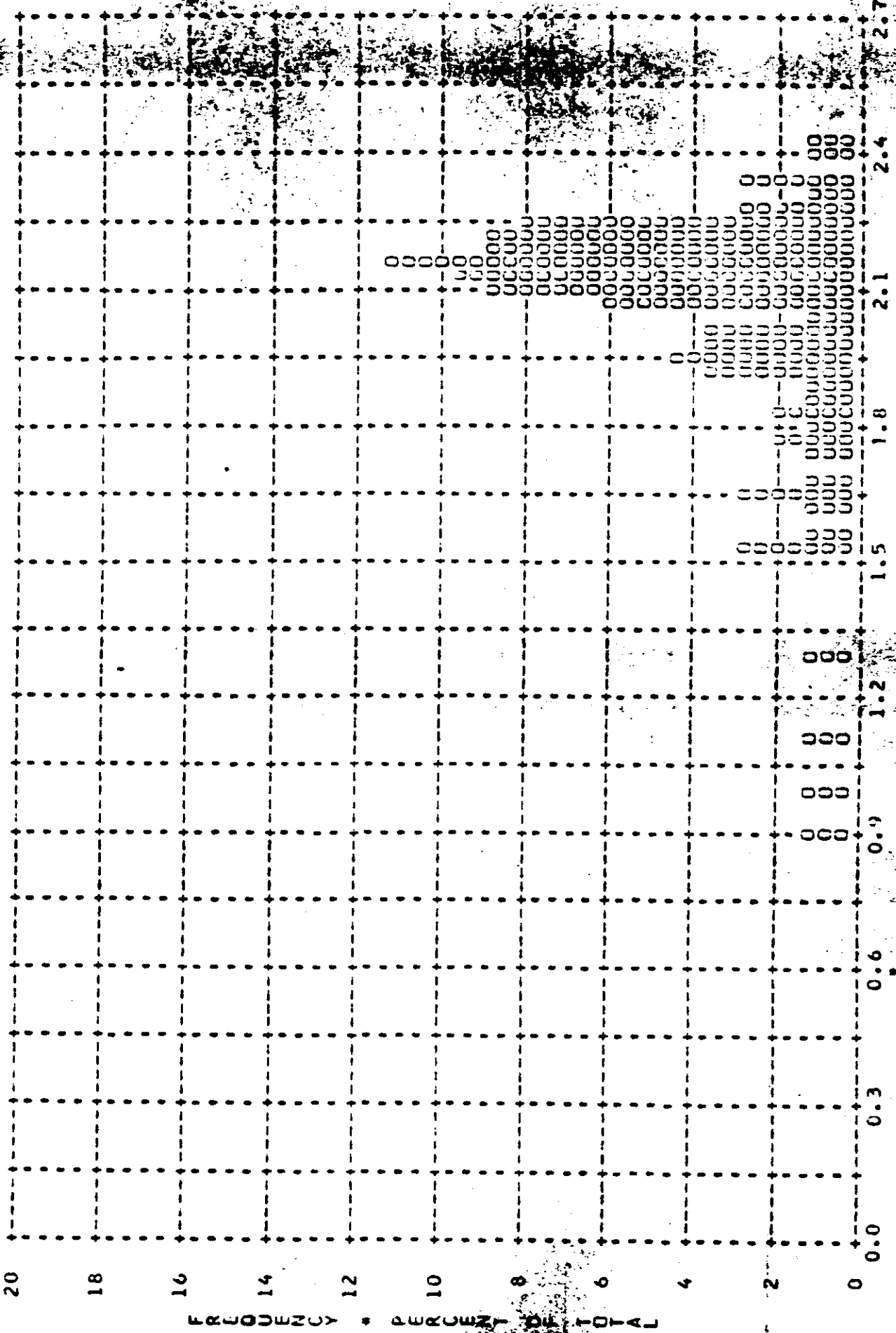

FIGURE 9-27

DENSITY VALUE	PRIMARY			INTERMEDIATE			FULL			ALL LEVELS		
	MIN	MAX	LIM	MIN	MAX	LIM	MIN	MAX	LIM	MIN	MAX	LIM
00.01	0	0	0	0	0	0	0	0	0	0	0	0
00.02	0	0	0	0	0	0	0	0	0	0	0	0
00.03	0	0	0	0	0	0	0	0	0	0	0	0
00.04	0	0	0	0	0	0	0	0	0	0	0	0
00.05	0	0	0	0	0	0	0	0	0	0	0	0
00.06	0	0	0	0	0	0	0	0	0	0	0	0
00.07	0	0	0	0	0	0	0	0	0	0	0	0
00.08	0	0	0	0	0	0	0	0	0	0	0	0
00.09	0	0	0	0	0	0	0	0	0	0	0	0
00.10	0	0	0	0	0	0	0	0	0	0	0	0
00.11	0	0	0	0	0	0	0	0	0	0	0	0
00.12	0	0	0	0	0	0	0	0	0	0	0	0
00.13	0	0	0	0	0	0	0	0	0	0	0	0
00.14	0	0	0	0	0	0	0	0	0	0	0	0
00.15	0	0	0	0	0	0	0	0	0	0	0	0
00.16	0	0	0	0	0	0	0	0	0	0	0	0
00.17	0	0	0	0	0	0	0	0	0	0	0	0
00.18	0	0	0	0	0	0	0	0	0	0	0	0
00.19	0	0	0	0	0	0	0	0	0	0	0	0
00.20	0	0	0	0	0	0	0	0	0	0	0	0
00.21	0	0	0	0	0	0	0	0	0	0	0	0
00.22	0	0	0	0	0	0	0	0	0	0	0	0
00.23	0	0	0	0	0	0	0	0	0	0	0	0
00.24	0	0	0	0	0	0	0	0	0	0	0	0
00.25	0	0	0	0	0	0	0	0	0	0	0	0
00.26	0	0	0	0	0	0	0	0	0	0	0	0
00.27	0	0	0	0	0	0	0	0	0	0	0	0
00.28	0	0	0	0	0	0	0	0	0	0	0	0
00.29	0	0	0	0	0	0	0	0	0	0	0	0
00.30	0	0	0	0	0	0	0	0	0	0	0	0
00.31	0	0	0	0	0	0	0	0	0	0	0	0
00.32	0	0	0	0	0	0	0	0	0	0	0	0
00.33	0	0	0	0	0	0	0	0	0	0	0	0
00.34	0	0	0	0	0	0	0	0	0	0	0	0
00.35	0	0	0	0	0	0	0	0	0	0	0	0
00.36	0	0	0	0	0	0	0	0	0	0	0	0
00.37	0	0	0	0	0	0	0	0	0	0	0	0
00.38	0	0	0	0	0	0	0	0	0	0	0	0
00.39	0	0	0	0	0	0	0	0	0	0	0	0
00.40	0	0	0	0	0	0	0	0	0	0	0	0
00.41	0	0	0	0	0	0	0	0	0	0	0	0
00.42	0	0	0	0	0	0	0	0	0	0	0	0
00.43	0	0	0	0	0	0	0	0	0	0	0	0
00.44	0	0	0	0	0	0	0	0	0	0	0	0
00.45	0	0	0	0	0	0	0	0	0	0	0	0
00.46	0	0	0	0	0	0	0	0	0	0	0	0
00.47	0	0	0	0	0	0	0	0	0	0	0	0
00.48	0	0	0	0	0	0	0	0	0	0	0	0
00.49	0	0	0	0	0	0	0	0	0	0	0	0
00.50	0	0	0	0	0	0	0	0	0	0	0	0
SUBTOTAL	0	0	0	4	10	10	110	1	0	155	0	0

TABLE 9-4

~~TOP SECRET~~

MISSION • 1023-2 • INSTRUMENT • AFT 12-06-65 DENSITY FREQ DISTR

DENSITY VALUE	PRIMARY			INTERMEDIATE			FULL			ALL LEVELS		
	MIN	MAX	LIM	MIN	MAX	LIM	MIN	MAX	LIM	MIN	MAX	LIM
0.51	0	0	0	1	0	0	3	1	0	4	1	0
0.52	0	0	0	3	0	0	13	4	0	16	4	0
0.53	0	0	0	0	0	0	3	0	0	3	0	0
0.54	0	0	0	0	0	0	4	1	0	4	1	0
0.55	0	0	0	0	1	0	4	1	0	4	1	0
0.56	0	0	0	0	1	0	3	1	0	4	1	0
0.57	0	0	0	0	0	0	6	0	0	6	0	0
0.58	0	0	0	0	0	0	5	0	0	5	0	0
0.59	0	0	0	0	0	0	7	0	0	8	0	0
0.60	0	0	0	0	0	0	0	0	0	0	0	0
0.61	0	0	0	0	0	0	0	0	0	0	0	0
0.62	0	0	0	0	0	0	3	0	0	3	0	0
0.63	0	0	0	0	0	0	1	0	0	1	0	0
0.64	0	0	0	0	0	0	1	0	0	1	0	0
0.65	0	0	0	0	0	0	1	0	0	1	0	0
0.66	0	0	0	0	0	0	3	0	0	3	0	0
0.67	0	0	0	0	0	0	1	0	0	1	0	0
0.68	0	0	0	0	0	0	1	0	0	1	0	0
0.69	0	0	0	0	0	0	0	0	0	0	0	0
0.70	0	0	0	0	0	0	0	0	0	0	0	0
0.71	0	0	0	0	0	0	0	0	0	0	0	0
0.72	0	0	0	0	0	0	3	0	0	4	0	0
0.73	0	0	0	0	0	0	0	0	0	0	0	0
0.74	0	0	0	0	0	0	0	0	0	0	0	0
0.75	0	0	0	0	0	0	0	0	0	0	0	0
0.76	0	0	0	0	0	0	0	0	0	0	0	0
0.77	0	0	0	0	0	0	0	0	0	0	0	0
0.78	0	0	0	0	0	0	0	0	0	0	0	0
0.79	0	0	0	0	0	0	0	0	0	0	0	0
0.80	0	0	0	0	0	0	0	0	0	0	0	0
0.81	0	0	0	0	0	0	0	0	0	0	0	0
0.82	0	0	0	0	0	0	0	0	0	0	0	0
0.83	0	0	0	0	0	0	0	0	0	0	0	0
0.84	0	0	0	0	0	0	0	0	0	0	0	0
0.85	0	0	0	0	0	0	0	0	0	0	0	0
0.86	0	0	0	0	0	0	0	0	0	0	0	0
0.87	0	0	0	0	0	0	0	0	0	0	0	0
0.88	0	0	0	0	0	0	0	0	0	0	0	0
0.89	0	0	0	0	0	0	0	0	0	0	0	0
0.90	0	0	0	0	0	0	0	0	0	0	0	0
0.91	0	0	0	0	0	0	0	0	0	0	0	0
0.92	0	0	0	0	0	0	0	0	0	0	0	0
0.93	0	0	0	0	0	0	0	0	0	0	0	0
0.94	0	0	0	0	0	0	0	0	0	0	0	0
0.95	0	0	0	0	0	0	0	0	0	0	0	0
0.96	0	0	0	0	0	0	0	0	0	0	0	0
0.97	0	0	0	0	0	0	0	0	0	0	0	0
0.98	0	0	0	0	0	0	0	0	0	0	0	0
0.99	0	0	0	0	0	0	0	0	0	0	0	0
1.00	0	0	0	0	0	0	0	0	0	0	0	0
SUBTOTAL	0	0	0	25	11	0	77	64	0	102	75	0

~~TOP SECRET~~

TABLE 9-4

DENSITY VALUE	PRIMARY			INTERMEDIATE			FULL			ALL LEVELS		
	MIN	MAX	LIM	MIN	MAX	LIM	MIN	MAX	LIM	MIN	MAX	LIM
1.01	0	0	0	0	1	0	0	3	0	0	4	0
1.02	0	0	0	0	1	0	0	0	0	0	0	0
1.03	0	0	0	0	0	0	0	0	0	0	0	0
1.04	0	0	0	0	0	0	0	0	0	0	0	0
1.05	0	0	0	0	0	0	0	0	0	0	0	0
1.06	0	0	0	0	0	0	0	0	0	0	0	0
1.07	0	0	0	0	0	0	0	0	0	0	0	0
1.08	0	0	0	0	0	0	0	0	0	0	0	0
1.09	0	0	0	0	0	0	0	0	0	0	0	0
1.10	0	0	0	0	0	0	0	0	0	0	0	0
1.11	0	0	0	0	0	0	0	0	0	0	0	0
1.12	0	0	0	0	0	0	0	0	0	0	0	0
1.13	0	0	0	0	0	0	0	0	0	0	0	0
1.14	0	0	0	0	0	0	0	0	0	0	0	0
1.15	0	0	0	0	0	0	0	0	0	0	0	0
1.16	0	0	0	0	0	0	0	0	0	0	0	0
1.17	0	0	0	0	0	0	0	0	0	0	0	0
1.18	0	0	0	0	0	0	0	0	0	0	0	0
1.19	0	0	0	0	0	0	0	0	0	0	0	0
1.20	0	0	0	0	0	0	0	0	0	0	0	0
1.21	0	0	0	0	0	0	0	0	0	0	0	0
1.22	0	0	0	0	0	0	0	0	0	0	0	0
1.23	0	0	0	0	0	0	0	0	0	0	0	0
1.24	0	0	0	0	0	0	0	0	0	0	0	0
1.25	0	0	0	0	0	0	0	0	0	0	0	0
1.26	0	0	0	0	0	0	0	0	0	0	0	0
1.27	0	0	0	0	0	0	0	0	0	0	0	0
1.28	0	0	0	0	0	0	0	0	0	0	0	0
1.29	0	0	0	0	0	0	0	0	0	0	0	0
1.30	0	0	0	0	0	0	0	0	0	0	0	0
1.31	0	0	0	0	0	0	0	0	0	0	0	0
1.32	0	0	0	0	0	0	0	0	0	0	0	0
1.33	0	0	0	0	0	0	0	0	0	0	0	0
1.34	0	0	0	0	0	0	0	0	0	0	0	0
1.35	0	0	0	0	0	0	0	0	0	0	0	0
1.36	0	0	0	0	0	0	0	0	0	0	0	0
1.37	0	0	0	0	0	0	0	0	0	0	0	0
1.38	0	0	0	0	0	0	0	0	0	0	0	0
1.39	0	0	0	0	0	0	0	0	0	0	0	0
1.40	0	0	0	0	0	0	0	0	0	0	0	0
1.41	0	0	0	0	0	0	0	0	0	0	0	0
1.42	0	0	0	0	0	0	0	0	0	0	0	0
1.43	0	0	0	0	0	0	0	0	0	0	0	0
1.44	0	0	0	0	0	0	0	0	0	0	0	0
1.45	0	0	0	0	0	0	0	0	0	0	0	0
1.46	0	0	0	0	0	0	0	0	0	0	0	0
1.47	0	0	0	0	0	0	0	0	0	0	0	0
1.48	0	0	0	0	0	0	0	0	0	0	0	0
1.49	0	0	0	0	0	0	0	0	0	0	0	0
1.50	0	0	0	0	0	0	0	0	0	0	0	0
SUBTOTAL	0	0	0	3	37	3	2	82	7	5	119	10

TABLE 9-4

DENSITY VALUE	PRIMARY			INTERMEDIATE			FULL			ALL LEVELS		
	MIN	MAX	LIM	MIN	MAX	LIM	MIN	MAX	LIM	MIN	MAX	LIM
1.51	0	0	0	0	0	0	0	2	0	0	2	0
1.52	0	0	0	0	0	0	0	1	0	0	1	0
1.53	0	0	0	0	0	0	0	1	0	0	1	0
1.54	0	0	0	0	0	0	0	1	0	0	1	0
1.55	0	0	0	0	0	0	0	1	0	0	1	0
1.56	0	0	0	0	0	0	0	1	0	0	1	0
1.57	0	0	0	0	0	0	0	1	0	0	1	0
1.58	0	0	0	0	0	0	0	1	0	0	1	0
1.59	0	0	0	0	0	0	0	1	0	0	1	0
1.60	0	0	0	0	0	0	0	1	0	0	1	0
1.61	0	0	0	0	0	0	0	1	0	0	1	0
1.62	0	0	0	0	0	0	0	1	0	0	1	0
1.63	0	0	0	0	0	0	0	1	0	0	1	0
1.64	0	0	0	0	0	0	0	1	0	0	1	0
1.65	0	0	0	0	0	0	0	1	0	0	1	0
1.66	0	0	0	0	0	0	0	1	0	0	1	0
1.67	0	0	0	0	0	0	0	1	0	0	1	0
1.68	0	0	0	0	0	0	0	1	0	0	1	0
1.69	0	0	0	0	0	0	0	1	0	0	1	0
1.70	0	0	0	0	0	0	0	1	0	0	1	0
1.71	0	0	0	0	0	0	0	1	0	0	1	0
1.72	0	0	0	0	0	0	0	1	0	0	1	0
1.73	0	0	0	0	0	0	0	1	0	0	1	0
1.74	0	0	0	0	0	0	0	1	0	0	1	0
1.75	0	0	0	0	0	0	0	1	0	0	1	0
1.76	0	0	0	0	0	0	0	1	0	0	1	0
1.77	0	0	0	0	0	0	0	1	0	0	1	0
1.78	0	0	0	0	0	0	0	1	0	0	1	0
1.79	0	0	0	0	0	0	0	1	0	0	1	0
1.80	0	0	0	0	0	0	0	1	0	0	1	0
1.81	0	0	0	0	0	0	0	1	0	0	1	0
1.82	0	0	0	0	0	0	0	1	0	0	1	0
1.83	0	0	0	0	0	0	0	1	0	0	1	0
1.84	0	0	0	0	0	0	0	1	0	0	1	0
1.85	0	0	0	0	0	0	0	1	0	0	1	0
1.86	0	0	0	0	0	0	0	1	0	0	1	0
1.87	0	0	0	0	0	0	0	1	0	0	1	0
1.88	0	0	0	0	0	0	0	1	0	0	1	0
1.89	0	0	0	0	0	0	0	1	0	0	1	0
1.90	0	0	0	0	0	0	0	1	0	0	1	0
1.91	0	0	0	0	0	0	0	1	0	0	1	0
1.92	0	0	0	0	0	0	0	1	0	0	1	0
1.93	0	0	0	0	0	0	0	1	0	0	1	0
1.94	0	0	0	0	0	0	0	1	0	0	1	0
1.95	0	0	0	0	0	0	0	1	0	0	1	0
1.96	0	0	0	0	0	0	0	1	0	0	1	0
1.97	0	0	0	0	0	0	0	1	0	0	1	0
1.98	0	0	0	0	0	0	0	1	0	0	1	0
1.99	0	0	0	0	0	0	0	1	0	0	1	0
2.00	0	0	0	0	0	0	0	1	0	0	1	0
SUBTOTAL	0	0	0	1	22	14	1	38	23	2	60	42

TABLE 9-4

DENSITY VALUE	PRIMARY			INTERMEDIATE			FULL			ALL LEVELS		
	MIN	MAX	LIM	MIN	MAX	LIM	MIN	MAX	LIM	MIN	MAX	LIM
2.01	0	0	0	0	0	0	0	0	0	0	0	0
2.02	0	0	0	0	0	0	0	0	0	0	0	0
2.03	0	0	0	0	0	0	0	0	0	0	0	0
2.04	0	0	0	0	0	0	0	0	0	0	0	0
2.05	0	0	0	0	0	0	0	0	0	0	0	0
2.06	0	0	0	0	0	0	0	0	0	0	0	0
2.07	0	0	0	0	0	0	0	0	0	0	0	0
2.08	0	0	0	0	0	0	0	0	0	0	0	0
2.09	0	0	0	0	0	0	0	0	0	0	0	0
2.10	0	0	0	0	0	0	0	0	0	0	0	0
2.11	0	0	0	0	0	0	0	0	0	0	0	0
2.12	0	0	0	0	0	0	0	0	0	0	0	0
2.13	0	0	0	0	0	0	0	0	0	0	0	0
2.14	0	0	0	0	0	0	0	0	0	0	0	0
2.15	0	0	0	0	0	0	0	0	0	0	0	0
2.16	0	0	0	0	0	0	0	0	0	0	0	0
2.17	0	0	0	0	0	0	0	0	0	0	0	0
2.18	0	0	0	0	0	0	0	0	0	0	0	0
2.19	0	0	0	0	0	0	0	0	0	0	0	0
2.20	0	0	0	0	0	0	0	0	0	0	0	0
2.21	0	0	0	0	0	0	0	0	0	0	0	0
2.22	0	0	0	0	0	0	0	0	0	0	0	0
2.23	0	0	0	0	0	0	0	0	0	0	0	0
2.24	0	0	0	0	0	0	0	0	0	0	0	0
2.25	0	0	0	0	0	0	0	0	0	0	0	0
2.26	0	0	0	0	0	0	0	0	0	0	0	0
2.27	0	0	0	0	0	0	0	0	0	0	0	0
2.28	0	0	0	0	0	0	0	0	0	0	0	0
2.29	0	0	0	0	0	0	0	0	0	0	0	0
2.30	0	0	0	0	0	0	0	0	0	0	0	0
2.31	0	0	0	0	0	0	0	0	0	0	0	0
2.32	0	0	0	0	0	0	0	0	0	0	0	0
2.33	0	0	0	0	0	0	0	0	0	0	0	0
2.34	0	0	0	0	0	0	0	0	0	0	0	0
2.35	0	0	0	0	0	0	0	0	0	0	0	0
2.36	0	0	0	0	0	0	0	0	0	0	0	0
2.37	0	0	0	0	0	0	0	0	0	0	0	0
2.38	0	0	0	0	0	0	0	0	0	0	0	0
2.39	0	0	0	0	0	0	0	0	0	0	0	0
2.40	0	0	0	0	0	0	0	0	0	0	0	0
2.41	0	0	0	0	0	0	0	0	0	0	0	0
2.42	0	0	0	0	0	0	0	0	0	0	0	0
2.43	0	0	0	0	0	0	0	0	0	0	0	0
2.44	0	0	0	0	0	0	0	0	0	0	0	0
2.45	0	0	0	0	0	0	0	0	0	0	0	0
2.46	0	0	0	0	0	0	0	0	0	0	0	0
2.47	0	0	0	0	0	0	0	0	0	0	0	0
2.48	0	0	0	0	0	0	0	0	0	0	0	0
2.49	0	0	0	0	0	0	0	0	0	0	0	0
2.50	0	0	0	0	0	0	0	0	0	0	0	0
SUBTOTAL	0	0	0	0	0	0	0	0	0	0	0	0

TABLE 9-4

MISSION • 1023-2 • INSTRUMENT • AFT • 12-06-65 • DENSITY FREQ DISTR

DENSITY VALUE	PRIMARY			INTERMEDIATE			FULL			ALL LEVELS		
	MIN	MAX	LIM	MIN	MAX	LIM	MIN	MAX	LIM	MIN	MAX	LIM
2.51	0	0	0	0	0	0	0	0	0	0	0	0
2.52	0	0	0	0	0	0	0	0	0	0	0	0
2.53	0	0	0	0	0	0	0	0	0	0	0	0
2.54	0	0	0	0	0	0	0	0	0	0	0	0
2.55	0	0	0	0	0	0	0	0	0	0	0	0
2.56	0	0	0	0	0	0	0	0	0	0	0	0
2.57	0	0	0	0	0	0	0	0	0	0	0	0
2.58	0	0	0	0	0	0	0	0	0	0	0	0
2.59	0	0	0	0	0	0	0	0	0	0	0	0
2.60	0	0	0	0	0	0	0	0	0	0	0	0
2.61	0	0	0	0	0	0	0	0	0	0	0	0
2.62	0	0	0	0	0	0	0	0	0	0	0	0
2.63	0	0	0	0	0	0	0	0	0	0	0	0
2.64	0	0	0	0	0	0	0	0	0	0	0	0
2.65	0	0	0	0	0	0	0	0	0	0	0	0
2.66	0	0	0	0	0	0	0	0	0	0	0	0
2.67	0	0	0	0	0	0	0	0	0	0	0	0
2.68	0	0	0	0	0	0	0	0	0	0	0	0
2.69	0	0	0	0	0	0	0	0	0	0	0	0
2.70	0	0	0	0	0	0	0	0	0	0	0	0
SUBTOTAL	0	0	0	0	0	0	0	0	0	0	0	0
TOTAL	0	0	0	74	74	70	190	190	155	264	264	225

MISSION 1023-2 INSTR - AFT 12-06-65 PROCESSING AND EXPOSURE ANALYSIS

PROCESS LEVEL	SAMPLE SIZE	UNDER EXPOSED	UNDER PROCESSED	CORRECT EXP+PROC	OVER PROCESSED	OVER EXPOSED
PRIMARY	0	0 PC	0 PC	0 PC	0 PC	0 PC
INTERMEDIATE	74	0 PC	35 PC	57 PC	7 PC	1 PC
FULL	190	18 PC	0 PC	79 PC	3 PC	0 PC
ALL LEVELS	264	13 PC	10 PC	73 PC	4 PC	0 PC

PROCESS LEVEL	BASE + FUG	UNDER EXPOSED	UNDER PROCESSED	CORRECT EXP+PROC	OVER PROCESSED	OVER EXPOSED
PRIMARY	0.01-0.09	0.01-0.13	0.14-0.39	0.40-0.90	-----	0.91 AND L
INTERMED	0.10-0.17	0.01-0.20	0.21-0.39	0.40-0.90	0.91-1.34	1.35 AND L
FULL	0.18 AND UP	0.01-0.39	-----	0.40-0.90	0.91-1.69	1.70 AND L

TABLE 9-4

MISSION • 1023-2 • INSTR • AFI • 12-06-65 PLOT OF D MIN • TERRAIN • PROCESSING • INTERMEDIATE  
 ARITH MEAN • 0.54 • MEDIAN • 0.47 • STD DEV • 0.26 • RANGE • 0.22 TO 1.56 WITH 74 SAMPLES

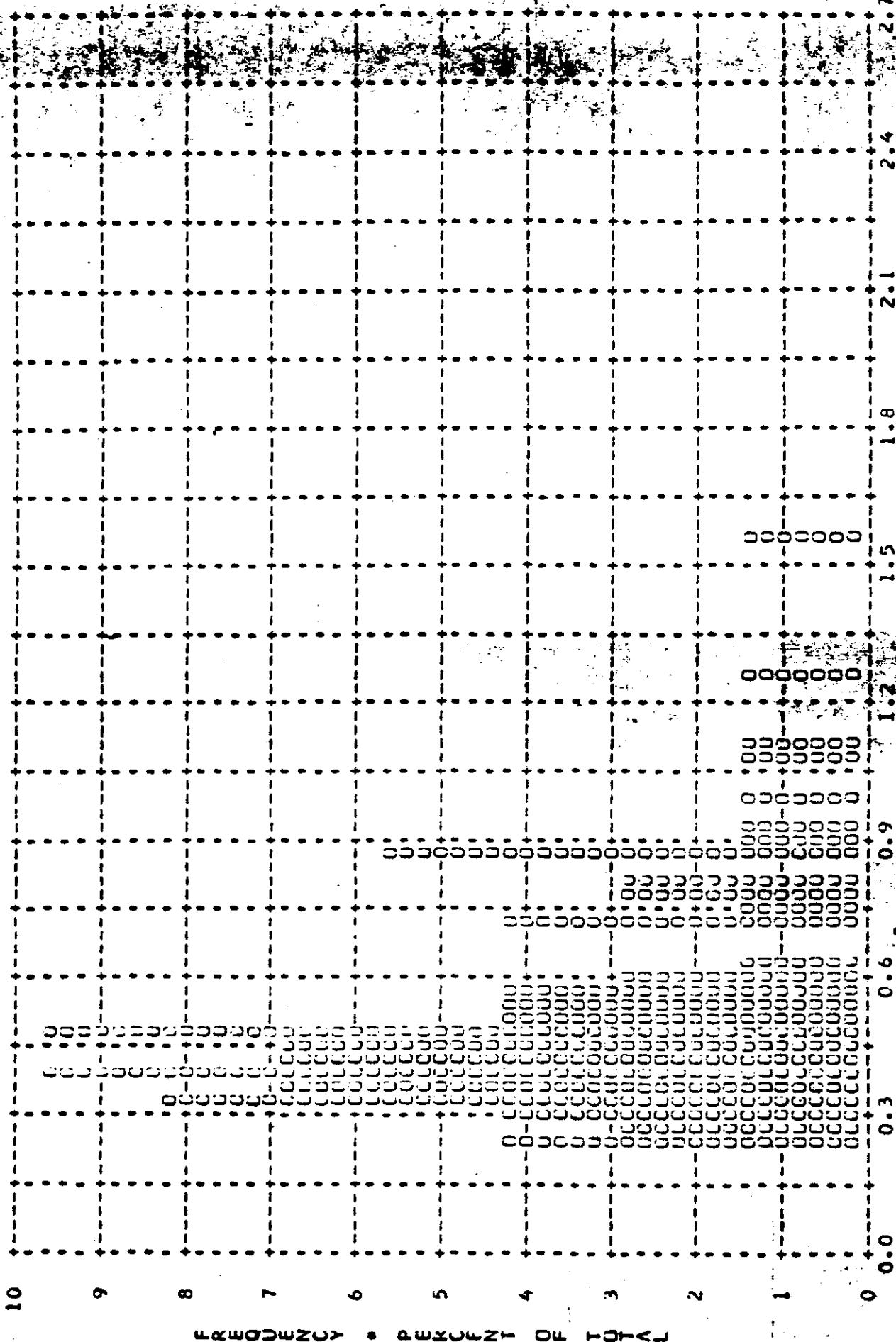

FIGURE 9-28 • DENSITY



~~TOP SECRET~~

MISSION \* 1023-2 \* INSTR \* AFI \* 12-06-65 PLOT OF U MAX \* TERKAIN \* PROCESSING \* INTERMEDIATE  
ARITH MEAN \* 1.35 \* MEDIAN \* 1.36 \* STD DEV \* 0.37 \* RANGE \* 0.44 TU 2.20 WITH 74 SAMPLES

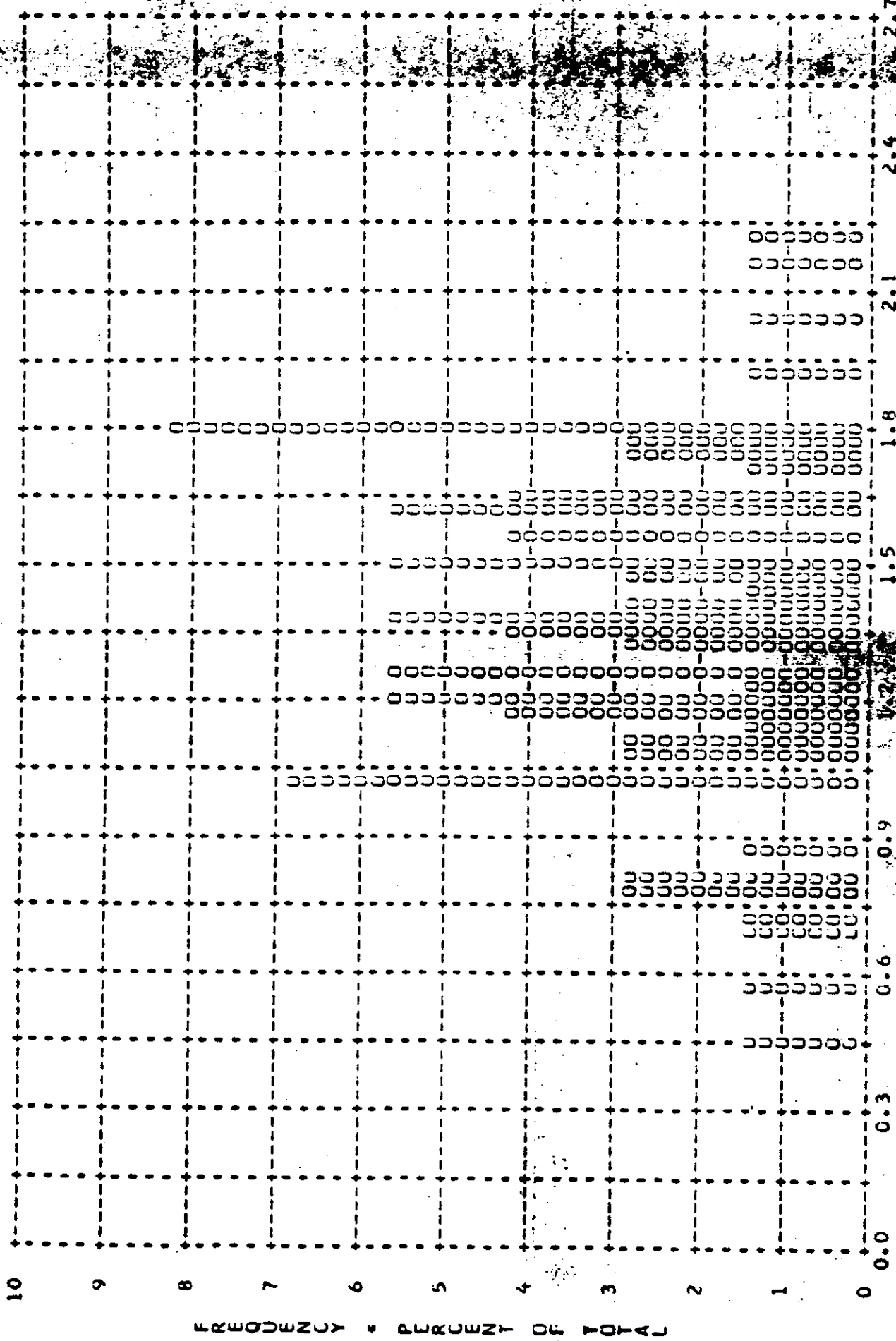

FIGURE 9-29

~~TOP SECRET~~

MISSION • 1023-2 • INSTR • AFI • 12-06-65 PLOT OF D MAX • CLOUD • PROCESSING • INTERMEDIATE  
ARITH MEAN • 2.05 • MEDIAN • 2.14 • STD DEV • 0.24 • RANGE • 1.26 TO 2.39 WITH 70 SAMPLES

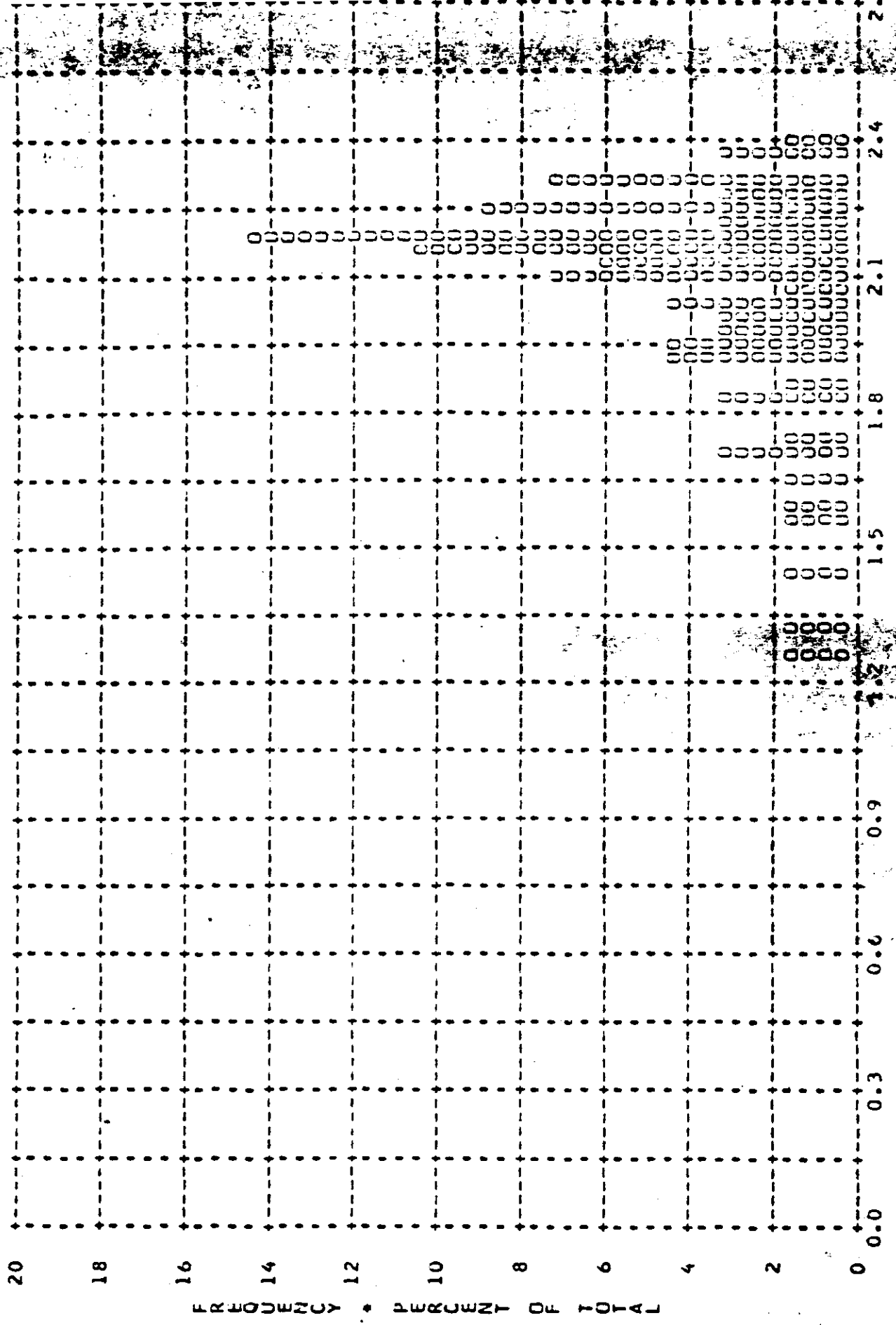

FIGURE 9-30 • DENSITY •

~~TOP SECRET~~

MISSION • 1023-2 • INSTR • AFT • 12-06-65 PLOT OF U MIN • TERRAIN • PROCESSING • FULL  
ARITH MEAN • 0.52 • MEDIAN • 0.48 • SID DLV • 0.16 • RANGE • 0.30 TO 1.60 WITH 190 SAMPLES

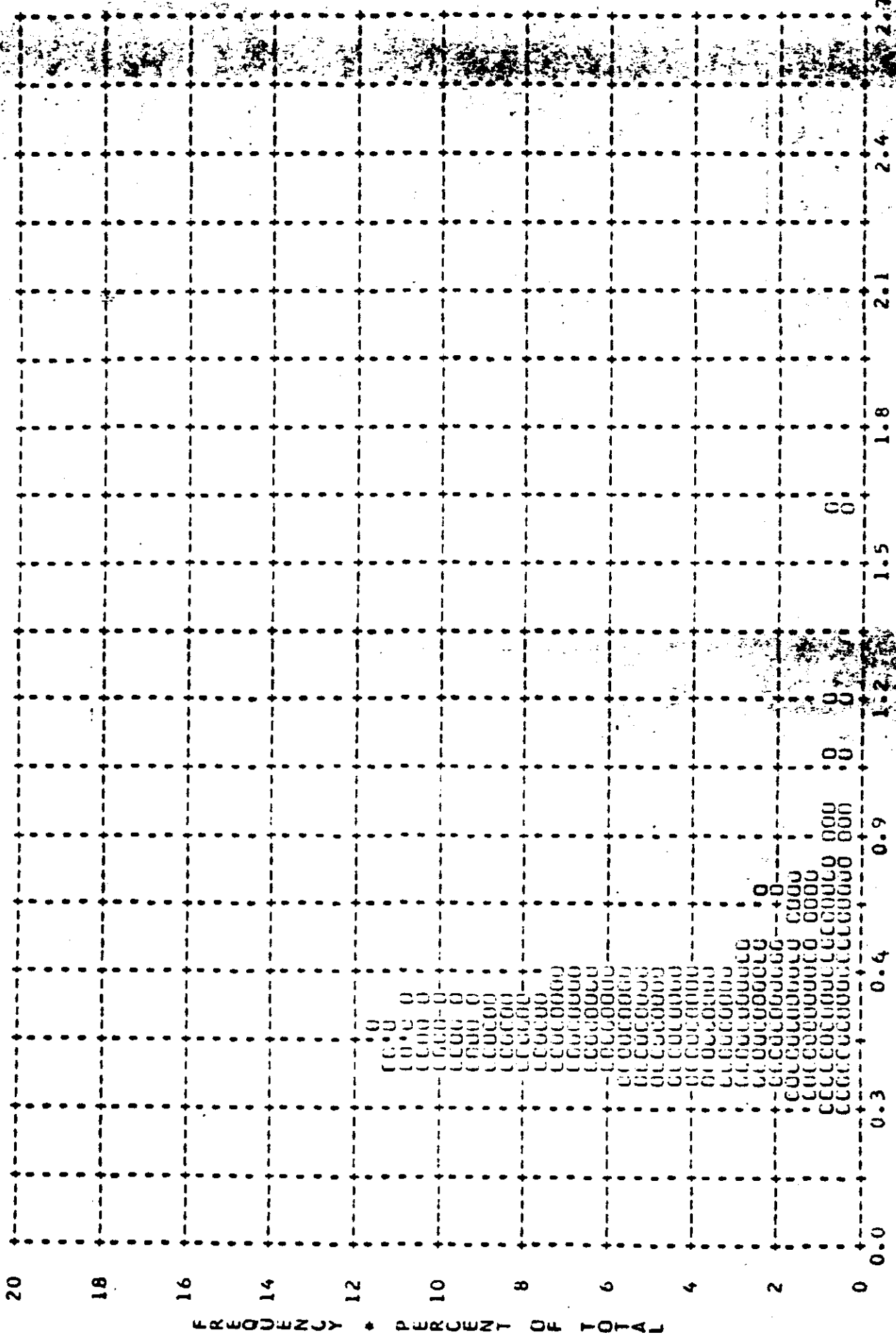

FIGURE 9-31

FORM 55-C-111

MISSION • 1023-2 • INSTR • AFI • 12-06-65 PLOT OF D MAX • TERRAIN • PROCESSING • FULL  
ARITH MEAN • 1.20 • MEDIAN • 1.20 • STD DEV • 0.38 • RANGE • 0.47 TO 2.31 WITH 190 SAMPLES

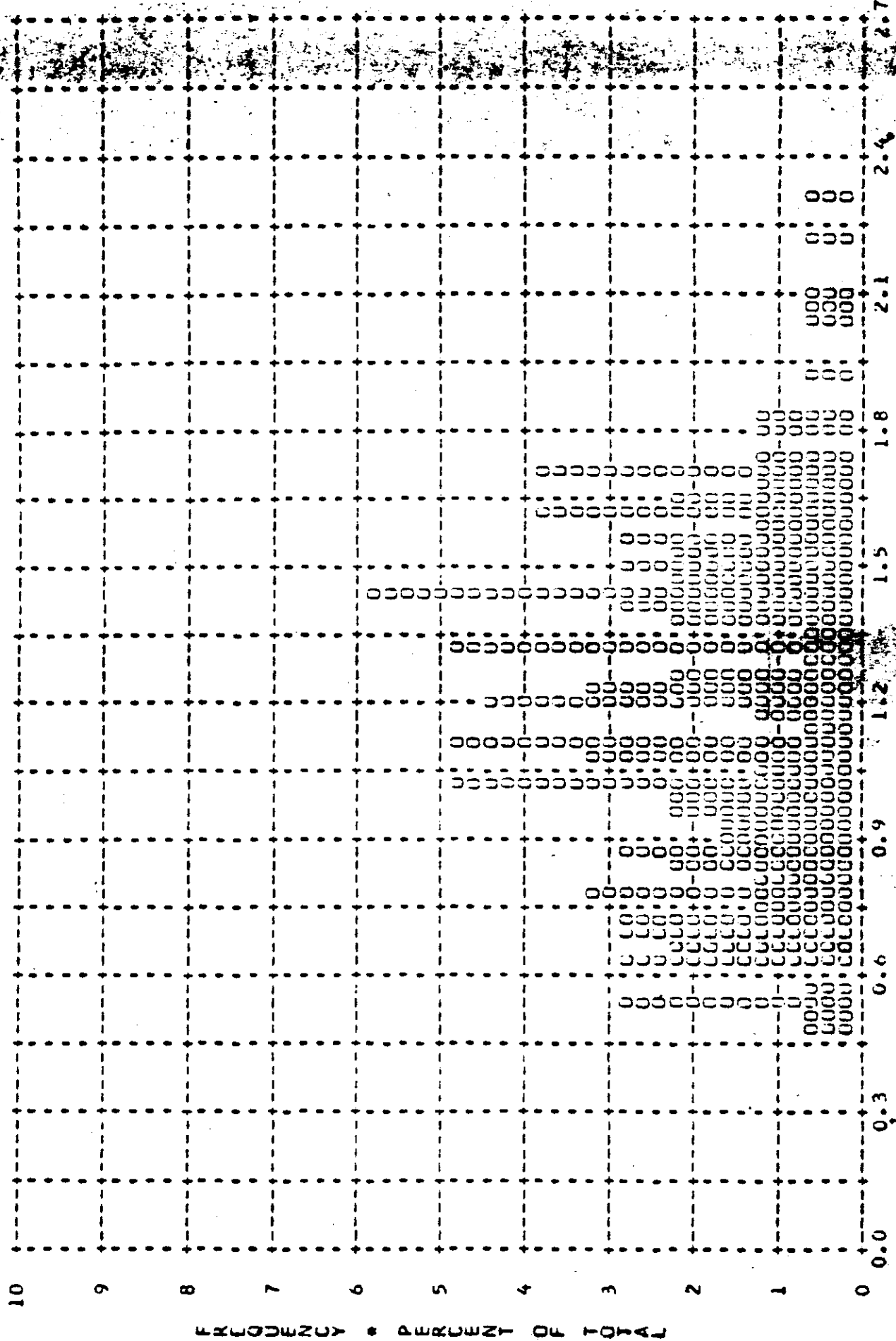

FIGURE 9-32 • DENSITY •

~~TOP SECRET~~

MISSION • 1023-2 • INSIK • AFT • 12-06-65 PLOT OF D MAX • CLOUD • PROCESSING • FULL  
ARITH MEAN • 2.12 • MEDIAN • 2.20 • STD DEV • 0.25 • RANGE • 1.08 TO 2.46 WITH 155 SAMPLES

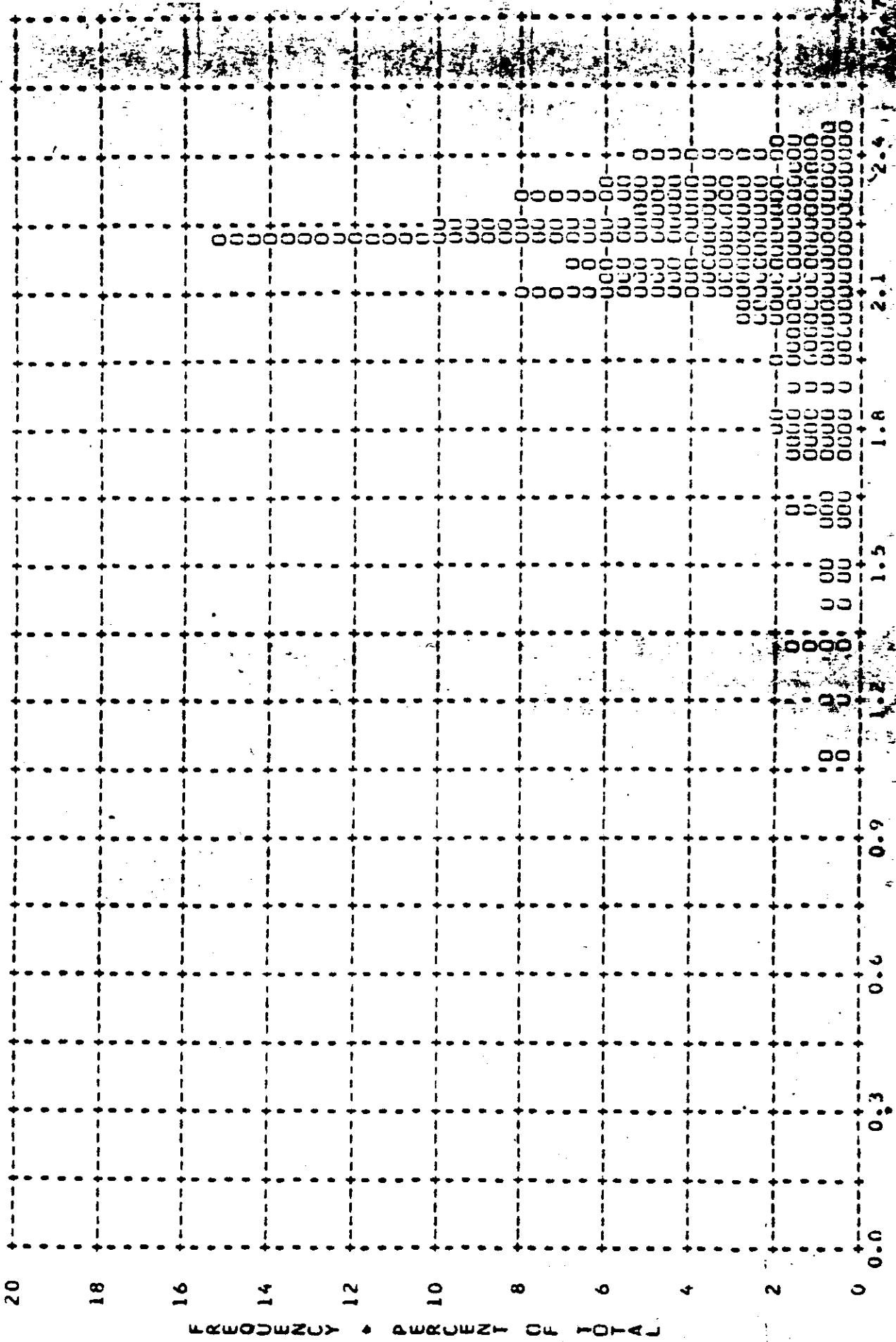

FIGURE 9-33

~~TOP SECRET~~

MISSION • 1023-2 • INSTR • AFT • 12-06-65 PLOT OF 0 MIN • TERRAIN • PROCESSING • ALL LEVELS  
ARITH MEAN • 0.52 • MEDIA • 0.48 • STD DEV • 0.19 • RANGE • 0.22 TO 1.60 WITH 264 SAMPLES

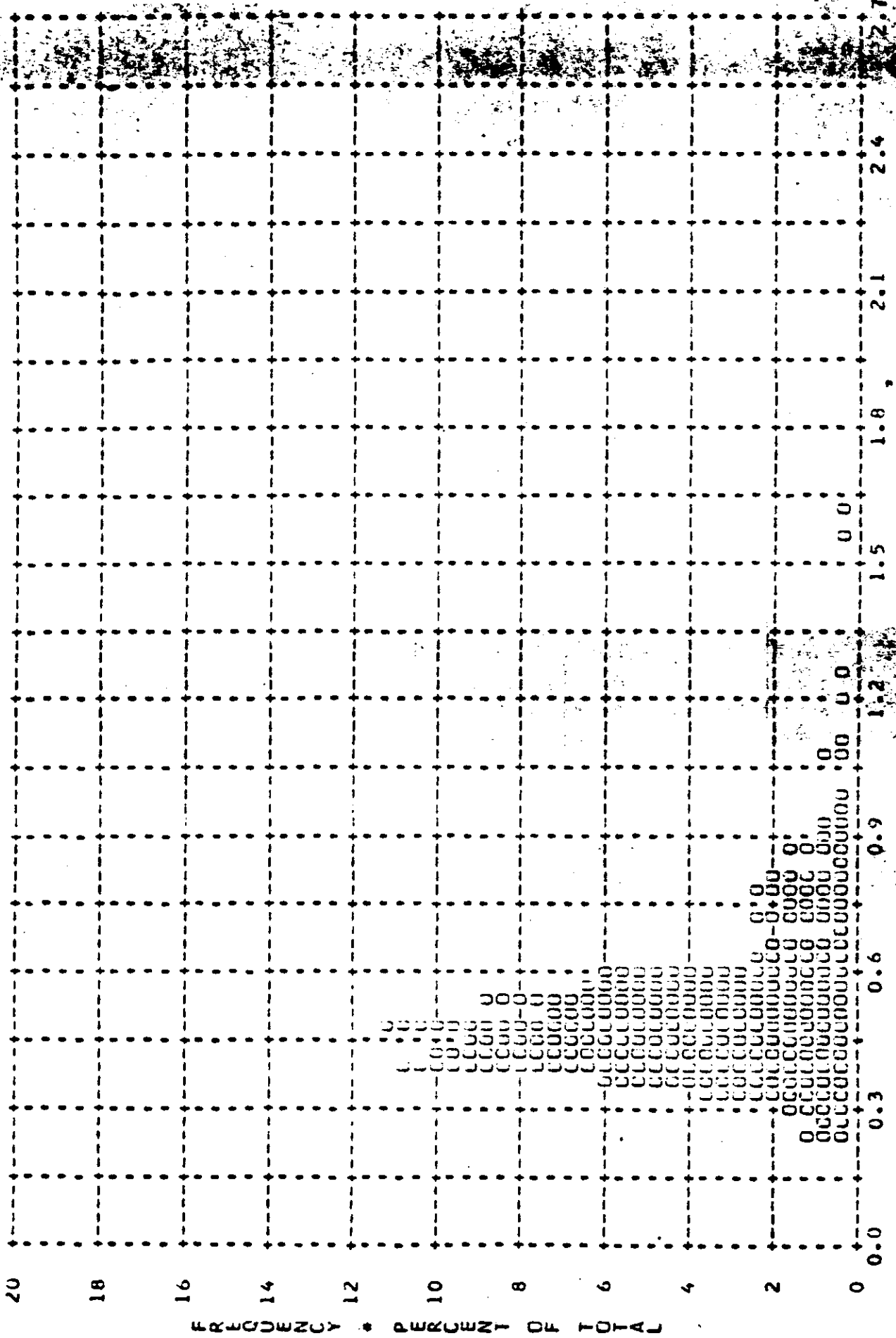

FIGURE 9-34

~~TOP SECRET~~

MISSION • 1023-2 • INSIR • AFT • 12-06-65 PLOT OF D MAX • TERRAIN • PROCESSING • ALL LEVELS  
ARITH MEAN • 1.24 • MEDIAN • 1.24 • STD DEV • 0.39 • RANGE • 0.44 TO 2.31 WITH 264 SAMPLES

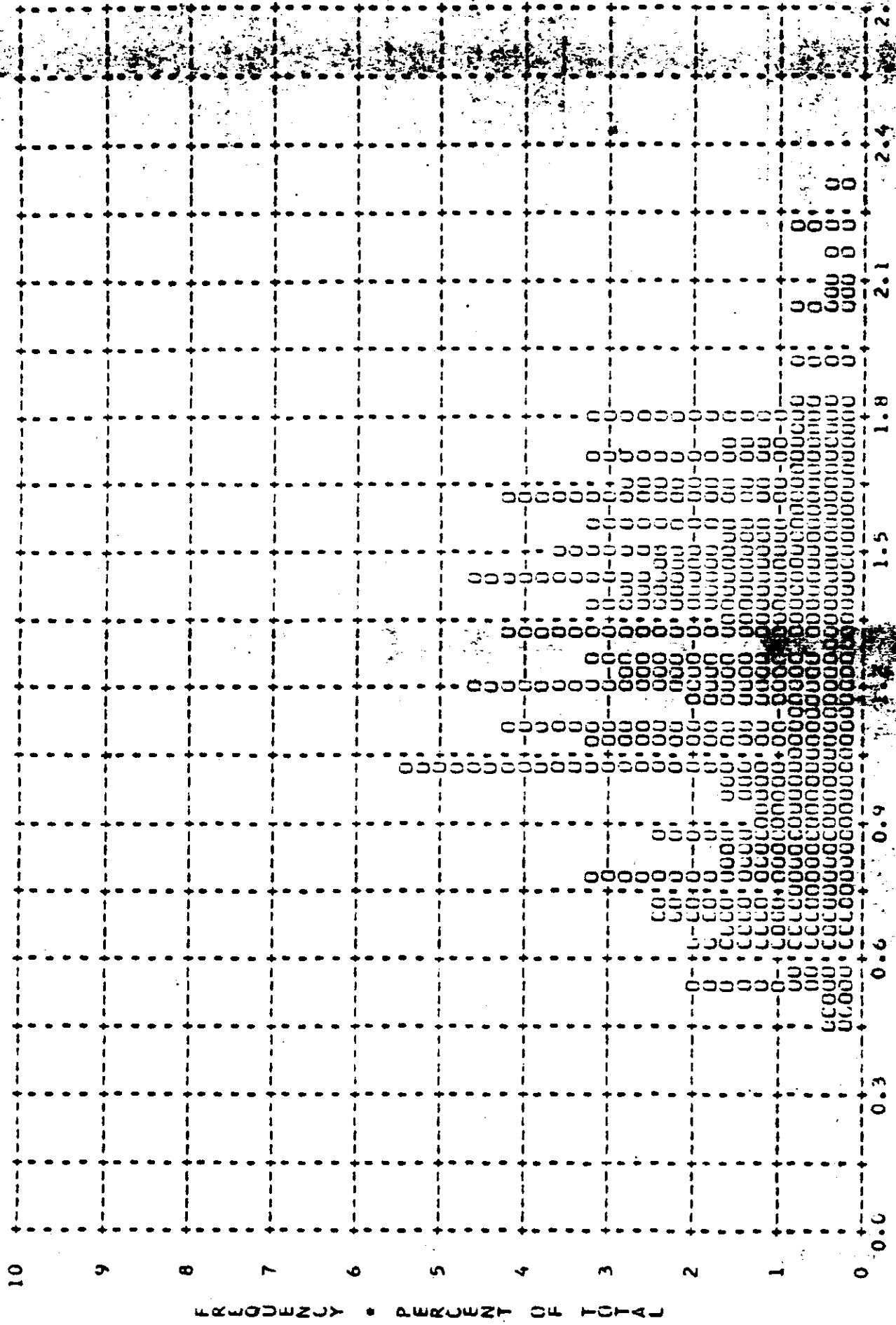

FIGURE 9-35 • DENSITY •

MISSION • 1023-2 • INSTR • AFT • 12-06-65 PLOT OF U MAX • CLOUD • PROCESSING • ALL LEVELS  
 ARITH MEAN • 2.10 • MEDIAN • 2.17 • STD DEV • 0.25 • RANGE • 1.08 TO 2.46 WITH 225 SAMPLES

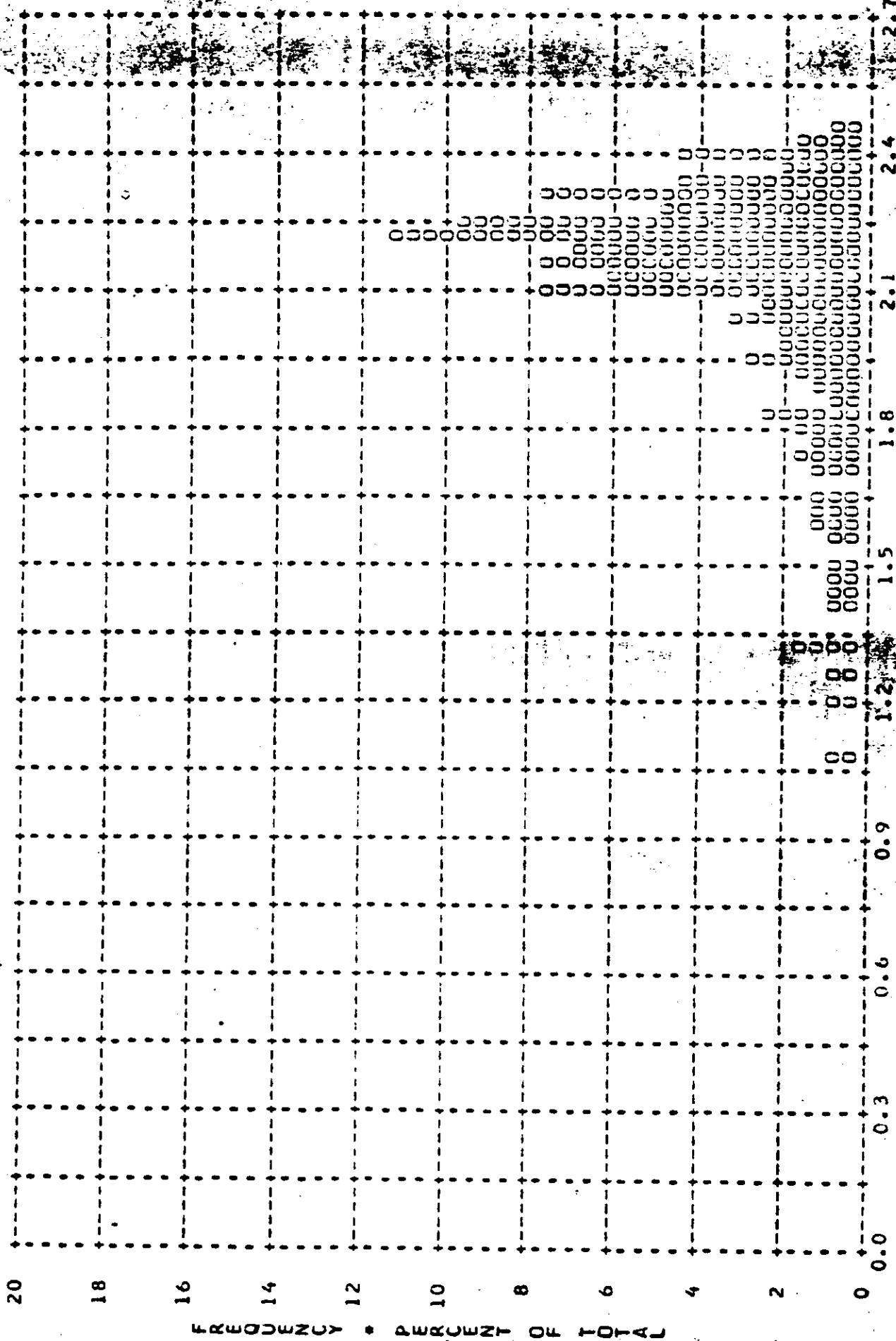

FIGURE 9-36



~~TOP SECRET~~

MISSION 1023-1		INSTR - FRWD	12-06-65	PROCESSING AND EXPOSURE ANALYSIS		
PROCESS LEVEL	SAMPLE SIZE	UNDER EXPOSED	UNDER PROCESSED	CORRECT EXP+PROC	OVER PROCESSED	OVER EXPOSED
PRIMARY	0	0 PC	0 PC	0 PC	0 PC	0 PC
INTERMEDIATE	200	4 PC	60 PC	32 PC	2 PC	0 PC
FULL	78	60 PC	0 PC	38 PC	1 PC	0 PC
ALL LEVELS	278	20 PC	44 PC	34 PC	2 PC	0 PC

MISSION 1023-1		INSTR - AFT	12-06-65	PROCESSING AND EXPOSURE ANALYSIS		
PROCESS LEVEL	SAMPLE SIZE	UNDER EXPOSED	UNDER PROCESSED	CORRECT EXP+PROC	OVER PROCESSED	OVER EXPOSED
PRIMARY	0	0 PC	0 PC	0 PC	0 PC	0 PC
INTERMEDIATE	113	1 PC	34 PC	54 PC	11 PC	1 PC
FULL	155	22 PC	0 PC	73 PC	3 PC	0 PC
ALL LEVELS	268	13 PC	14 PC	65 PC	7 PC	0 PC

MISSION 1023-2		INSTR - FRWD	12-06-65	PROCESSING AND EXPOSURE ANALYSIS		
PROCESS LEVEL	SAMPLE SIZE	UNDER EXPOSED	UNDER PROCESSED	CORRECT EXP+PROC	OVER PROCESSED	OVER EXPOSED
PRIMARY	0	0 PC	0 PC	0 PC	0 PC	0 PC
INTERMEDIATE	24	0 PC	13 PC	75 PC	8 PC	4 PC
FULL	111	42 PC	0 PC	57 PC	1 PC	0 PC
ALL LEVELS	135	35 PC	2 PC	60 PC	2 PC	1 PC

MISSION 1023-2		INSTR - AFT	12-06-65	PROCESSING AND EXPOSURE ANALYSIS		
PROCESS LEVEL	SAMPLE SIZE	UNDER EXPOSED	UNDER PROCESSED	CORRECT EXP+PROC	OVER PROCESSED	OVER EXPOSED
PRIMARY	0	0 PC	0 PC	0 PC	0 PC	0 PC
INTERMEDIATE	74	0 PC	35 PC	57 PC	7 PC	1 PC
FULL	190	18 PC	0 PC	79 PC	3 PC	0 PC
ALL LEVELS	264	13 PC	10 PC	73 PC	4 PC	0 PC

PROCESS LEVEL	BASE + FOG	UNDER EXPOSED	UNDER PROCESSED	CORRECT EXP+PROC	OVER PROCESSED	OVER EXPOSED
PRIMARY	0.01-0.09	0.01-0.13	0.14-0.39	0.40-0.90	-----	0.91 AND UP
INTERMED	0.10-0.17	0.01-0.20	0.21-0.39	0.40-0.90	0.91-1.34	1.35 AND UP
FULL	0.18 AND UP	0.01-0.39	-----	0.40-0.90	0.91-1.69	1.70 AND UP

~~TOP SECRET~~

TABLE 9-5

SECTION 10

PERFORMANCE MEASUREMENTS

The photography acquired by both panoramic cameras during Missions 1023-1 and 1023-2 received a MIP rating of 85. A summary is tabulated below of the average visual RES values and MTF/AIM resolution values measured by AFSPPL and the MTF/AIM resolution values made by

The length of the microdensitometer slit used by AFSPPL and was 80 microns; both slits were one micron wide.

<u>Mission</u>	<u>Camera</u>	<u>AFSPPL</u>	<u>All</u>	<u>High</u>
1023-1	FWD	94	97.1	109.6
1023-1	AFT	87	82.6	101.0
1023-2	FWD	71	76.0	87.4
1023-2	AFT	89	68.1	76.4

The data normally contains at least three readings of the same edge the tabulation shows both the average of all the readings and the average of the highest readings of each edge. The value of the average of all readings is questionable as no valid reason can be ascertained for a measurement being greater than the resolution recorded however many factors can reduce the reading.

The details of the measurement and computing techniques, targets measured and target locations are fully reported in the evaluation report published by AFSPPL and are therefore not included in this report. AFSPPL is no longer recording the Visual RES data hence these values will no longer be recorded in this Section and on the summary sheets in Section 18.

~~TOP SECRET~~

## SECTION 11

### OBSERVED DATA

Photographs of CORN targets on Mission 1023 included fixed targets at Indian Springs and Pahrump on Pass D47. Mobile targets were photographed at Pahrump on D47 and Columbus, Ohio on D77. Operation also occurred at WPAFB and Independence, California but these targets were obscured by weather.

The fixed target at Pahrump exhibited the least atmospheric degradation. Both forward and aft cameras resolved 9-1/2 feet along track and 13-1/2 feet cross track. However, many objects smaller than this were examined and identified. Engine nacells on P-3A aircraft at Moffett, NAS, cars and trucks on roads and parking lots could be isolated. 36 inch suspension cables on Golden Gate and Bay bridges were easily seen with only 10X magnification. The fine, lacy detail of the Bay bridge cantilever span was clearly seen as was the 42" Hetch Hetchy aqueduct on the Nimitz Freeway overcrossing.

An interesting and unusual anomaly was found in Pass D63 forward. Autos on Highway 17, 5 miles north of Los Gatos exhibited nearly 50 feet of in-track smear. A careful examination revealed that the smear extended all the way across the minor axis of the format but in a band only about one inch wide. No other area of this particular frame, 14, was affected. The same area of the format of frame 13 was also smeared, no more could be found.

This smear corresponds to a large IMC error at a high rate. The magnitudes are such that the vehicle could not have been responsible. The only logical conclusion is that a small piece of foreign material got into the IMC cam and follower and was ground up or discharged after two cycles. No other frames could be found to be affected.

~~TOP SECRET~~

SECTION 12

MISSION 1023-1 STELLAR-INDEX CAMERA

A. COMPONENT ASSIGNMENT

<u>Component</u>	<u>Serial Number</u>
Camera	D 17
Index Reseau	19
Stellar Reseau	82

B. CAMERA DATA AND FLIGHT SETTINGS

Stellar Camera:

Lens	85 mm f/1.8
Exposure Time	2 seconds
Filter Type	None
Film Type	Eastman Type 4401

Index Camera:

Lens	38 mm f/4.5
Exposure Time	1/500 second
Filter Type	Wratten 21
Film Type	Eastman Type 4400

C. POST FLIGHT EVALUATION

The Stellar and Index cameras operated properly throughout the mission. The Stellar camera produced 419 frames while the Index camera produced 420 frames. This variation was caused by the premature depletion of the film supply in the Stellar camera.

The degree of flare, within the Stellar formats was greater than usual as approximately 60% of the format contained fog. A 0.44 inch diameter circle of heavy fog was located within the flared portion of the format. This circle is attributed to the imaging of the rear lens element on the film as the excessive flare light reflected from the film and illuminated the rear portion of the lens cell.

~~TOP SECRET~~

The stellar field was recorded as points rather than double or streaked images, indicating that the panoramic cameras were running in synchronism. Some edge static was present throughout the mission but did not extend into the format area.

The Index camera film also showed some edge fogging which may have been the result of static discharge or emulsion cracking. The general quality of the Index camera photography was considered lower than usual as at least 80% of all frames were noticeably degraded by atmospheric haze.

The evaluation team has concluded that the magnitude of atmospheric haze can be more readily ascertained from the Index camera photography rather than the panoramic camera photography. As a result the Index camera film is evaluated first in order to determine the potential degradation that may be expected in the panoramic film. Further, it is postulated that the processed Index camera film can provide a useful tool in determining the proper level of processing to be applied to the panoramic camera film.

~~TOP SECRET~~

~~TOP SECRET~~

SECTION 13

MISSION 1023-2 STELLAR-INDEX CAMERA

A. COMPONENT ASSIGNMENT

<u>Component</u>	<u>Serial Number</u>
Camera	D 66
Index Reseau	75
Stellar Reseau	72

B. CAMERA DATA AND FLIGHT SETTINGS

Stellar Camera:

Lens	85 mm f/1.8
Exposure Time	2 seconds
Filter Type	None
Film Type	Eastman Type 4401

Index Camera:

Lens	38 mm f/4.5
Exposure Time	1/500 second
Filter Type	Wratten 21
Film Type	Eastman Type 4400

C. POST FLIGHT EVALUATION

The Stellar and Index cameras operated properly during the mission when they received the step function commands from the programmer. These step functions are sequenced by the closure of the center-of-format switch in the Master camera hence the failure of this camera during this mission precluded any further Stellar-Index camera exposures. Both the Stellar and Index cameras produced 213 photographic frames.

~~TOP SECRET~~

~~TOP SECRET~~ [REDACTED]

The operation of the Stellar-Index camera from the Master camera only can result in the loss of data during monoscopic operation of the Slave camera, during Stereo suppress operation as well as the experienced failure mode. It is recommended that consideration be given to a back-up signal from the Slave camera to properly sequence the programmer.

The stellar imagery displayed some streaking similar to that observed during prior missions. This anomaly may have been the result of the monoscopic operation of the Slave camera and the greater degree of unbalance imparted to the system.

The flare in the stellar formats was greater in area as compared with Mission 1023-1 but significantly less in magnitude. It would be expected that the magnitude of the fogged area would be equal to or greater than the Mission 1023-1 results. This area is under study however this anomaly may be due to small variations in the camera exposure characteristics or extended baffle installation tolerances.

The Index camera photography was degraded by emulsion scratches throughout the mission. It is extremely difficult to determine the source of this problem however additional caution is being exercised in the pre-flight cleanliness of the camera.

~~TOP SECRET~~ [REDACTED]

SECTION 14

VEHICLE ATTITUDE

The vehicle attitude errors for both Mission 1023-1 and 1023-2 were derived from the reduction of the Stellar camera photography. This attitude data is supplied to A/P by NPIC.

The attitude errors for each frame and the attitude control rates are calculated at the A/P computer facility. The computer also plots the frequency distribution of the rates and errors. Figures 14-1 through 14-6 show these distributions for Mission 1023-1 and Figures 14-7 through 14-14 for Mission 1023-2.

The summary table below lists the maximum attitude errors and rates that were experienced during 90% of the FWD camera photographic operations, excluding the first six frames of each operation, and the total range of the errors and rates.

<u>Value</u>	<u>Mission 1023-1</u>		<u>Mission 1023-2</u>	
	<u>90%</u>	<u>Range</u>	<u>90%</u>	<u>Range</u>
Pitch Error ( $^{\circ}$ )	0.49	-0.40 to +1.05	0.42	-0.42 to +0.68
Roll Error ( $^{\circ}$ )	0.33	-0.34 to +0.64	0.36	-0.52 to +0.40
Yaw Error ( $^{\circ}$ )	0.50	-0.95 to +1.05	0.53	-0.90 to +0.95
Pitch Rate ( $^{\circ}$ /hr)	33.0	-54 to +68	29.7	-60 to +90
Roll Rate ( $^{\circ}$ /hr)	28.7	-95 to +80	21.0	-60 to +70
Yaw Rate ( $^{\circ}$ /hr)	23.5	-54 to +50	28.6	-58 to +54

The performance of the attitude control system is comparable to the control systems used on recent missions. The panoramic photography was not degraded by the attitude control system.



PITCH ANGLE ERROR - DEGREES (X) VERSUS FREQUENCY - PERCENT (Y)

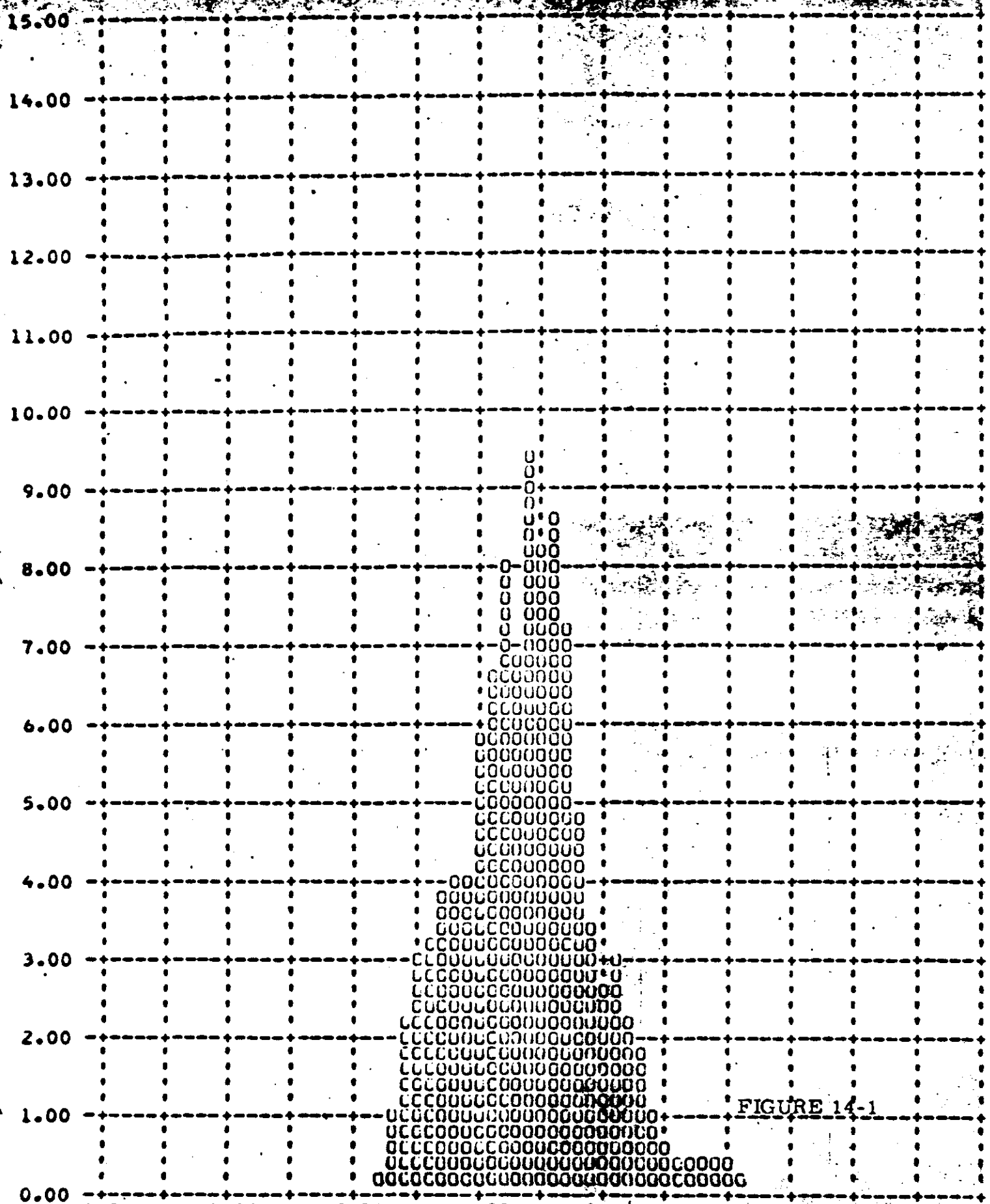

FIGURE 14-1

J-23 A BUCKET - FWD INSTR FRAMES 1-6 OF EACH OP OMITTED 90 PERCENT = 0.3

Y ROLL ANGLE ERROR - DEGREES (X) VERSUS EFFICIENCY - PERCENT (Y)

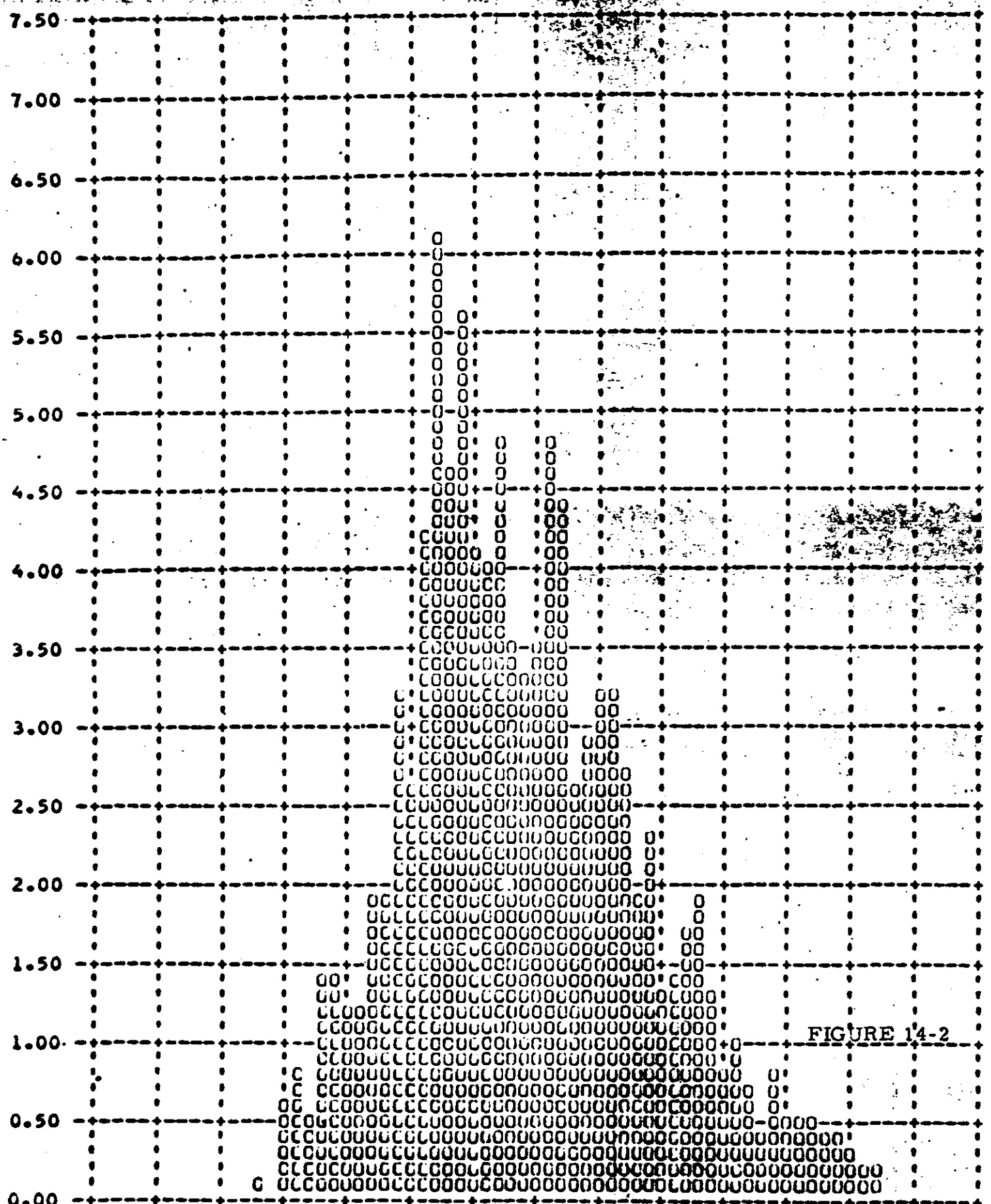

FIGURE 14-2

J-23 A BUCKET - FWD INSTR      FRAMES 1-6 OF EACH OP OMITTED      90 PERCENT      Q.5  
Y.      YAW ANGLE ERROR - DEGREES (X) VERSUS FREQUENCY - PERCENT (Y)

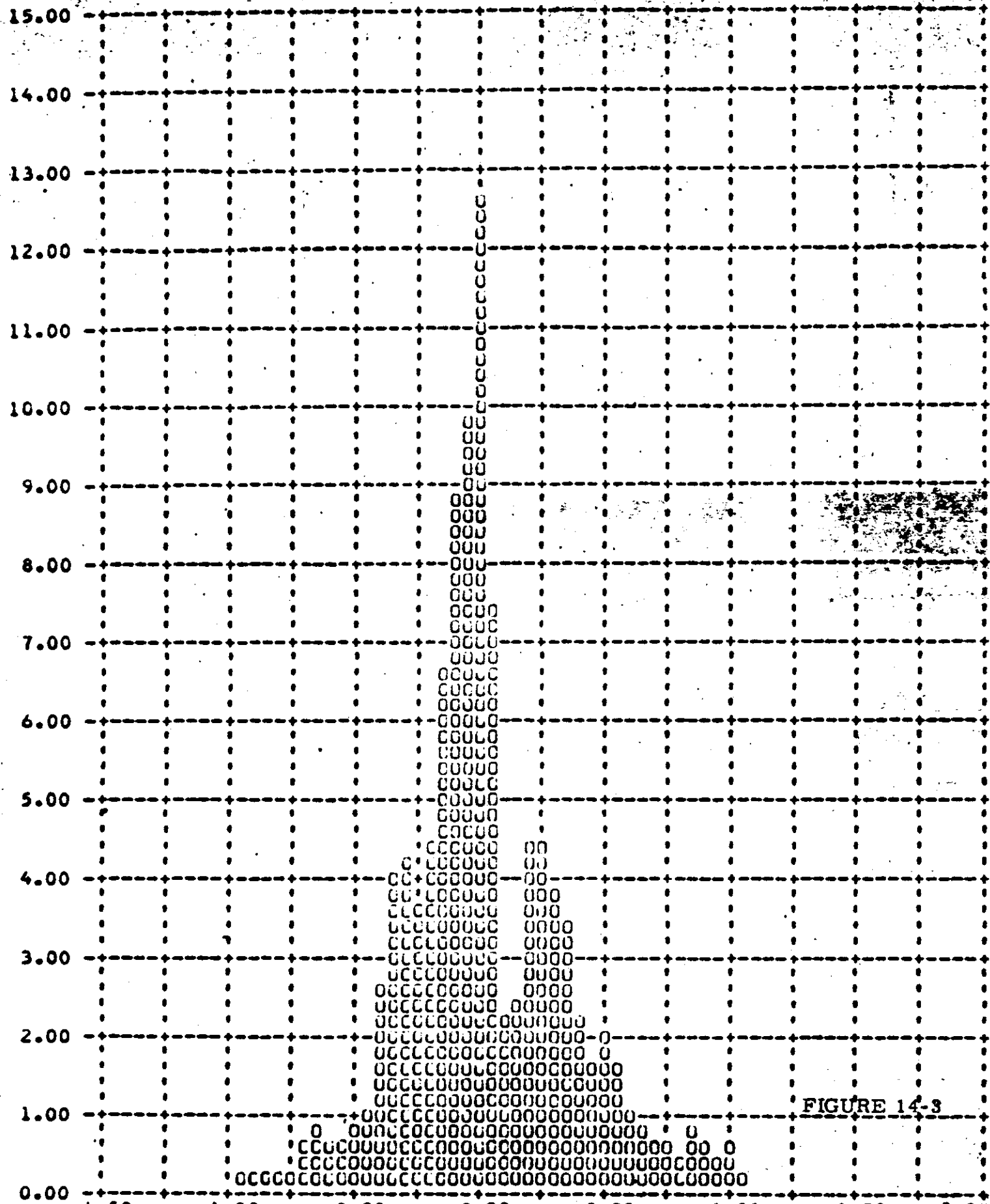

FIGURE 14-3

PITCH RATE ERROR - DEG/HOUR (X) VERSUS FREQUENCY - PERCENT (Y)

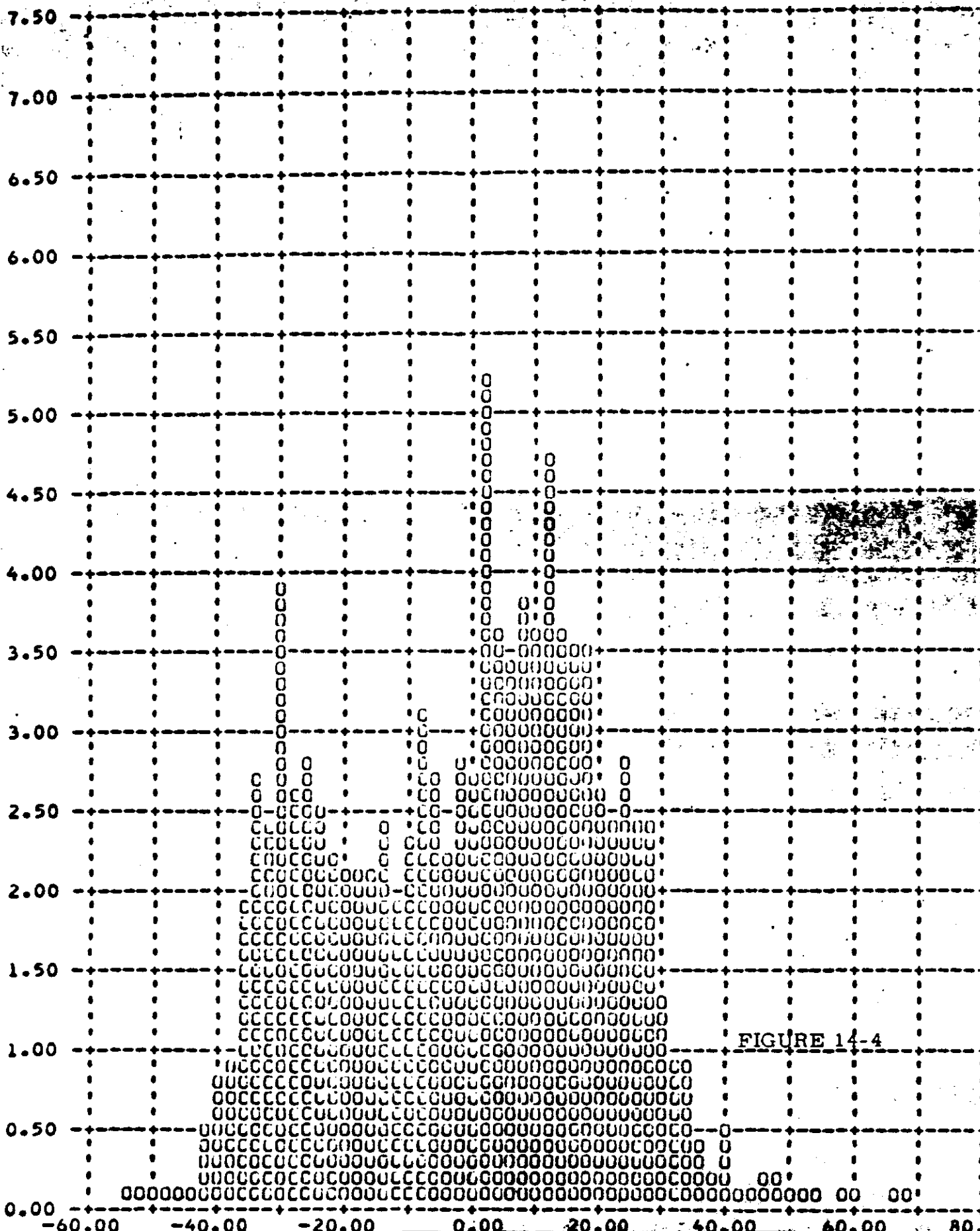

FIGURE 14-4

ROLL RATE ERROR - DEG/HOUR (X) VERSUS FREQUENCY - PERCENT (Y)

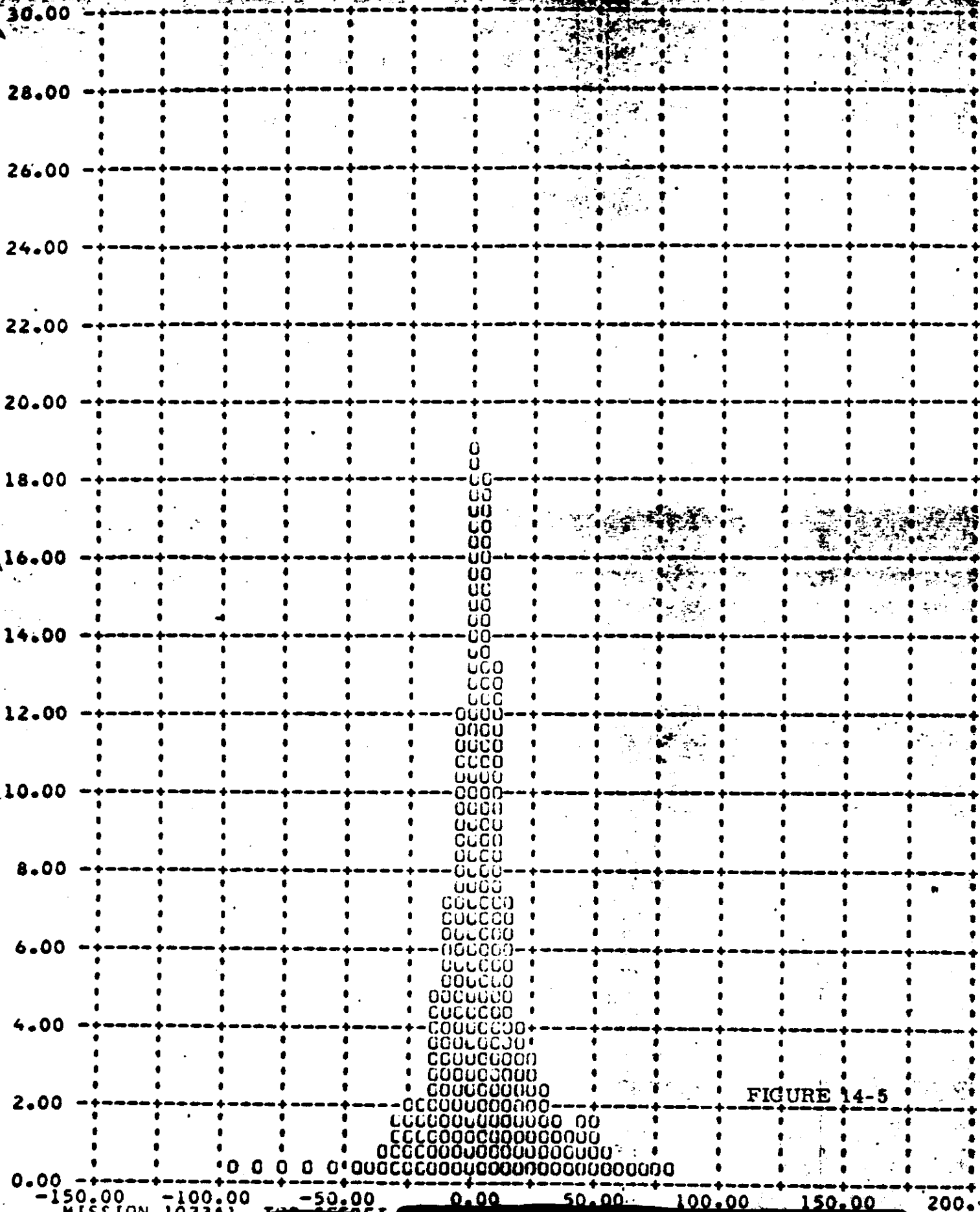

FIGURE 14-5

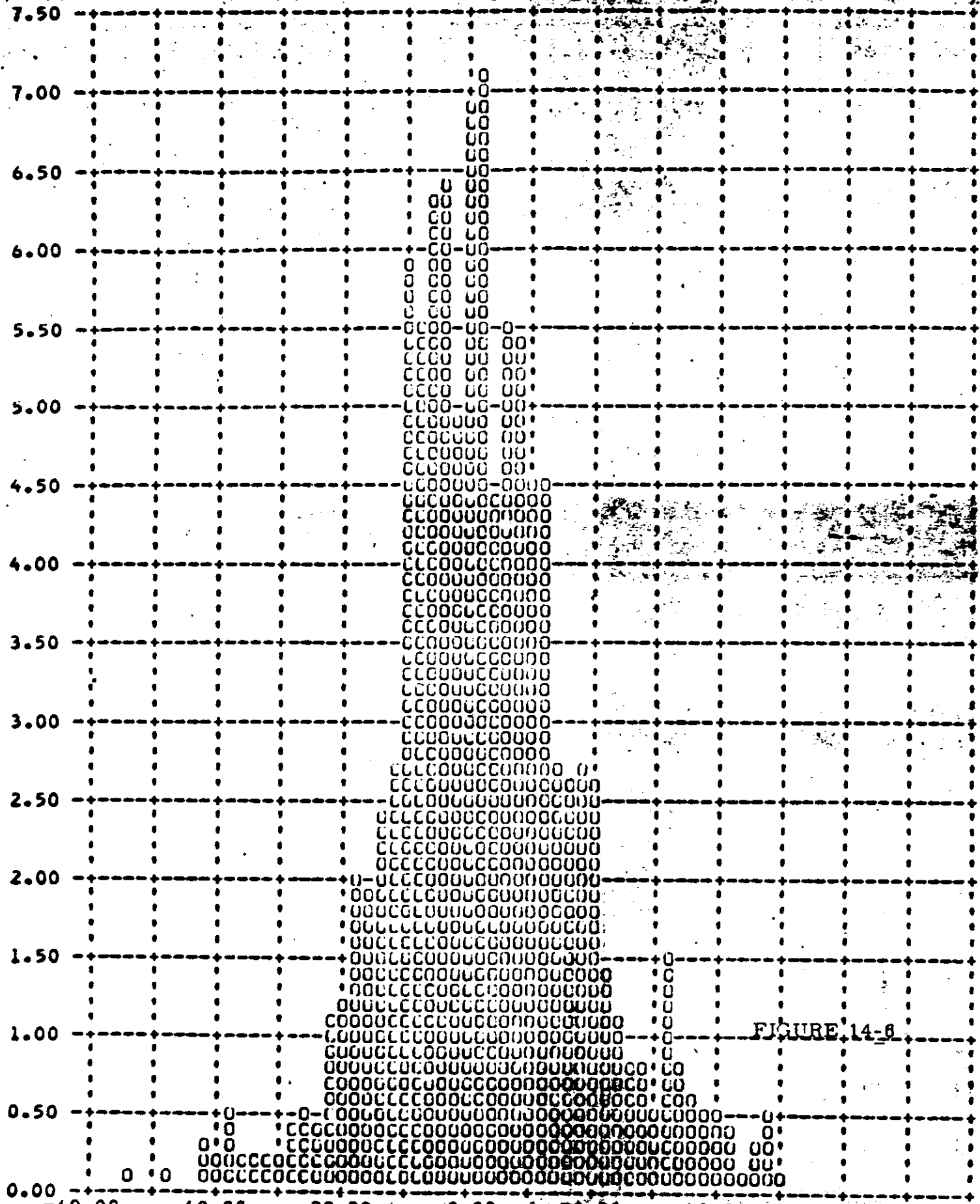
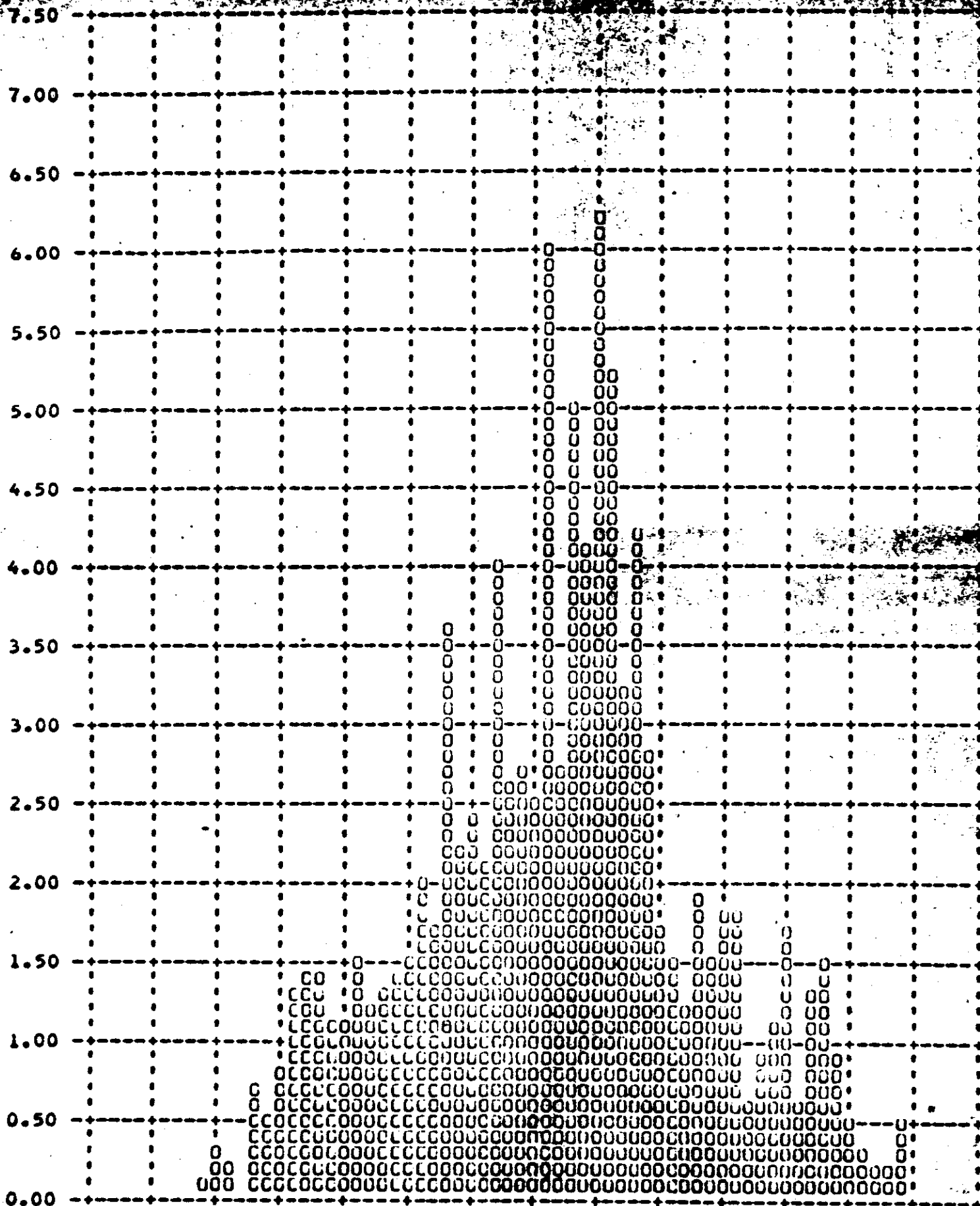

FIGURE 14-8

Y    PITCH ANGLE ERROR - DEGREES (X) VERSUS FREQUENCY - PERCENT (Y)



-0.60    -0.40    -0.20    0.00    0.20    0.40    0.60    0.80

MISSION 102381 TOP SECRET

Y ROLL ANGLE ERROR - DEGREES (X) VERSUS FREQUENCY - PERCENT (Y)

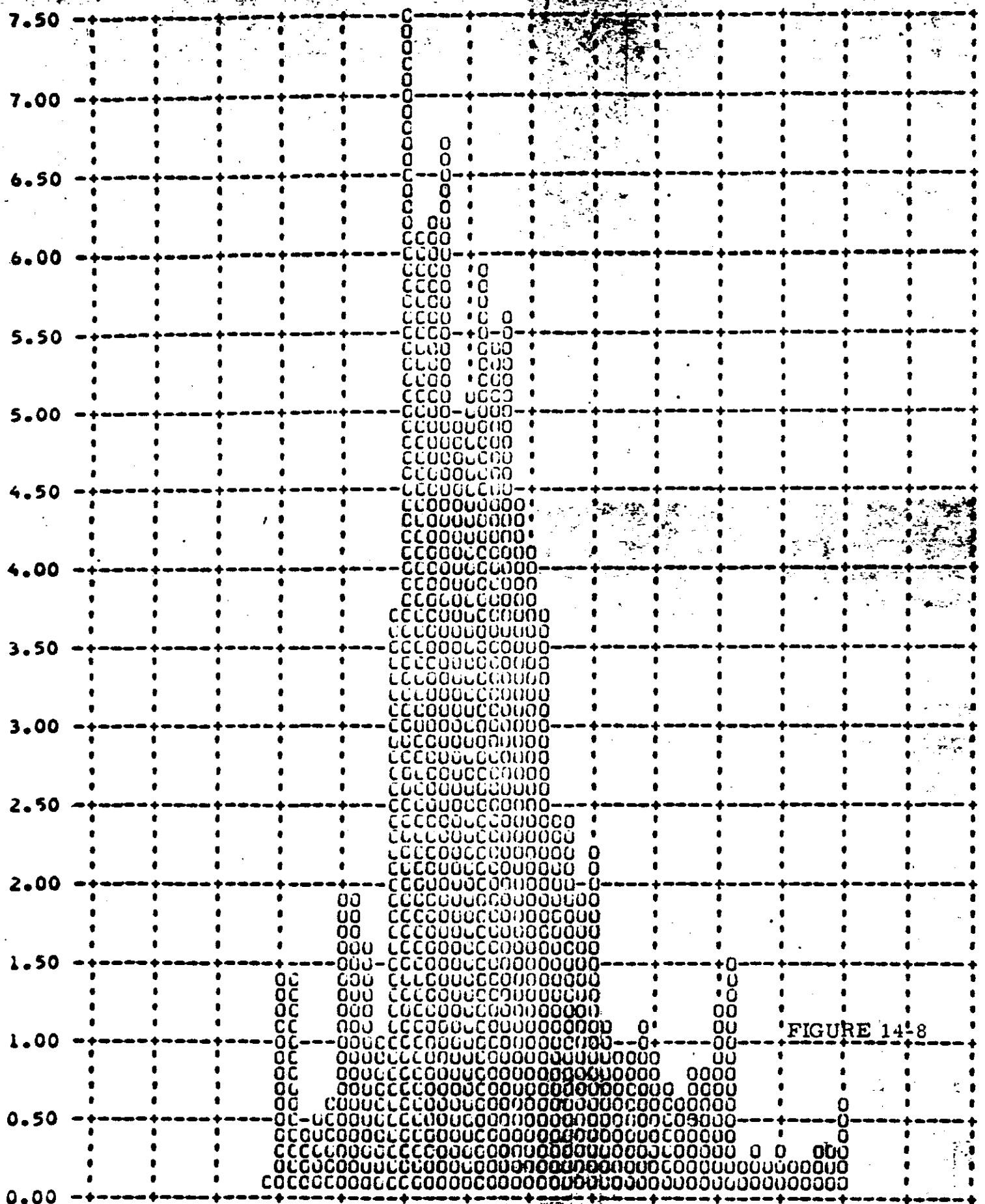

FIGURE 14-8



YAW ANGLE ERROR - DEGREES (X) VERSUS FREQUENCY - PERCENT (Y)

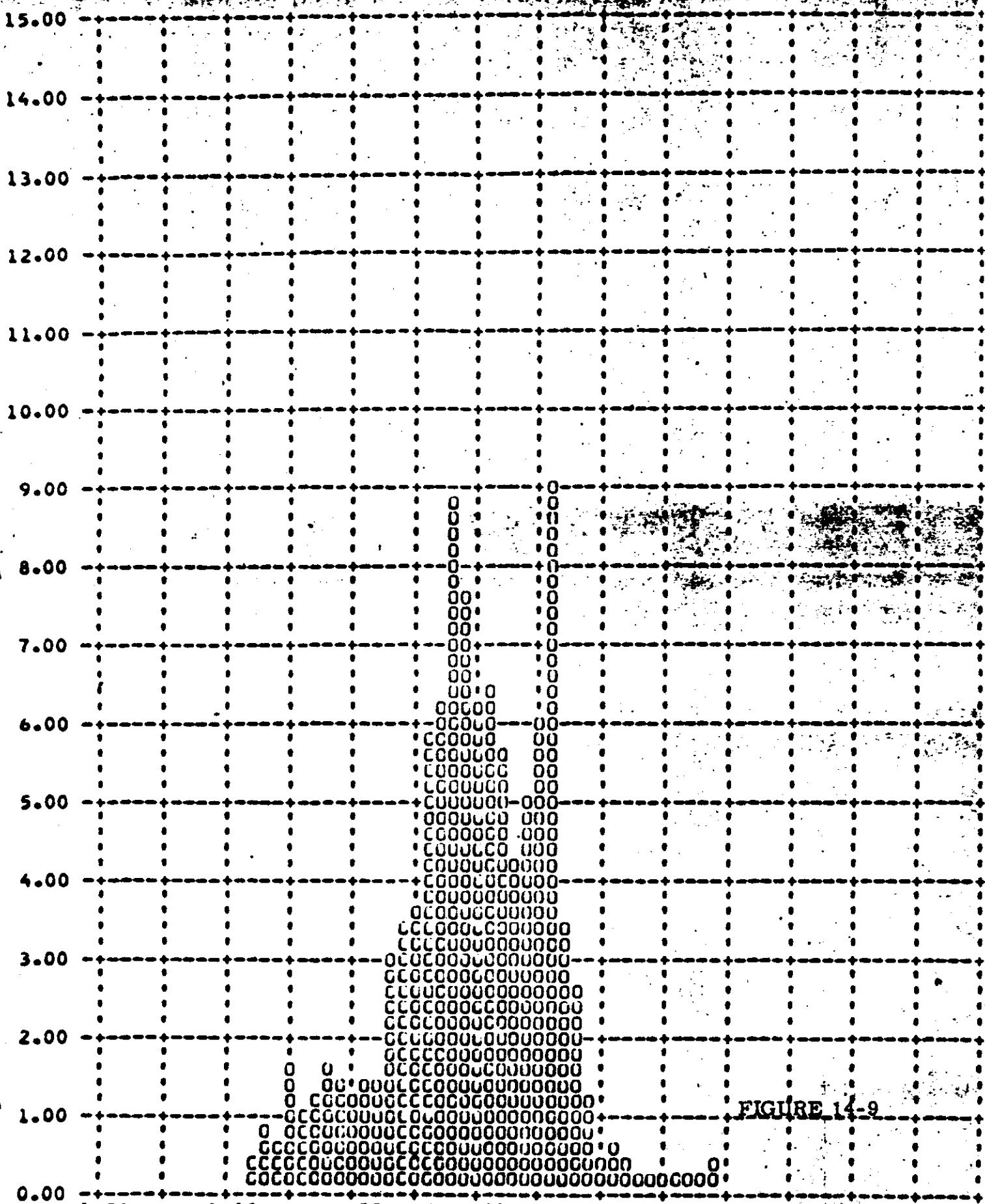

FIGURE 14-9

PITCH RATE ERROR - DEG/HOUR vs FREQUENCY - PERCENT

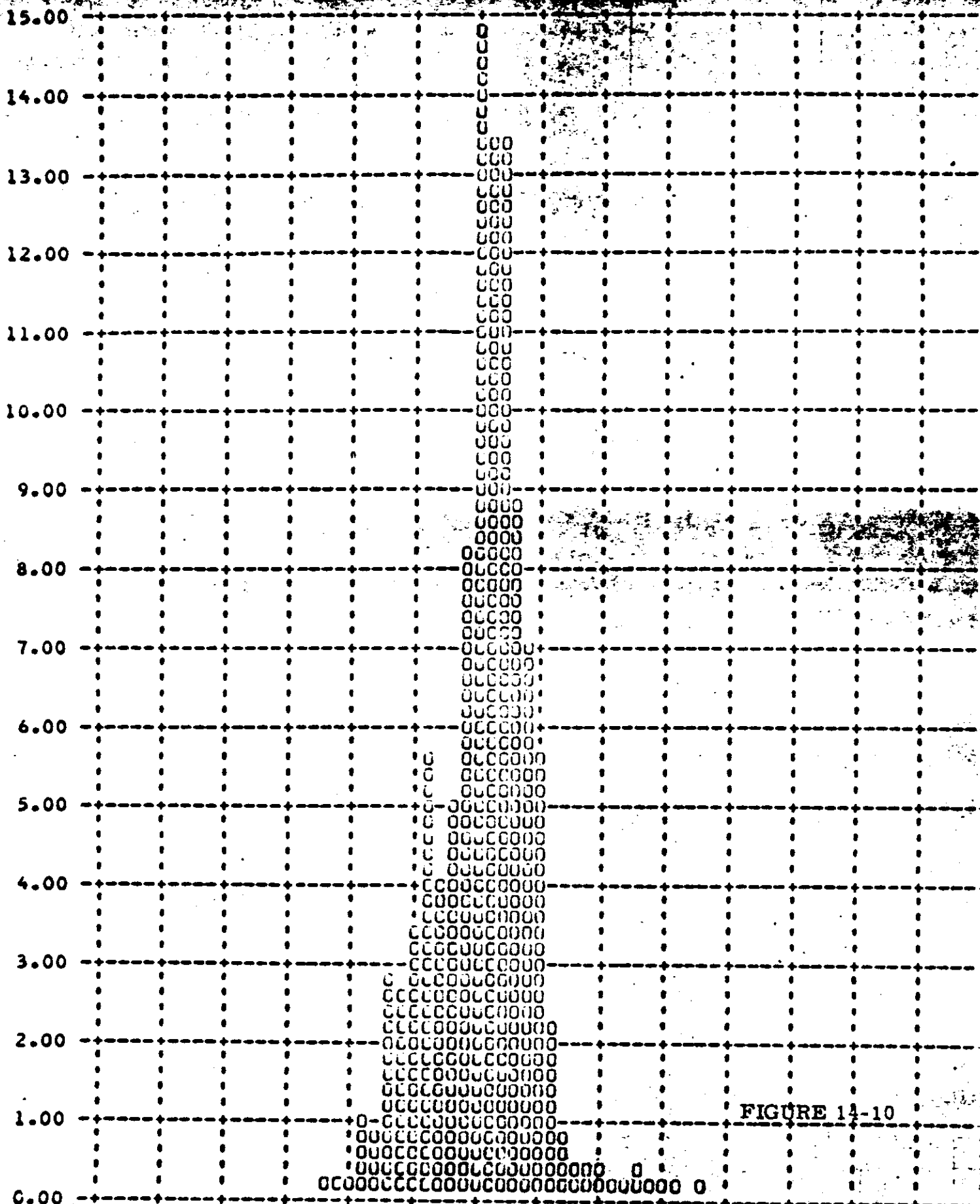

FIGURE 14-10

Y ROLL RATE ERROR - DEG/HOUR (X AXIS) FREQUENCY - PERCENT (Y)

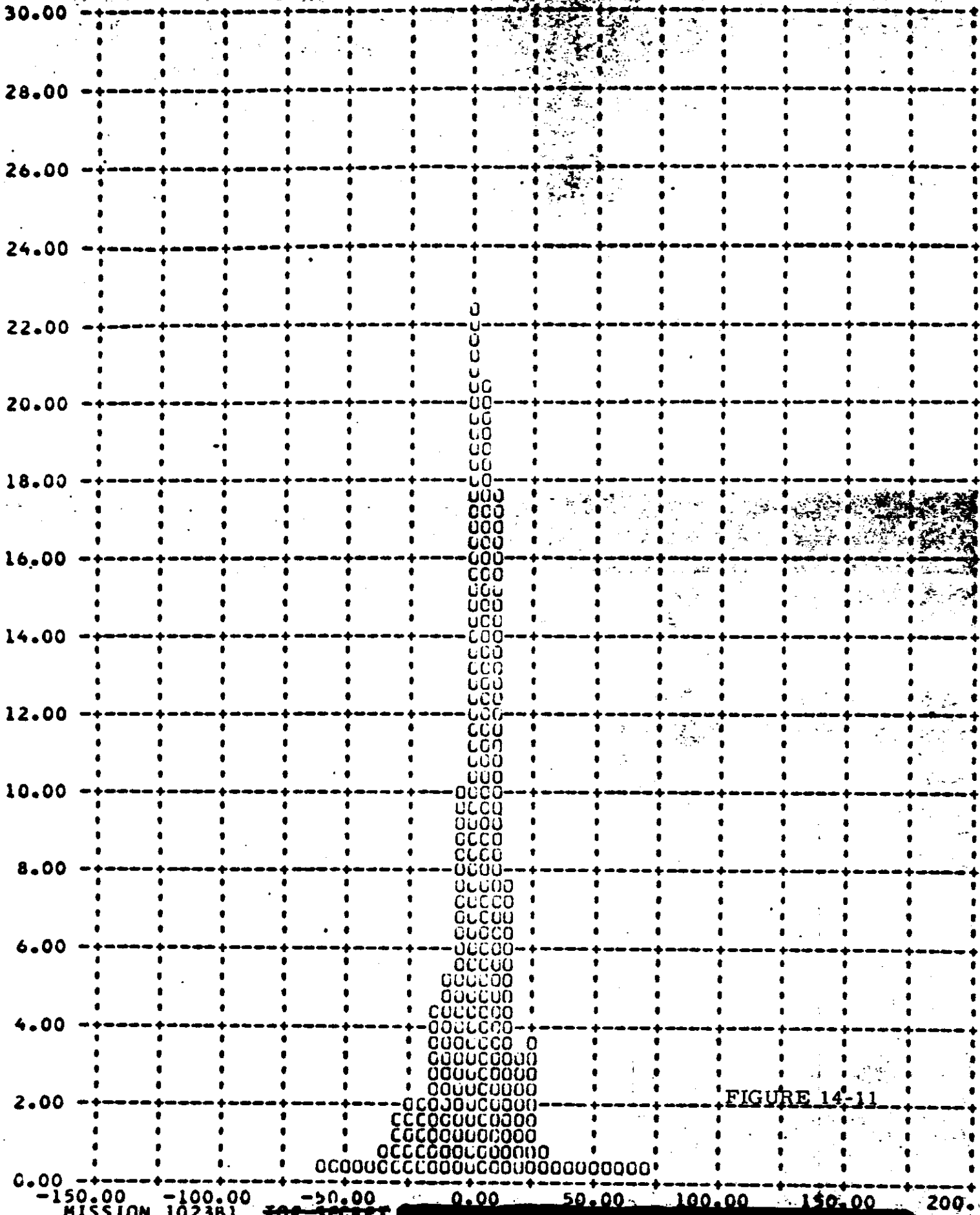

FIGURE 14-11

J-23 B BUCKET - FWD INSTR. FRAMES 1-6 OF EACH OF OMITTED 90 PERCENT - 28.5

YAW RATE ERROR - DEG/HOUR (X) VERSUS FREQUENCY - PERCENT (Y)

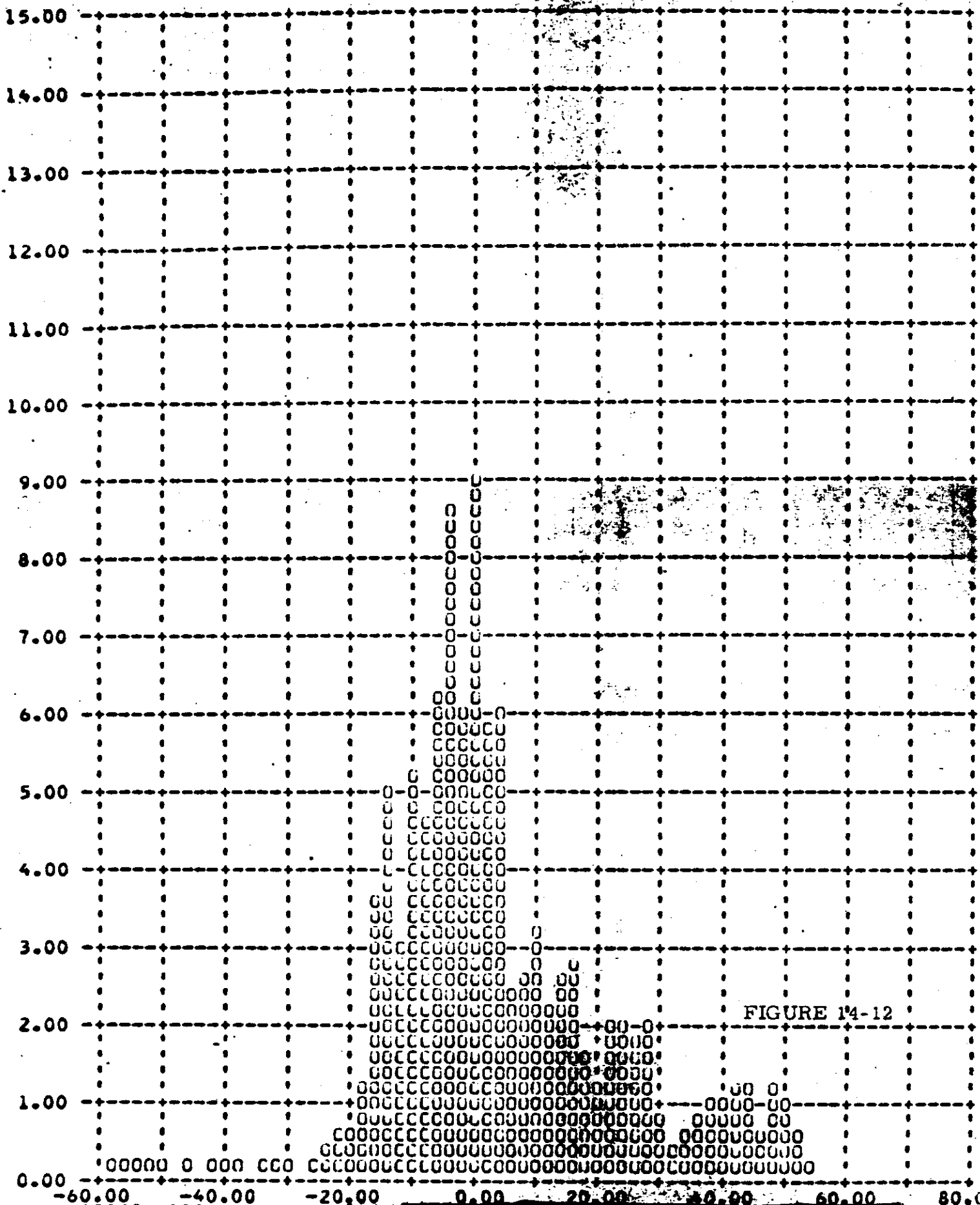

FIGURE 14-12

~~TOP SECRET~~

## SECTION 15

### IMAGE SMEAR ANALYSIS

The frame correlation tape supplied to A/P by NPIC contains the binary time word of each frame of photography. A computer program has been assembled at A/P which calculates the exposure time of each frame and compares the camera cycle rate with the ephemeris to calculate the V/h mismatch. This data is combined with the vehicle attitude error and rate values of each frame and the crab error caused by earth rotation at the latitude of each frame. The program outputs the total along track and cross track IMC error and the limit of ground resolution that can be acquired by a camera regardless of focal length and system capabilities.

The computer rejects the first six frames of all operations as the large V/h error induced by camera start-up is not representative of the overall system operations. The frequency distribution of the V/h errors and resolution limits for each panoramic camera have been calculated and plotted in Figures 15-1 through 15-2. The variation in the data for the panoramic cameras is the result of the different slit widths used during the mission and the resulting slower exposure time in the FWD camera.

The summary shown in Table 15-1 presents the maximum V/h ratio errors and resolution limits that existed during 90% of the photographic operations and the total range of values during all operations that were computed.

~~TOP SECRET~~

J-23 A BUCKET - END INSTR. FRAMES 1-6 OF EACH OP OMITTED 90 PERCENT

V/M RATIO ERROR - PERCENT (X) VERSUS FREQUENCY - PERCENT (Y)

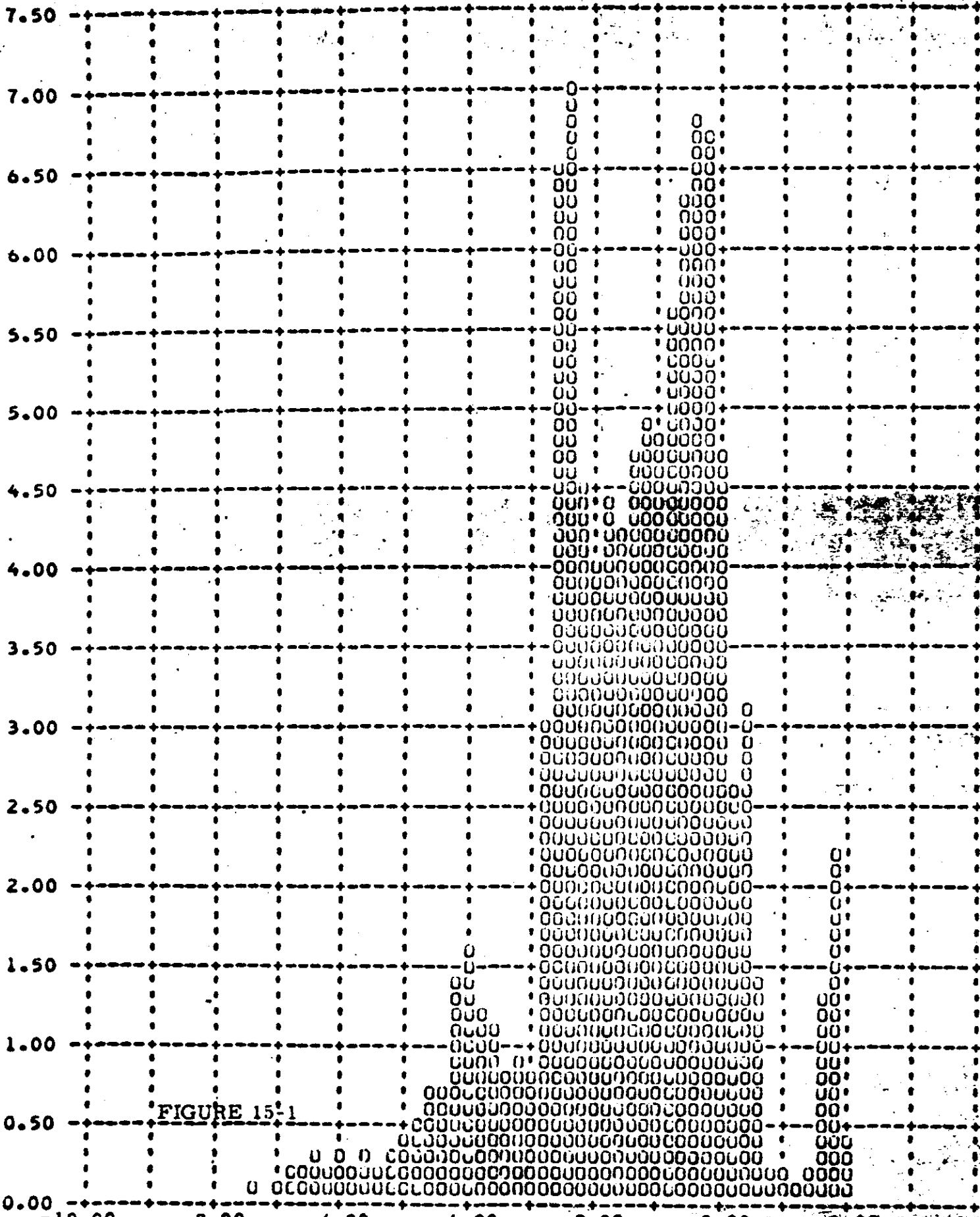

FIGURE 15-1

J-23 A BUCKET - AFT INSTR FRAMES 1-6 OF EACH OR OMITTED 90 PERCENT  
Y V/H RATIO ERROR - PERCENT (X) VERSUS FREQUENCY - PERCENT (Y)

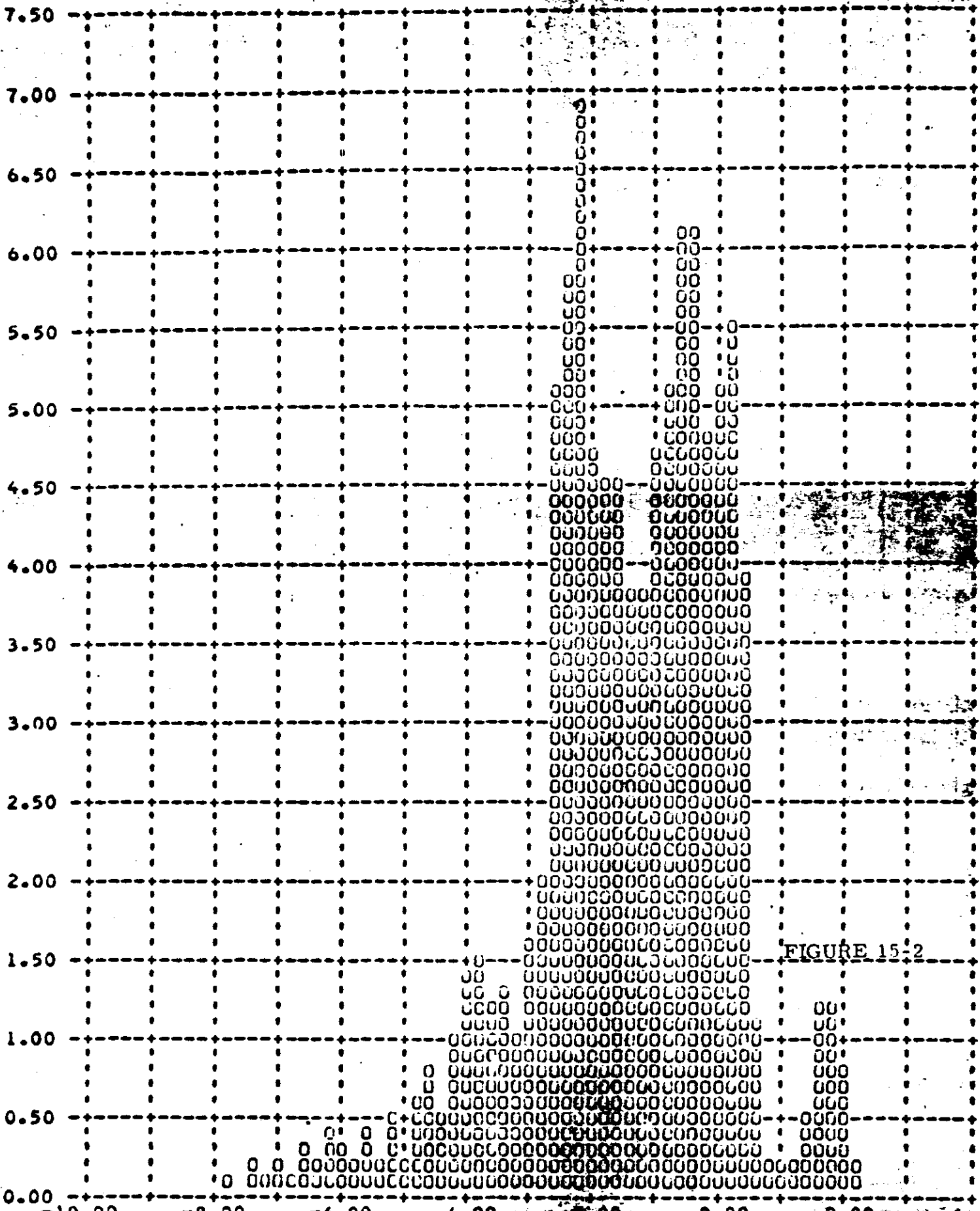

FIGURE 15-2

J-23 A BUCKET - FWD INSTR. FRAMES 1-6 OF EACH OR OMITTED - 90 PERCENT - 3.  
Y ALONG TRACK RESOLUTION LIMIT - FEET VERSUS FREQUENCY - PERCENT

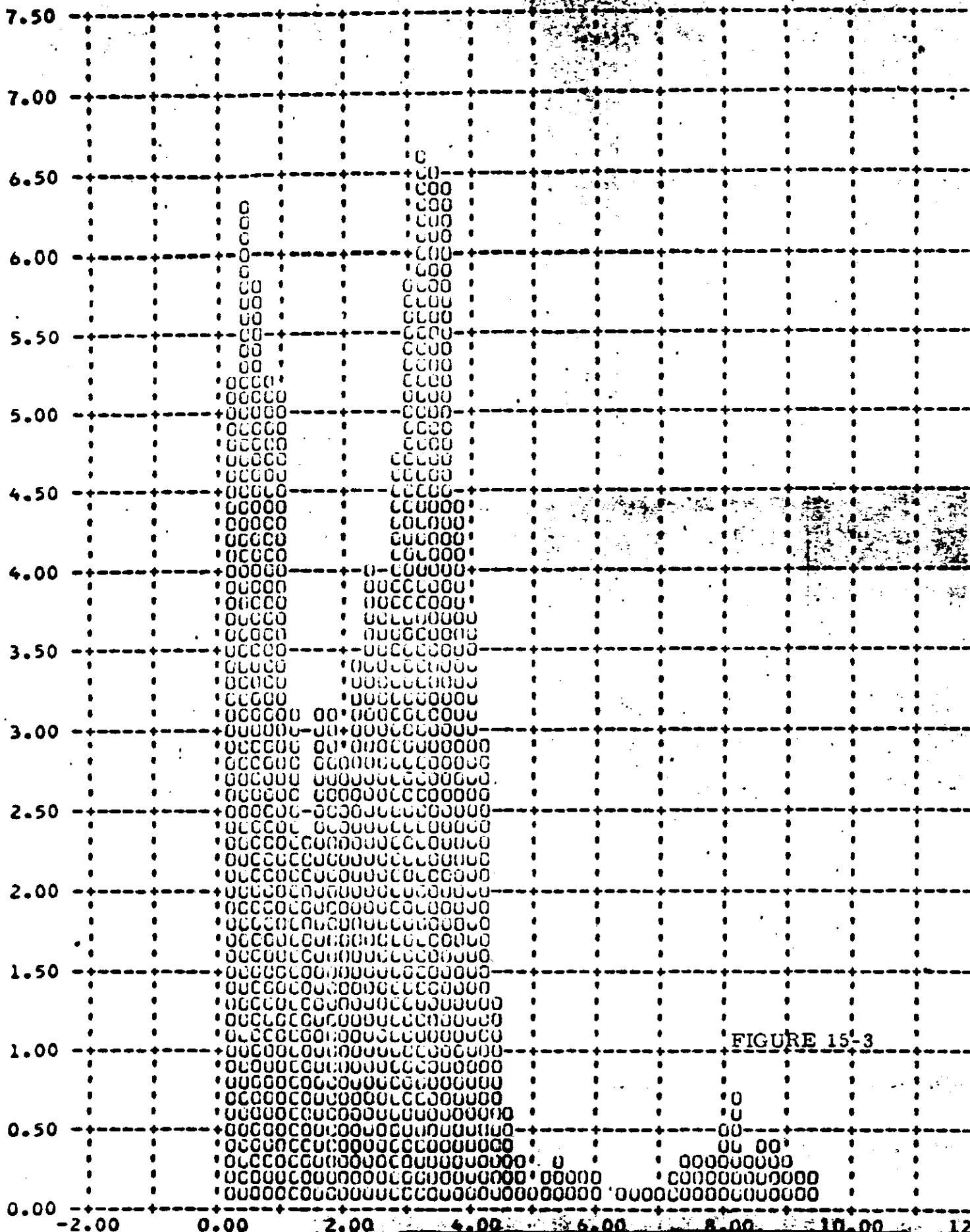

FIGURE 15-3



CROSS TRACK RESOLUTION LIMIT - FEET (X) VERSUS FREQUENCY - PERCENT (Y)

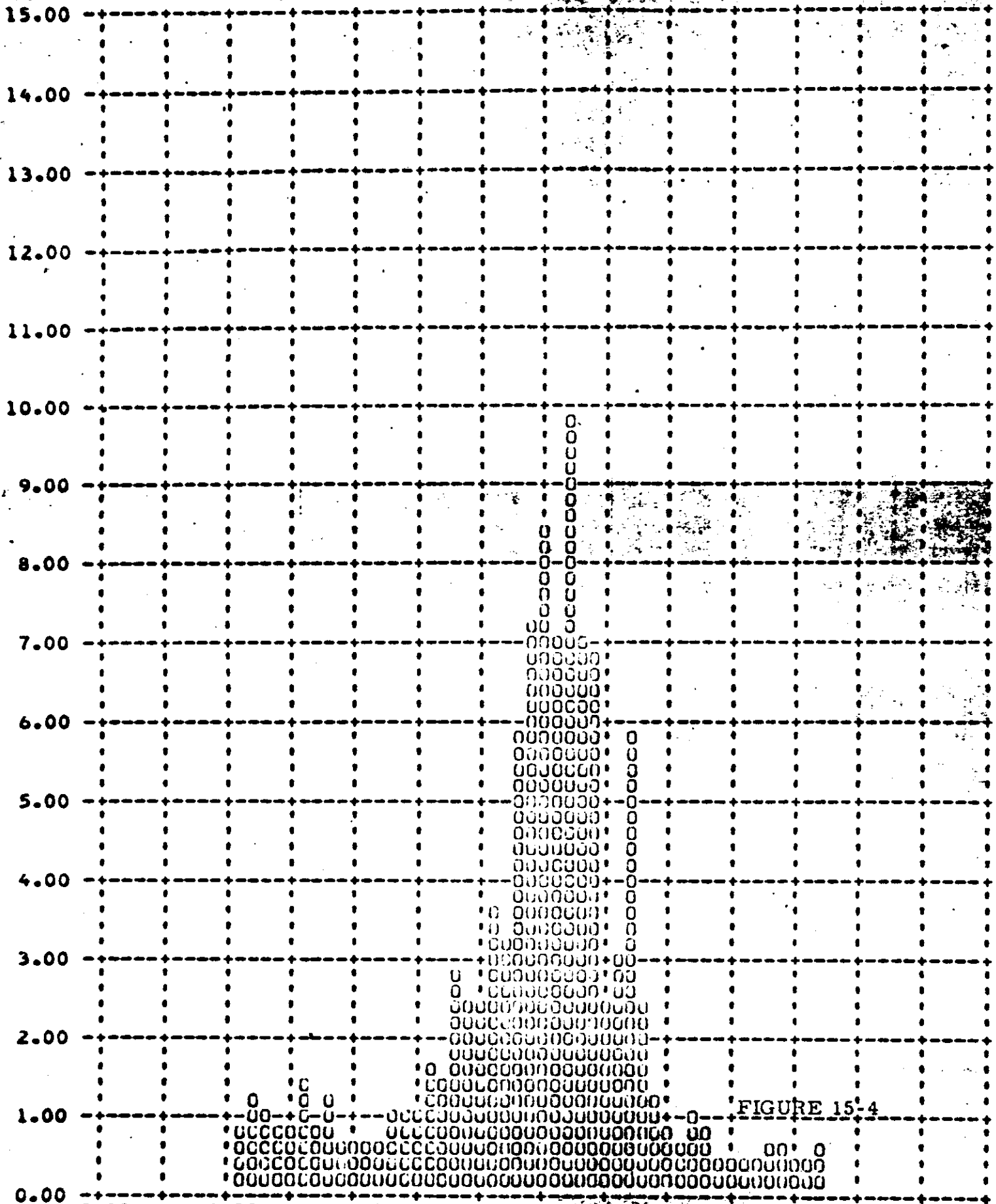

FIGURE 15-4

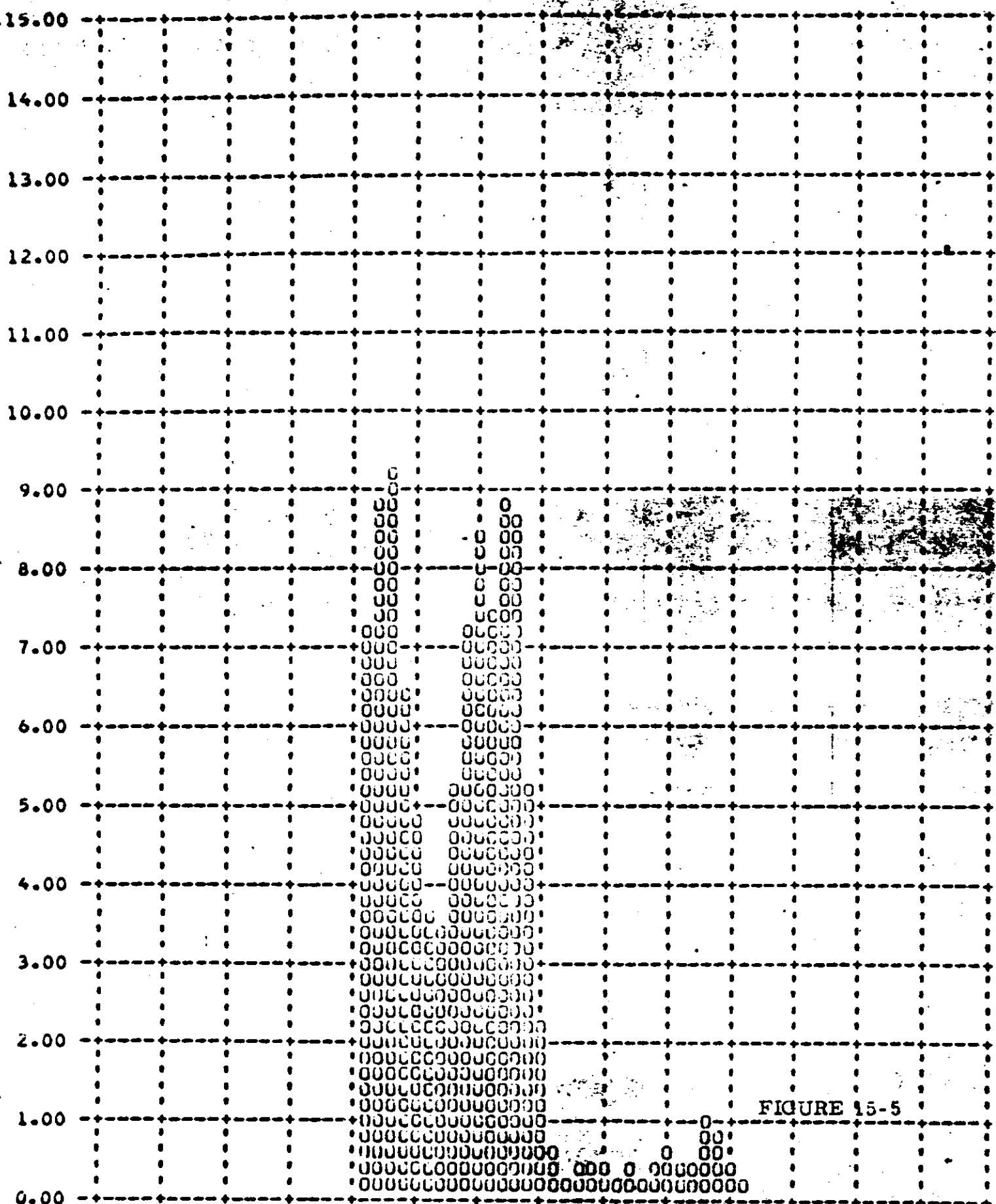

FIGURE 15-5

CROSS TRACK RESOLUTION UNIT - FEET (FT) VERSUS FREQUENCY - PERCENT

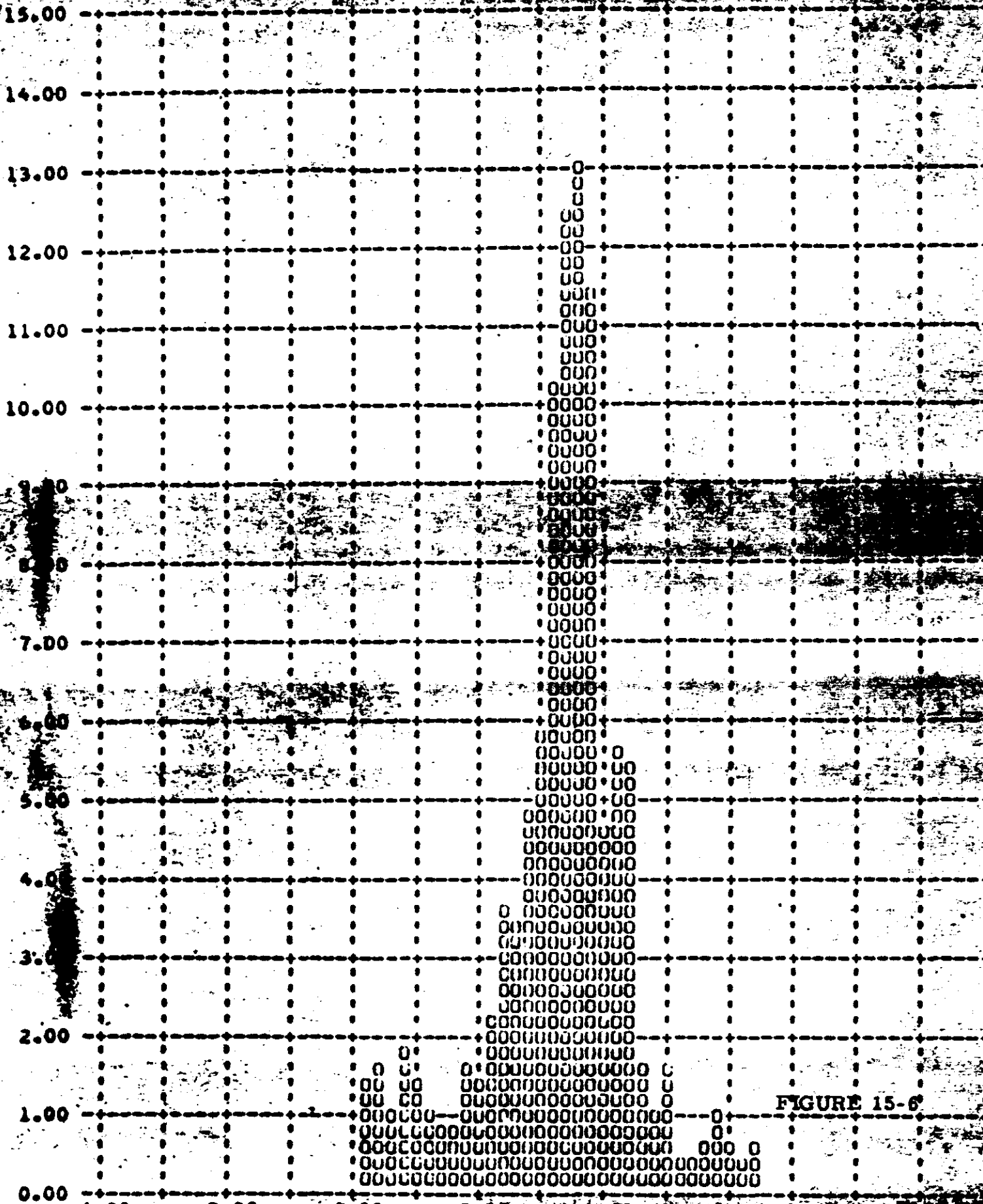

FIGURE 15-6

V/H RATIO ERROR - PERCENT (X) VERSUS FREQUENCY - PERCENT (Y)

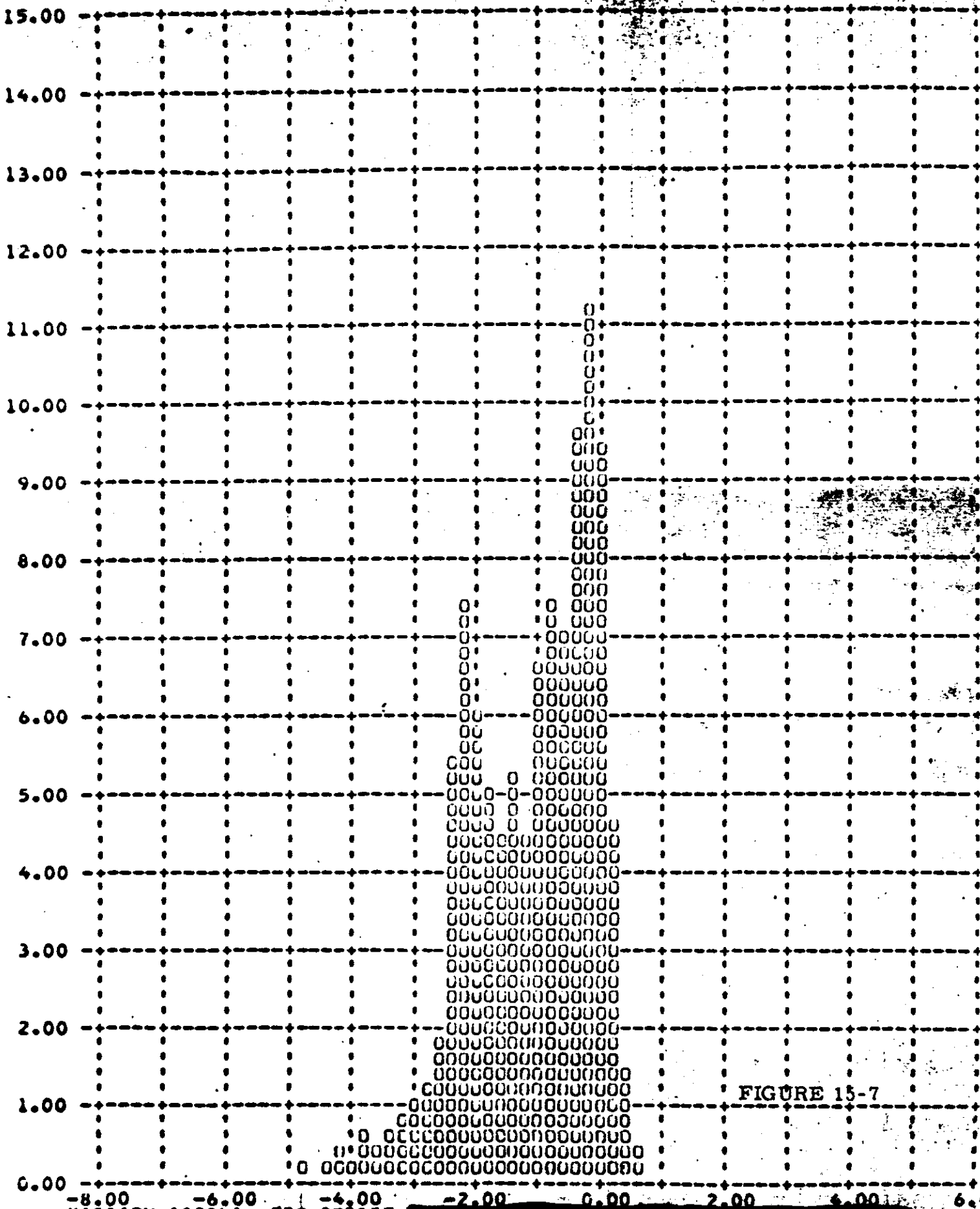

FIGURE 15-7

Y V/H RATIO ERROR - PERCENT (X) VERSUS FREQUENCY - PERCENT (Y)

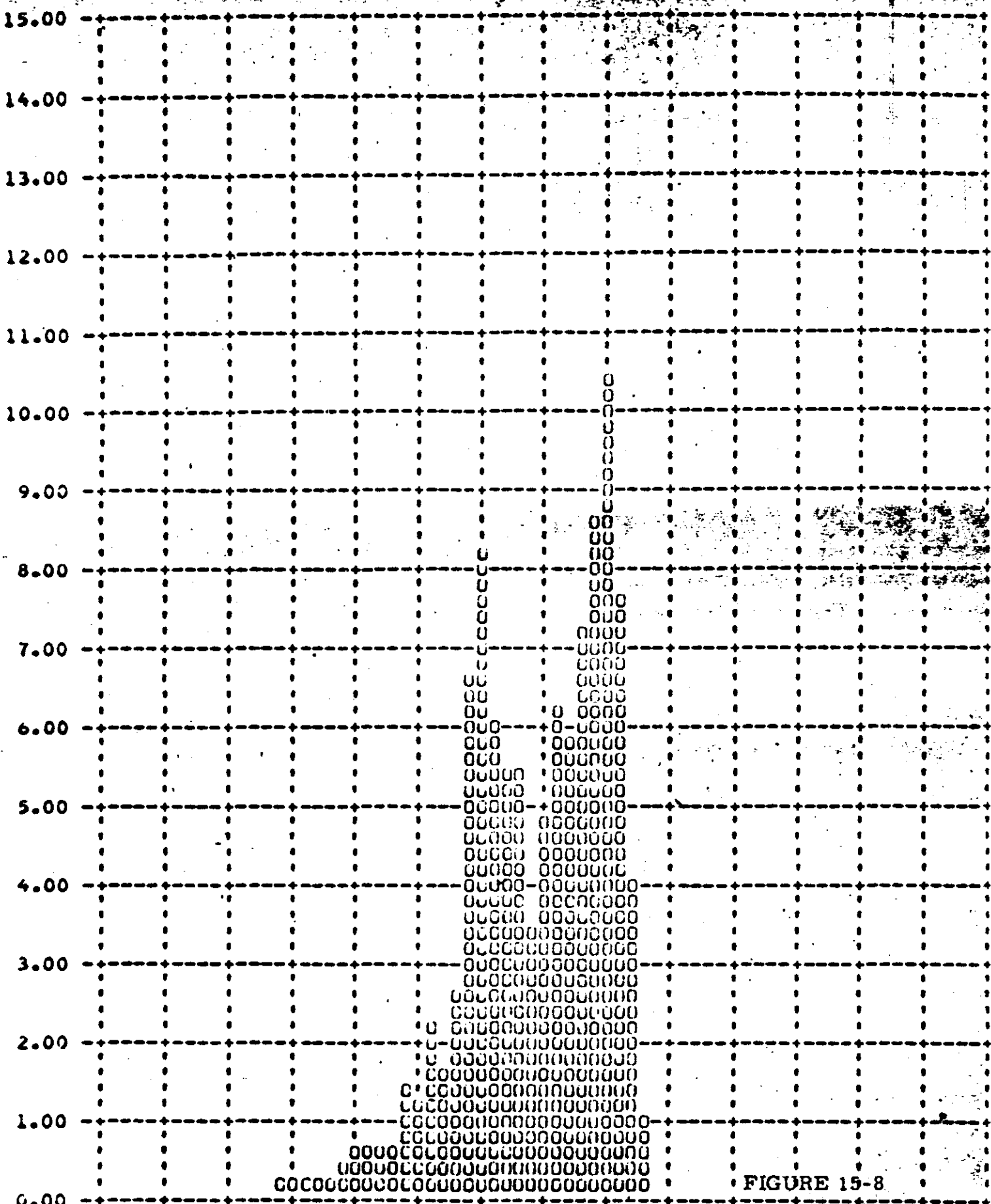

FIGURE 15-8

J-23 B BUCKET - FWD INSTR FRAMES 1-6 OF EACH OF LIMITED 90 PERCENT = 3.90  
Y ALONG TRACK RESOLUTION LIMIT - FEET (X) VERSUS FREQUENCY - PERCENT (Y)

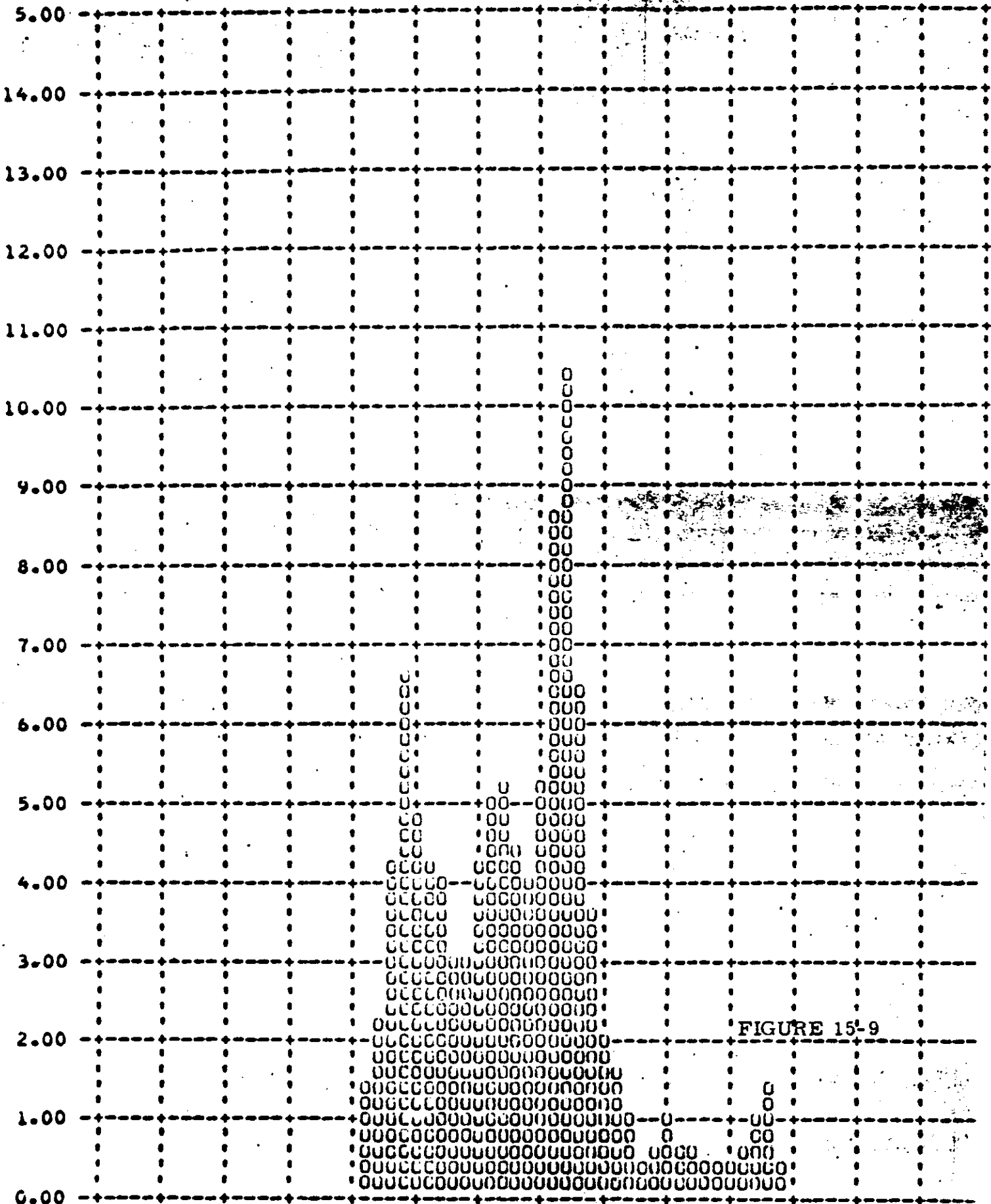

FIGURE 15-9

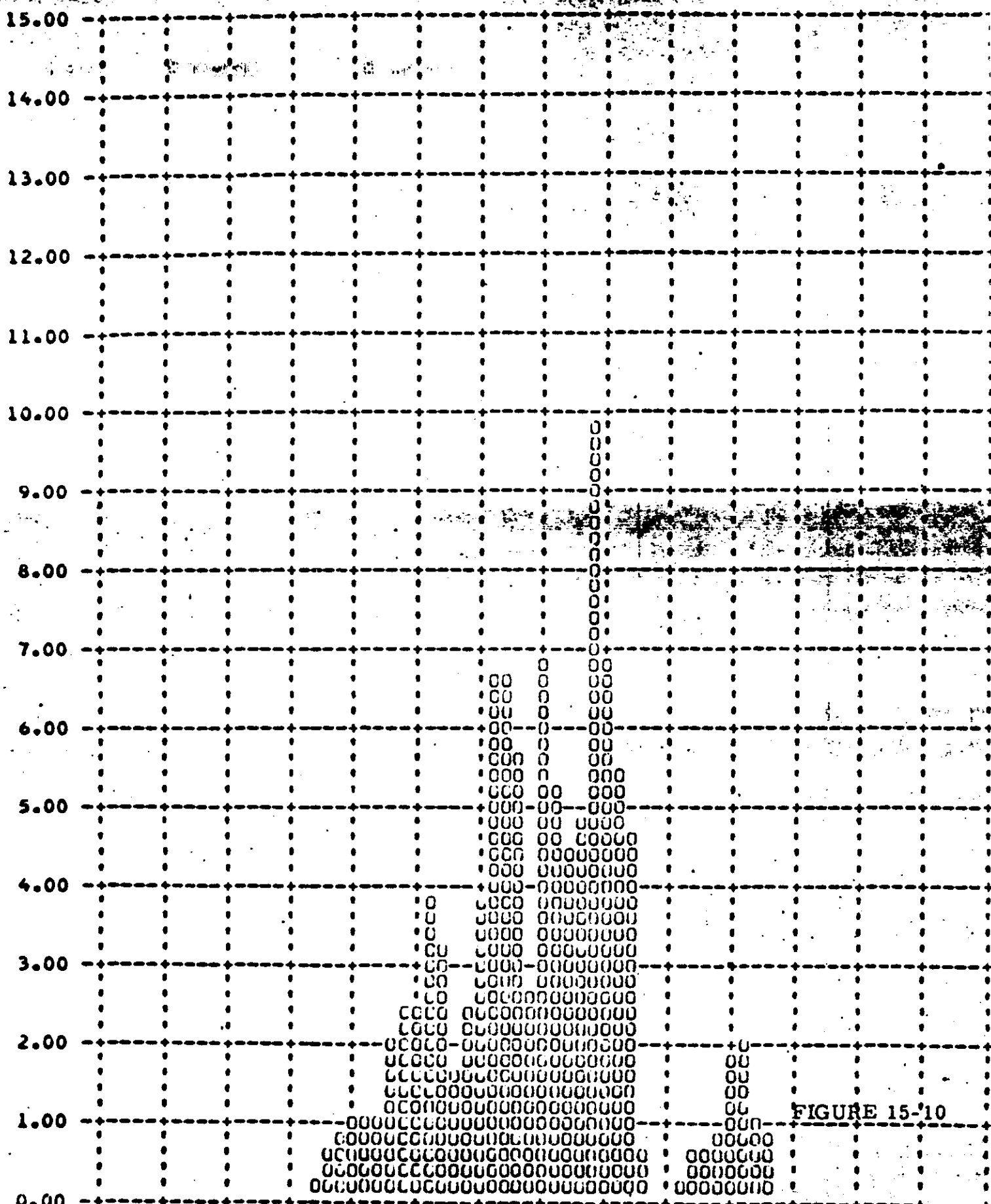

FIGURE 15-10

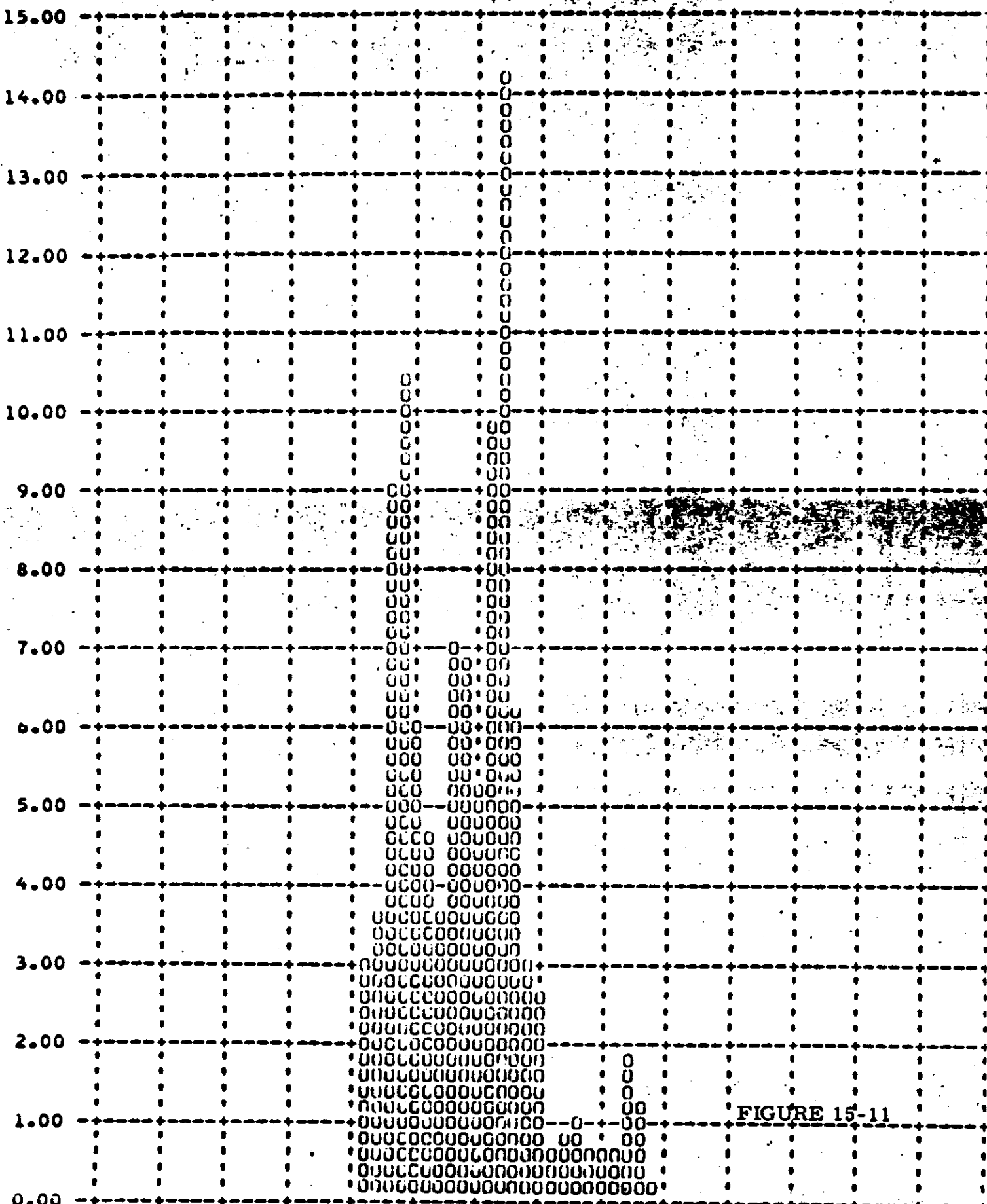

FIGURE 15-11



J-23 B BUCKET - AFT INSTR FRAMES 1-6 OF EACH OP OMITTED 90 PERCENT

Y CROSS TRACK RESOLUTION LIMIT - FEET (X) VERSUS FREQUENCY - PERCENT (Y)

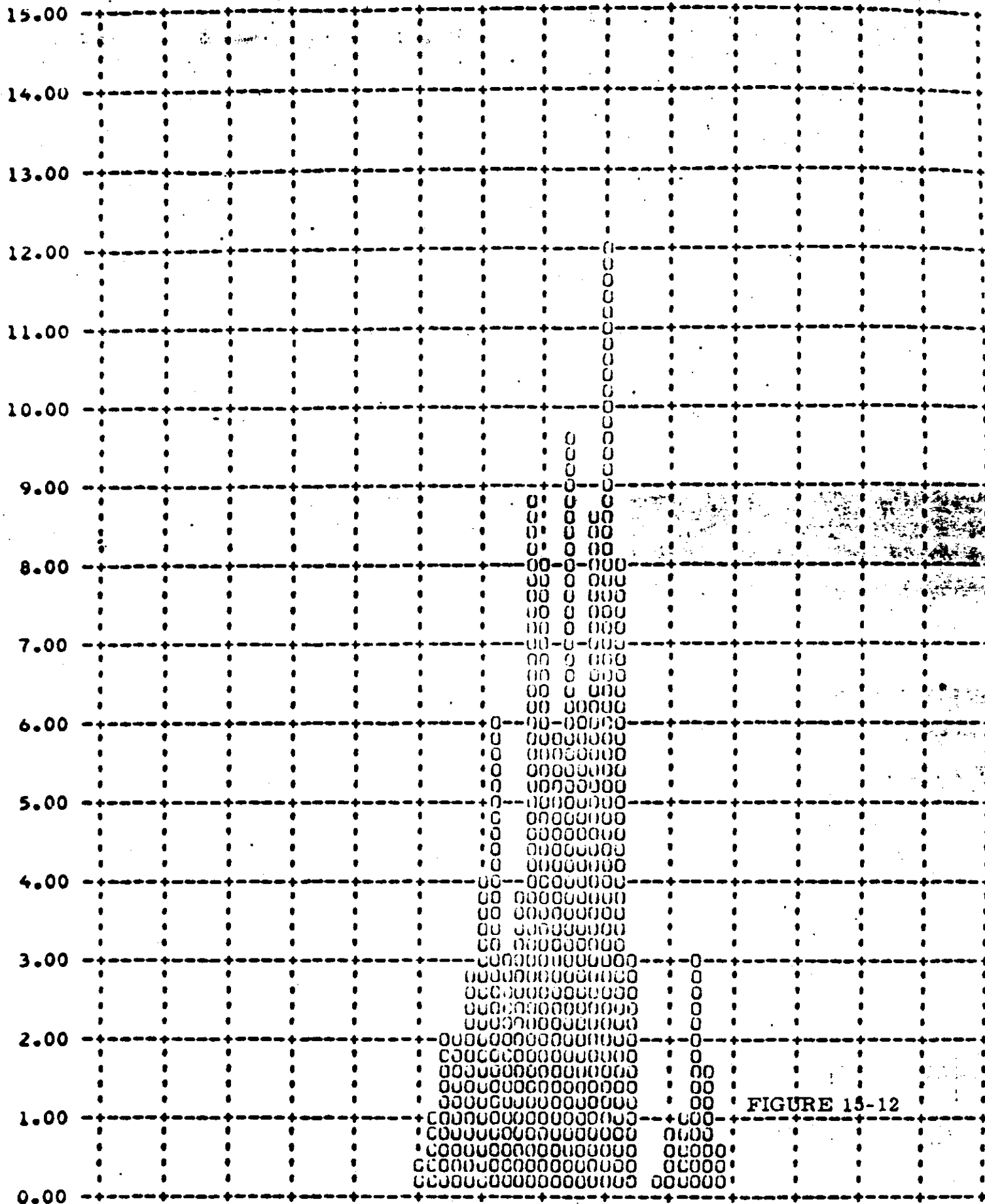

FIGURE 15-12

~~TOP SECRET~~

MISSION 1023

V/h RATIO AND RESOLUTION LIMITS

<u>Value</u>	<u>Units</u>	<u>Camera</u>	<u>Mission 1023-1</u>		<u>Mission 1023-2</u>	
			<u>90%</u>	<u>Range</u>	<u>90%</u>	<u>Range</u>
V/h Ratio Error	%	FWD	3.37	-7.4 to +2.0	2.45	-4.8 to +0.6
		AFT	3.50	-7.8 to +2.2	2.49	-5.2 to +0.6
Along Track Resolution Limit	Feet	FWD	3.9	0 to 9.4	3.9	0 to 6.8
		AFT	2.7	0 to 6.2	2.7	0 to 4.8
Cross Track Resolution Limit	Feet	FWD	6.4	0 to 9.4	6.3	1.4 to 8.6
		AFT	4.3	0 to 6.4	4.2	1.0 to 5.8

TABLE 15-1

~~TOP SECRET~~

SECTION 16

RADIATION DOSAGE

Each recovery system flown on a Corona mission contains a sealed packet of Eastman Type 4401 and Royal X Pan emulsions to determine the total radiation received at the take-up cassette. Both film types have been irradiated by LMSC at various levels and the base plus fog densities recorded after controlled processing.

Following recovery the film dosimeter packets are removed at A/P and processed with a pre-flight sample of the same film type and sensitometric control film. The resulting base plus fog density measurement of the dosimeter strips is used to ascertain the total radiation level. The table below presents the base plus fog readings for the dosimeter strips and the radiation level equivalents.

<u>Emulsion</u>	<u>Mission 1023-1</u>		<u>Mission 1023-2</u>	
	<u>B + F Density</u>	<u>Radiation</u>	<u>B + F Density</u>	<u>Radiation</u>
Type 4401	0.13	0.2 R	0.16	0.4 R
Royal X Pan	0.18	0.2 R	0.22	0.3 R

The mean total radiation seen by the take-up cassettes during both missions was approximately 0.3 roentgens. This level is somewhat less than received during recent missions and is well below the level that will degrade the panoramic photography.

SECTION 17

SYSTEM RELIABILITY

Reliability calculations for the payload are based on a sample beginning with M-7. Hence both the major part of the Mural Program and the "J" Program are covered in the calculation. For certain auxiliaries, i. e., the stellar-index camera and the horizon cameras, the sample size is changed to recognize incorporation of modified equipment or new designs where reliability was one of the principal reasons for the modification. However, for primary mission function, the sample size is consistent with reliability reporting for the vehicle.

The reliability estimates of this section deal exclusively with the payload. Failures to achieve orbit or vehicle induced failures are thereby excluded. Recoveries before a complete mission has been completed are considered as full missions providing that early termination was caused by reasons not connected with payload operation. Film quality is not considered in the reliability estimate calculation. Hence, only electrical and mechanical functioning are considered.

The reliability estimate is also divided into primary and secondary functions. The primary functions are operation of the panoramic cameras, main camera door operation, operation of the payload clock, and recovery operations. The secondary mission functions are horizon camera operation excluding catastrophic open shutter failure mode, auxiliary data recording, and stellar-index camera operation. A summary of estimated reliability is shown in Tables 17-1 and 17-2.

**Panoramic Camera Reliability**

Sample Size - 114 opportunities to operate.  
One failure - S/I Programmer on system J-19  
Assume - 3000 cycles per camera per mission  
Estimated Reliability = 98.6% at 50% confidence level.

**Main Camera Door Reliability**

Sample Size - 41 vehicles x 2 doors = 32 opportunities to operate  
Estimated Reliability = 99.2% at 50% confidence level.

**Payload Command & Control Reliability**

Sample size: 6000 hours operation  
Two failures .  
Estimated Reliability = 95.8% at 50% confidence level

**Payload Clock Reliability**

Sample size: 6000 hours operation  
No Failures  
Estimated Reliability = 98.9% at 50% confidence level.

Estimated Reliability of Payload Functioning on orbit: 96.2% at 50% confidence level

**Recovery System Reliability**

47 opportunities to recover  
1 failure - improper separation due to water seal - cutter failure.  
Estimated Reliability = 96.5% at 50% confidence level.

**Stellar-Index Camera Reliability**

Sample begins with J-5  
Sample size = 12,190 cycles  
Number of failures = 2  
Estimated Reliability = 91.1% at 50% confidence.

**Horizon Camera Reliability**

Sample includes J5 and up  
Sample size: 77,700 cycles  
Estimated Reliability of Single Camera = 98.0% at 50% confidence level.  
Estimated Reliability of Four Horizon Cameras at a Parallel  
Redundant System = 99.9% at 50% confidence level

# ESTIMATED RELIABILITY SUMMARY

(AT 50% CONFIDENCE LEVEL)

MISSION NUMBER	PRIMARY FUNCTIONS						SECONDARY FUNCTIONS									
	PANORAMIC CAMERA	PANORAMIC CAMERA DOORS	COMMAND & CONTROL SYSTEM	PAYLOAD CLOCK	ON-ORBIT FUNCTIONS	RECOVERY SYSTEM	STELLAR - INDEX CAMERAS	HORIZON CAMERAS	PANORAMIC CAMERA	PANORAMIC CAMERA DOORS	COMMAND & CONTROL SYSTEM	PAYLOAD CLOCK	ON-ORBIT FUNCTIONS	RECOVERY SYSTEM	STELLAR - INDEX CAMERAS	HORIZON CAMERAS
	SAMPLE FAILURES RELIABILITY	SAMPLE FAILURES RELIABILITY	SAMPLE FAILURES RELIABILITY	SAMPLE FAILURES RELIABILITY	SAMPLE FAILURES RELIABILITY	SAMPLE FAILURES RELIABILITY	SAMPLE FAILURES RELIABILITY	SAMPLE FAILURES RELIABILITY	SAMPLE FAILURES RELIABILITY	SAMPLE FAILURES RELIABILITY	SAMPLE FAILURES RELIABILITY	SAMPLE FAILURES RELIABILITY	SAMPLE FAILURES RELIABILITY	SAMPLE FAILURES RELIABILITY	SAMPLE FAILURES RELIABILITY	SAMPLE FAILURES RELIABILITY
1008 TO 1009	60 1 97.3	52 0 98.6	3124 0 98.0	3124 0 98.0	96.1	18 1 90.7	3400 3 83.1	18,000 0 91.7	60 1 97.3	52 0 98.6	3124 0 98.0	3124 0 98.0	96.1	18 1 90.7	3400 3 83.1	18,000 0 91.7
1009	64 1 97.4	54 0 99.7	3216 0 98.0	3216 0 98.0	96.2	20 1 91.9	4280 3 89.3	18,000 0 92.4	64 1 97.4	54 0 99.7	3216 0 98.0	3216 0 98.0	96.2	20 1 91.9	4280 3 89.3	18,000 0 92.4
1010	68 1 97.6	56 0 98.8	3432 0 98.1	3432 0 98.1	96.4	22 1 92.5	8100 3 73.7	18,000 0 94.4	68 1 97.6	56 0 98.8	3432 0 98.1	3432 0 98.1	96.4	22 1 92.5	8100 3 73.7	18,000 0 94.4
1011	72 1 97.7	58 0 98.9	3600 0 98.1	3600 0 98.1	96.8	24 1 93.0	5825 0 94.7	21,000 0 95.8	72 1 97.7	58 0 98.9	3600 0 98.1	3600 0 98.1	96.8	24 1 93.0	5825 0 94.7	21,000 0 95.8
1012	76 1 97.8	60 0 98.9	3720 0 98.2	3720 0 98.2	96.9	26 1 93.8	9025 0 94.7	24,000 0 96.8	76 1 97.8	60 0 98.9	3720 0 98.2	3720 0 98.2	96.9	26 1 93.8	9025 0 94.7	24,000 0 96.8
1013	78 1 97.8	62 0 99.0	3840 0 98.3	3840 0 98.3	96.0	28 1 94.0	8980 0 96.1	28,500 0 97.8	78 1 97.8	62 0 99.0	3840 0 98.3	3840 0 98.3	96.0	28 1 94.0	8980 0 96.1	28,500 0 97.8
1014	82 1 97.9	64 0 99.0	4006 0 98.3	4006 0 98.3	96.1	30 1 94.4	6378 1 89.8	28,900 0 98.9	82 1 97.9	64 0 99.0	4006 0 98.3	4006 0 98.3	96.1	30 1 94.4	6378 1 89.8	28,900 0 98.9
1015	86 1 98.0	66 0 99.0	4280 0 98.4	4280 0 98.4	96.1	32 1 94.8	7288 1 90.4	31,800 0 99.7	86 1 98.0	66 0 99.0	4280 0 98.4	4280 0 98.4	96.1	32 1 94.8	7288 1 90.4	31,800 0 99.7
1016	90 1 98.1	68 0 99.0	4660 0 98.5	4660 0 98.5	96.4	34 1 95.2	7480 1 91.0	34,900 0 99.8	90 1 98.1	68 0 99.0	4660 0 98.5	4660 0 98.5	96.4	34 1 95.2	7480 1 91.0	34,900 0 99.8
1017	94 1 98.3	70 0 99.1	4760 0 98.7	4760 0 98.7	97.6	34 1 95.4	8923 1 92.3	37,900 0 99.9	94 1 98.3	70 0 99.1	4760 0 98.7	4760 0 98.7	97.6	34 1 95.4	8923 1 92.3	37,900 0 99.9
1018	98 1 98.3	72 0 99.1	4820 0 98.7	4820 0 98.7	98.7	36 1 95.6	8960 1 92.3	40,800 0 99.9	98 1 98.3	72 0 99.1	4820 0 98.7	4820 0 98.7	98.7	36 1 95.6	8960 1 92.3	40,800 0 99.9
1019	102 1 98.4	74 0 99.1	5136 0 98.7	5136 0 98.7	98.8	38 1 95.8	8073** 1 91.9	43,900 0 99.9	102 1 98.4	74 0 99.1	5136 0 98.7	5136 0 98.7	98.8	38 1 95.8	8073** 1 91.9	43,900 0 99.9

\*\* DENOTES THE DENOTES PAYLOAD FAILURES OPERATIONS

TABLE 1

TOP SECRET

ON END SAMPLE OUT OF SERVICE

# ESTIMATED RELIABILITY SUMMARY

(AT 50% CONFIDENCE LEVEL)

TOP SECRET

MISSION NUMBER	PRIMARY FUNCTIONS												SECONDARY FUNCTIONS							
	PANORAMIC CAMERA		PANORAMIC CAMERA DOORS		COMMAND & CONTROL SYSTEM		PAYLOAD CLOCK		ON-ORBIT FUNCTIONS		RECOVERY SYSTEM		STELLAR - INDEX CAMERAS		FUNCTIONS					
	SAMPLE FAILURES	RELIABILITY	SAMPLE FAILURES	RELIABILITY	SAMPLE FAILURES	RELIABILITY	SAMPLE FAILURES	RELIABILITY	RELIABILITY	SAMPLE FAILURES	RELIABILITY	SAMPLE FAILURES	RELIABILITY	SAMPLE FAILURES	RELIABILITY					
1020	1	99.9	0	99.1	1	97.1	8844	0	99.9	0	0	43	1	96.1	10,000	2	99.9	48,000	0	97.9
1021	1	99.9	0	99.1	1	97.0	8376	0	99.8	0	0	41	1	96.0	9630	2	99.1	44,200	0	97.0
1022	1	99.9	0	99.2	1	97.3	8784	0	99.9	0	0	45	1	96.3	11,850	2	90.7	81,000	0	96.0
1023	1	99.9	0	99.2	2	98.6	8000	0	99.9	0	0	47	1	96.8	12,190	2	91.1	94,000	0	98.2

TOP SECRET

TABLE 1

~~TOP SECRET~~

SECTION 18

SUMMARY DATA

The comparison of the operating parameters and the performance achieved by previous missions has been difficult due to the large volume of data that results from each mission. Some of the pertinent characteristics from prior missions have been summarized in Tables 18-1 through 18-3

The summary data was started with Mission 1004 as the J-05 camera system was the first to incorporate the major modifications of the titanium drum and scan arm, four roller scan head and Corona J capabilities. Only those missions that culminated in the recovery of some photography have been listed, therefore Missions 1003 and 1005 are deleted.

~~TOP SECRET~~



# MISSION SUMMARY

MISSION NUMBER	PAYLOAD NUMBER	VEHICLE NUMBER	LAUNCH DATE	LAUNCH TIME	ORBIT INCLINATION (°)	BRIDGE		RECOVERY PASS	MASTER CAMERA		SLAVE CAMERA		STELLAR-HOZE CAMERA NUMBER		
						ALTITUDE (NM)	LOCATION (°N)		CAMERA NUMBER	SPLIT FILTER TYPE	CAMERA NUMBER	SPLIT FILTER TYPE			
1004	J-08	1174	2/18/64	2138 Z	74.3	99.9	89.0	49	124	0.250	W-21	125	0.250	W-21	040/02/45
1006	J-09	1176	6/4/64	2259 Z	79.3	84.0	63.2	88	148	0.200	W-21	149	0.200	W-21	040/07/45
1007	J-07	1009	6/19/64	2318 Z	85.0	99.2	41.8	88	144	0.250	W-25	145	0.200	W-21	040/07/45
1008	J-10	1177	7/10/64	2314 Z	85.0	99.4	40.8	49	150	0.200	W-21	151	0.200	W-21	040/08/45
1009	J-12	1008	8/3/64	2316 Z	80.1	99.6	39.8	49	154	0.200	W-21	155	0.200	W-21	040/08/45
1010	J-11	1178	9/14/64	2254 Z	84.9	97.4	42.5	66	158	0.175	W-21	153	0.175	W-21	040/08/45
1011	J-3X	1170	10/3/64	2150 Z	79.9	99.3	20.9	66	160	0.175	W-21	161	0.175	W-21	040/08/45
1012	J-13	1179	10/17/64	2202 Z	75.0	96.2	32.4	49	156	0.200	W-21	157	0.200	W-21	040/08/45
1013	J-16	1173	11/2/64	2130 Z	80.0	100.0	25.0	88	158	0.225	W-21	159	0.225	W-21	040/08/45
1014	J-16	1180	11/28/64	2036 Z	70.0	103.2	63.8	81	162	0.250	W-25	159	0.175	W-21	040/08/45
1015	J-17	1607	12/28/64	2110 Z	74.3	96.7	21.8	81	138	0.250	W-25	161	0.175	W-21	040/08/45
1016	J-18	1608	1/18/65	2101 Z	74.9	92.4	30.2	81	132	0.250	W-25	133	0.175	W-21	040/08/45
1017	J-14	1611	2/25/65	2144 Z	78.0	97.2	25.9	81	140	0.250	W-25	165	0.175	W-21	040/08/45
1018	J-18	1612	3/23/65	2111 Z	86.0	100.2	40.3	66	152	0.250	W-25	123	0.175	W-21	040/08/45
1019	J-04	1614	4/23/65	2144 Z	86.0	99.1	27.1	80	116	0.250	W-25	119	0.175	W-21	040/08/45
1020	J-20	1613	6/9/65	2158 Z	78.1	97.1	40.8	97	136	0.250	W-25	137	0.175	W-21	040/08/45
1021	J-21	1615	6/18/65	1823 Z	75.0	109.2	24.3	91	166	0.175	W-21	167	0.250	W-25	040/08/45
1022	J-22	1617	7/29/65	2203 Z	86.0	99.7	30.3	66	166	0.250	W-25	169	0.175	W-21	040/08/45
1023	J-23	1618	8/7/65	2100 Z	70.0	97.8	29.0	81	170	0.225	W-25	171	0.150	W-21	040/08/45

# PERFORMANCE SUMMARY

MISSION NUMBER	CAMERA P/W A/P	SERIAL NUMBER	M I P W/LG	VISUAL RES.	SLY (M)	AFSPPL MTP/AIM		SLY (M)	SLY (M)	SLY (M)	AVERAGE ALL	HIGH	90% ATTITUDE ERROR (°)			90% ATTITUDE RATES (DPR)			90% V/H ERROR (U)	SDX RECONSTRUCTION (M/T)		
						PITCH	ROLL						YAW	PITCH	ROLL	YAW	ALONG TRACK	CROSS TRACK				
1019-1	P/W A/P	118 119	85	81 89	—	—	—	80	83	80	88 87	104 101	0.43 0.44	0.35 0.37	0.97 0.96	31.8 31.8	34.7 34.9	33.0 33.1	3.3 3.8	9.3 9.3	9.1 9.1	
1020-1	P/W A/P	126	80	88	—	—	—	80	89	—	78	90	0.46 0.46	0.35 0.35	0.78 0.78	37.4 37.4	31.8 31.8	26.7 26.7	9.4 9.3	9.8 9.8	9.4 9.4	
1020-2	P/W A/P	137	—	—	—	—	—	80	—	—	—	—	0.41 0.17	0.17	—	42.6 42.6	23.8 23.8	42.5 42.5	3.8 3.4	4.2 4.2	4.2 4.2	
1021-1	P/W A/P	166	85	88 90	—	—	—	80	77	—	86	89	0.85 0.85	0.37 0.38	0.81 0.81	34.9 34.8	32.6 33.0	26.2 26.3	2.7 2.1	9.8 9.8	9.8 9.8	
1021-2	P/W A/P	107	85	85 74	—	—	—	80	74 82	—	88 88	—	0.89 0.65	—	—	44.7 50.6	—	—	—	—	—	—
1022-1	P/W A/P	100	85	88 91	—	—	—	80	85 83	—	79 101	91 111	0.47 0.47	0.51 0.51	0.89 0.90	28.3 27.9	27.1 26.6	23.8 23.8	3.8 3.0	9.8 9.8	9.8 9.8	
1022-2	P/W A/P	169	85	80 92	—	—	—	80	88 92	—	74 99	84 110	0.40 0.40	0.51 0.51	0.90 0.90	29.4 29.4	27.3 27.3	31.0 31.1	2.8 1.8	9.8 9.8	9.8 9.8	
1023-1	P/W A/P	170	85	—	—	—	—	80	94	—	87	110	0.49 0.49	0.33 0.33	0.50 0.50	33.0 32.9	28.7 28.7	23.5 23.5	3.4 3.8	9.8 9.8	9.8 9.8	
1023-2	P/W A/P	171	85	—	—	—	—	80	87 89	—	76 88	87 76	0.42 0.43	0.36 0.37	0.53 0.53	29.7 29.6	21.0 21.3	28.6 28.6	2.4 2.8	9.8 9.8	9.8 9.8	

TABLE 18-2

TOP SECRET

# EXPOSURE - PROCESSING SUMMARY

MISSION NUMBER	CAMERA	SOLAR ELEVATION RANGE (°)		SOLAR AZIMUTH RANGE (°)		PREDICTED PROCESSING (%)		REPORTED PROCESSING (%)		COMPUTED PROCESSING (%)		TERRAIN D-MIN			TERRAIN D-MAX			CLOUD RANGE			UNDER EXPOSED (%)	UNDER PROCESSED (%)	NOMINAL PROCESSED (%)	OVER PROCESSED (%)	OVER EXPOSED (%)	TOTAL NUMBER				
		LOW	HIGH	LOW	HIGH	P	F	P	F	P	F	LOW	HIGH	MEAN	LOW	HIGH	MEAN	LOW	HIGH	MEAN										
0010-4	PWD AFT	24 23	70 70	24 21	152 152	0 0	21 92	75 26	22 55	32 19	46 3	36 87	40 10	0.40 0.39	0.71 0.85	1.92 1.70	0.26 0.13	0.40 0.39	2.19 2.18	1.45 1.45	0.84 0.80	2.26 2.30	1.94 1.98	2.00 2.02	4 13	7 14	64 70	17 14	7 3	243
0020-4	PWD AFT	30 29	75 76	19 17	156 156	0 0	19 64	81 36	13 16	48 29	39 29	1 0	74	0.55 0.54	0.92 1.20	1.30 1.20	0.23 0.23	0.90 0.70	2.18 2.20	1.57 1.47	1.54 1.46	1.40 1.22	2.36 2.29	2.10 2.10	1 0	18 18	78 76	4 5	0 0	28
INSUFFICIENT DATA																														
0021-0	PWD AFT	16 14	66 66	-149 -147	-23 -26	0 0	68 99	32 1	14 18	39 38	47 47	0 0	52 87	0.64 0.87	1.90 1.70	0.25 0.17	0.76 0.85	2.16 2.16	1.50 1.42	0.97 1.06	2.36 2.33	1.92 1.85	2.00 2.00	5 5	9 13	72 68	11 12	3 3	28	
0021-2	PWD AFT	13 12	82 82	-43 -43	-41 -41	0 0	29 100	71 0	13 53	41 28	46 22	0 0	50 50	0.76 0.76	1.38 1.38	0.33 0.33	0.76 0.76	2.33 2.33	1.52 1.52	1.30 1.30	2.36 2.36	1.94 1.94	1.94 1.94	6 30	0 19	71 47	31 3	1 0	28	
0022-1	PWD AFT	23 27	67 67	30 26	180 150	0 0	36 89	64 11	8 42	36 51	56 0	0 0	42 53	0.40 0.60	1.49 1.48	0.43 0.37	0.43 0.39	2.52 2.50	1.87 1.63	1.60 1.68	1.32 1.30	2.55 2.47	2.24 2.25	19 4	15 28	47 35	3 1	0 0	28	
0022-2	PWD AFT	29 28	74 74	21 19	182 182	0 0	8 100	92 0	137 10	62 46	0 0	43 53	47 46	0.44 0.48	1.40 1.26	0.48 0.39	0.48 0.33	2.38 2.41	1.45 1.22	1.45 1.22	1.18 0.87	2.45 2.41	2.23 2.11	35 10	25 44	35 34	1 2	0 0	28	
0023-4	PWD AFT	22 20	82 81	8 6	164 163	0 0	5 11	95 89	19 0	54 39	27 61	0 0	72 42	0.36 0.48	1.26 1.40	0.39 0.33	0.36 0.48	2.41 2.31	1.22 1.31	1.22 1.37	0.87 0.94	2.41 2.45	2.06 2.15	20 13	14 14	34 68	2 7	0 0	28	
0023-2	PWD AFT	29 28	81 80	-13 -13	177 178	0 0	7 3	93 97	0 0	19 16	61 66	0 0	18 28	0.42 0.48	1.38 1.60	0.48 0.52	0.48 0.52	2.38 2.41	1.18 1.24	1.22 1.24	0.90 1.08	2.41 2.46	2.03 2.10	35 13	2 10	60 73	2 4	1 0	28	

TOP SECRET

TAB 1



Distribution:

